



**Industrial Hose**  
2015 Product Catalog

# Everything You Need

## Flexsteel® 250 EPDM-20 steam hose

With a maximum operating pressure of 250 psi and temperature range of -40°F to 450°F (-40°C to 232°C), Flexsteel 250 steam hose exceeds the RMA safety standard and makes steam operations more secure and user-friendly.



## Extremeflex™ Petroleum Transfer

An extremely flexible and lightweight hose for use in tank truck and drilling operation to transfer diesel, ethanol, gasoline, oil and petroleum-based products. Corrugated construction for lower drag coefficient and superior abrasion resistance.



## Survivor® compound

Featuring 2X the life on average\*, Survivor is one of the toughest cover compounds used on ContiTech conveyor belts. It is able to withstand serious abuse and still last longer.

# OILSAND

Excellent oil resistance plus abrasion resistance available as made to order with Hydrovator and other material handling hoses.



# READY 2 GO

## Ready 2 Go coupled hose assemblies

The R2G system has pre-coupled hose assemblies ready for delivery, so you wait less. And since it is available in seven different hose categories, you can rely on us to have the hose you need, when you need it.

\*Based on lab results from DIN test with non-rotating head versus abrasion-resistant SBR compounds. Service life may vary depending on application conditions.



# to Succeed

## LT fuel oil delivery hose

Perfect for transfer and delivery of fuel oil and petroleum products for home delivery, commercial and industrial service, this hose is designed to stay flexible in cold temperatures and provide superior oil resistance.



## Insta-Lock™ coupling hose systems

Insta-Lock coupling hose systems are designed with a cam & groove crimped coupling solution, developed to facilitate the use of crimped sleeves on industrial hoses by ContiTech. Available in aluminum, 316 SS and brass. Part A, B, C, D, E, F, dust plug, dust cap and jump sizes to meet your application needs.



## Flexsteel® Futura™ low perm dispensing hose

Get superior, long-lasting service with multi-fuel capability. This hose is designed for use at filling stations to reduce permeation rates to 10 g/m<sup>2</sup>/day and improve air quality and emissions.



## Crimping tools

We also offer a variety of crimping tools for on-site, in-vehicle and stationary applications. Available from 1/4" up to 12" ID to meet your industrial hose assembly needs.



# Industry-Leading Technology,

Continental ContiTech specializes in the engineering and distribution of innovative, reliable and high-performance industrial hose products for a vast array of industrial, commercial and residential applications.

## Air & Multi-Purpose

### General purpose



Industrial hoses with a wide range of multi-purpose applications from 1/4" to 2", -65°F to 275°F (-54°C to 135°C), compressors to jackhammers, 25 psi to 1000 psi.

- › Arctic Ortac®
- › Arctic Ortac® Plus
- › Braidair™
- › F5™
- › Frontier™ 200
- › Frontier™ 250
- › Frontier™ 300
- › Flexsteel® Service Station Air
- › Gorilla®
- › Jackhammer 200
- › Jackhammer 300
- › MIL A-A-59565
- › Variflex™ 200
- › Variflex™ 300
- › Nitrogen
- › Ortac® 250
- › Ortac® 300
- › Ortac® 400
- › Pliovic® FG (FDA-3A)
- › Pliovic® GS
- › Pliovic® Plus 250
- › Service Station Air

### Heavy duty



Industrial hoses with a wide range of multi-purpose applications from 1/4" to 2", -65°F to 275°F (-54°C to 135°C), compressors to jackhammers, 25 psi to 1000 psi.

- › Prospector™ Air
- › Prospector™ Air Plus

- › Plicord® Air Green 400
- › Plicord® Super Rock Drill
- › Steel Air
- › Super Ortac®

### Push-on



Specifically designed for the rigors of robotic, automated and pressurized applications. Temperature ranges from -40°F to 200°F (-40°C to 93°C), textile reinforcement, 3/16" through 1" ID.

- › Insta-Grip™ 250
- › Insta-Grip™ 300
- › Insta-Grip™ HT
- › Insta-Grip™ TC
- › Insta-Grip™ Plus

## Chemical Transfer



Engineered for reliable transfer of industrial chemicals and other solutions. Multiple cover color options, -40°F to 300°F (-40°C to 149°C), up to 200 psi WP.

- › Blue Flexwing®
- › Brown Flexwing®
- › Chem One™
- › DEF Transfer Hose
- › Fabchem™
- › Green XLPE
- › Hi-Per®
- › Orange Flexwing®
- › Plicord ExtremeFlex™ Brown
- › Plicord ExtremeFlex™ Purple
- › Purple Flexwing®
- › Viper®

## Cleaning Equipment



Engineered for reliable transfer of industrial chemicals and other solutions. Multiple cover color options, -40°F to 300°F (-40°C to 149°C), up to 200 psi WP.

- › Fortress® 300
- › Fortress® 1000
- › Fortress® 3000
- › Galvanator® 3000
- › Gauntlet® 1500
- › Gauntlet® 3000
- › Gauntlet® 4500
- › Neptune™ 1500
- › Neptune™ 3000
- › Neptune™ 4000-R
- › Neptune™ 4500
- › Neptune™ 6000
- › SpiraFlow®
- › Whitewater®

## Food

### Food transfer



Designed to handle nearly every type of dry bulk food material or liquids in plant and truck applications. With temperature ranges from -40°F to 230°F (-40°C to 110°C), FDA/3-A/USDA approvals.

- › Exstatic®
- › ExtremeFlex™ Beverage
- › ExtremeFlex™ Beverage w/EZ Clean Cover
- › Gray Flextra® LT
- › Harvest®
- › Nutriflex® Suction & Discharge
- › Nutriflex® Static Wire

# Reliability and Performance

- › Nutriflo® Suction & Discharge
- › Plicord® Blue Flour
- › Plicord® Brewline
- › Plicord® Clearwater
- › Plicord® ExtremeFlex™ Food Grade
- › Plicord® Gray Food
- › Plicord® Wineline
- › Pliovic® FG (FDA-3A)
- › Potable Water
- › Pyroflex® III Hot Air
- › Spirathane™ PT
- › Vintner™
- › White Flexwing®

## Food washdown



Designed for use in pressure washers and cleanup in food processing plants. Microban® protection available. Working pressures up to 1000 psi. Microban is a registered trademark of Microban U.S.A.

- › Blue Fortress® 300
- › Fortress® 300
- › Fortress® 1000
- › Fortress® 3000
- › Gauntlet® 1500
- › Plicord® Washdown
- › Sani-Wash™ 300
- › Sani-Wash™ Plus 300
- › Super Sani-Wash™ 300

## Marine



For multiple maritime applications. USCG and SAE approvals. From 1/4" up to 10" ID available.

- › Flexshield™ Marine Barrier Hose  
SAE J1527 USCG Type A1-15 / ISO 7840
- › Marine Fuel Feed Vent Hose  
USCG/SAE J1527 Type A2
- › USCG/SAE J1527 Type B2
- › Marine Fuel Line  
USCG/SAE J1527 & ISO 7840 Type A1
- › Plicord® Hardwall Wet Exhaust
- › Plicord® SAE J1527 Type A2 (fuel fill)
- › Plicord® Softwall Wet Exhaust

## Material Handling

### Abrasives



For industrial blasting, suction and high-pressure applications. Temperature ranges from -40°F to 190°F (-40°C to 88°C) and from 1/2" to 18" ID.

- › Artrac®
- › Arvac™ SW
- › Blucor™
- › Blucor™ Couplings
- › Diversiflex®
- › Diversipipe® 75
- › Diversipipe® 150
- › Flexible Downspout
- › Nutriflex® Static Wire
- › Plicord® Blast (2 ply & 4 ply)
- › Plicord® Dredge Sleeve
- › Plicord® Hydrovator
- › Plicord® RVC
- › Plicord® Sand Suction
- › Plicord® XF Blast (2 ply & 4 ply)
- › Sandblast Deadman
- › Spiraflex® Air Seeder Hose
- › Spirathane™ HD
- › Spirathane™ LD
- › Spirathane™ PT

## Bulk transfer



Designed for conveying air and materials in tank truck and plant services up to 150 psi with temperature ranges from -40°F to 400°F (-40°C to 204°C).

- › Black Softwall
- › FDA Hot Air
- › Flextra® Dry Material
- › Plicord® Torridair™ Hot Air Blower
- › Pyroflex® II Hot Air
- › Pyroflex® III Hot Air
- › Spiraflex® Mulch Blower
- › Tan Flextra®
- › Tan Flexwing®
- › Tan Softwall
- › FDA Hot Air

## Cement & concrete



Used to handle the transfer of sand, cement and other materials for construction industry applications. With textile or wire reinforcements and up to 1200 psi.

- › Allcrete® Textile  
(plaster, grout & concrete)
- › Allcrete® Wire
- › PGC Placement Textile
- › Plicord® Auger Arc Piling
- › Plicord® Gunitite (tan)



## Mining



Designed for a variety of applications in above-ground & underground mining application. Temperature ranges from -40°F to 200°F (-40°C to 93°C) and working pressures up to 1000 psi.

- › Brigade® Mine
- › Flextra® Rock Dust
- › M&P Mine Conduit
- › Mine Spray
- › Plicord® Ammonium Nitrate HD
- › Plicord® Ammonium Nitrate Pellet
- › Plicord® Mine Conduit
- › Spiraflex® Cable Guard
- › Spiraflex® Red
- › Spiraflex® Rock Dust
- › Spiraflex® Yellow (Spiraflex 2700)
- › TunnelCote™ Rock Dust

## Petroleum Aircraft fueling



For fueling or defueling of public and private aircraft. API/NFPA/EN standards, from 1/4" to 4" ID.

- › Advantage™
- › Deadman Aircraft Refueling
- › Jet Ranger™
- › Platinum JAC Riser
- › Refueling Sensing
- › Wingcraft™

## Petroleum dispensing



Heavy-duty hoses designed to dispense a wide range of fuels. Available in 5/8" to 1 1/4" ID.

- › Aggie Gas™
- › BC Cold Flex

- › BC Gasoline
- › BC Marina
- › DEF Dispensing Hose
- › Flexsteel® Futura® Ethan-ALL
- › Flexsteel® Futura®
- › Flexsteel® Futura® Low Perm
- › Flexsteel® Futura® HVR
- › Flexsteel® Futura® Vapor Assist
- › Maxxim™ Premier
- › Maxxim™ Premier Plus
- › Pacer™

## Petroleum dock hose



For transfer of petroleum-based products between docks and ships. From 3" to 12" ID and temperature ranges from -25°F to 350°F (-32°C to 177°C).

- › Flexdock® 225
- › Flexdock® 300
- › Hot Tar & Asphalt Rough & Smooth Bore
- › Plicord® Dock Hose
- › Smooth Bore Dock 200
- › Smooth Bore Dock 300
- › Tanker Barge Discharge
- › Vapor Recovery Dock

## Petroleum transfer



Designed for the transfer and delivery of fuel, oil and petroleum products for home delivery, commercial and industrial service applications. Working pressures up to 300 psi.

- › Arctic® ExtremeFlex™
- › Flexwing® Oilfield
- › Flexwing® VersaFuel
- › Hydrocarbon Drain Hose
- › Infinity™
- › Infinity™ HD
- › Blue Low Temp Fuel Oil Delivery
- › LW Arctic Tank Truck
- › Paladin®



- › Arctic Flexwing
- › ExtremeFlex Petroleum
- › Flexwing Petroleum
- › Fuel Discharge
- › Plicord® Oilfield Frac
- › Plicord® Super Black Flexwing
- › Pyroflex® Hot Tar & Asphalt II
- › Pyroflex® Hot Tar Wand
- › Red Flextra® 100 543-267
- › Red Flextra® 150 543-266
- › Redwing Fuel Oil
- › Spiraflex® Polyurethane Vapor Recovery

## Spray Hose



All-purpose hoses designed for a variety of paint and agricultural spray applications. Working pressures up to 800 psi.

- › Mine Spray
- › NR Spray
- › Pliovic® Ag Spray (1800 & 2400)

## Steam Hose



Designed for industrial applications requiring the transfer of steam. Flexsteel® available with crimped fitting solutions.

- › Flexsteel® 250 CB Extreme
- › Flexsteel® 250 CB Steam
- › Flexsteel® 250 Steam
- › Flexsteel® 250 EPDM-20
- › Heavy Duty Steam Pile Driver
- › MIL-DTL-29210E
- › Plicord® 250 Steam

## Vacuum Hose



For a wide variety of applications including leaf collection, manhole blowers and exhaust fumes. Available in 1½" to 8" ID.

- › Arvac™ SW
- › Plicord® HD Industrial Vacuum
- › Plicord® Vacuum (HD & LW)
- › Spiraflex® Ducting

## Continental ContiTech

- › Spiraflex® Grassvac
- › Spiraflex® Vacuum
- › Spirathane® HD
- › Spirathane® LD
- › Spirathane® PT

## LPG delivery pro hose



Designed for residential and commercial delivery and transfer applications of liquid propane gas. Working pressures up to 300 psi and temperature ranges from -40°F to 180°F (-40°C to 82°C).

- › LPG Delivery Pro®

## Water Discharge hose



Designed for mining, construction, industry, agricultural and marine service applications. Temperatures up to 190°F (88°C) and available in 1/2" to 12" ID.

- › Brigade™ Mine
- › Contractors Water

- › Fire Engine Booster
- › Pathfinder® Garden Hose
- › Plicord® Furnace Door
- › Plicord® HD Water Discharge
- › Plicord® Versiflo® 125
- › Prospector™ Water Discharge 150
- › Potable Water
- › Spiraflex® Black (Lay-Flat Super Duty Hose)
- › Spiraflex® Blue (Extra Light Duty)
- › Spiraflex® Gray (Light Duty)
- › Spiraflex® Red (Medium Duty)
- › Spiraflex® Yellow (Heavy Duty)
- › Sureline®

## Suction & discharge Hose



Designed for mining, construction, industry, agricultural and marine service applications. Temperatures up to 190°F (88°C) and available in 1/2" to 12" ID.

- › Cold Blue
- › Green Hornet® XF
- › Flexwing® Water S&D
- › Prospector™ Water S&D
- › Spiraflex® 1600
- › Spiraflex® Aggie PVC
- › Spiraflex® HT
- › Versiflo® 150 Water S&D

## Washdown hose



General-service hoses for a wide range of industrial, construction and agricultural water discharge. From 1/4" - 1½" ID and temperatures up to 200°F (93°C).

- › Fortress® 300
- › Fortress® 1000
- › Fortress® 3000
- › Gauntlet® 1500
- › Plicord® Washdown
- › Pulp & Paper Washdown
- › Sani-Wash™ 300
- › Sani-Wash™ Plus

- › Super Sani-Wash® 300
- › Sureline®

## Welding Hose



Designed for a variety of welding services and applications for Grade R, RM, T. Available in single and Twin Line options.

- › Twin Line Welding (Grade R)
- › Twin Line Welding (Grade RM)
- › Twin Line Welding (Grade T)
- › Single Line Welding (Grade R)
- › Single Line Welding (Grade RM)
- › Single Line Welding (Grade T)
- › TIG Welding

See our line of Prospector™ hose in our Oil & Gas brochure.







# Application Warning

---

**The products in this catalog have been tested under controlled laboratory conditions to meet specific test criteria. These tests are not intended to reflect the performance of the product or any other material in any specific application, but are intended to provide the user with application guidelines. The products are intended for use by knowledgeable persons having the technical skills necessary to evaluate their suitability for specific applications.**

---

Since Continental ContiTech, Inc. has no control over the number and variety of applications for which its products may be purchased or the conditions under which its products may be used by others, Continental ContiTech assumes no responsibility for performance results and applications. This catalog, however, contains available information to allow the user to determine the product's acceptability and fitness for specific applications. No statement contained herein shall be construed as a license to operate, or as a recommendation or inducement to infringe existing patents or as an endorsement of products of specific manufacturers or systems.

Failure to follow procedures for selection, installation, care, maintenance and storage of hoses may result in the hose's failure to perform properly and may result in damage to property and/or serious injury. Please refer to the General Information section of the catalog for hose care, maintenance and storage information.

All product design, dimensional and general information in this catalog is subject to change without prior notice. Working pressures and other technical information have been prepared from actual test results and other data considered to be reliable. However, Continental ContiTech assumes no responsibility for the accuracy of this information under varied conditions found in field use.

## Chemical Hose

Do not use chemical hose at temperatures or pressures above those recommended by the manufacturer. All operators must be thoroughly trained in the care and use of this hose and must, at all times, wear protective clothing. A hose or system failure could cause the release of poisonous, corrosive or flammable material.

Detailed information concerning storage, care and maintenance may be found in the Hose Handbook published by the Rubber Manufacturer's Association, 1400 K Street, N.W., Washington, D.C. 20005 and in SAE Recommended Practices J1273.

# Table of Contents

## Introduction

---

Application Warning	1
Index by Alphabet	3-5
Index by Application	6-8

## Continental ContiTech Industrial Hose

---

### Air & Multipurpose

General Purpose	9-25
Heavy Duty	26-33
Push-on	34-38

<b>Chemical Transfer</b>	<b>40-51</b>
<b>Cleaning Equipment</b>	<b>52-63</b>

### Food

Transfer	64-85
Washdown	86-93

<b>Marine</b>	<b>94-103</b>
---------------	---------------

### Material Handling

Abrasives	104-123
Bulk Transfer	124-133
Cement & Concrete	134-139

<b>Mining</b>	<b>140-149</b>
---------------	----------------

### Petroleum

Aircraft Fueling	150-156
Dispensing	157-170
Dock	171-185
Transfer	186-208

<b>Spray</b>	<b>209-211</b>
--------------	----------------

<b>Steam</b>	<b>212-220</b>
--------------	----------------

<b>Vacuum</b>	<b>221-226</b>
---------------	----------------

<b>Non-Branded</b>	<b>227-228</b>
--------------------	----------------

### Water

Discharge	229-239
Suction & Discharge	240-248
Washdown	249-253

<b>Welding</b>	<b>254-261</b>
----------------	----------------

<b>Coupling Systems</b>	<b>262-277</b>
-------------------------	----------------

<b>Equipment</b>	<b>278-289</b>
------------------	----------------

## Appendix

---

<b>Additional Products</b>	<b>290-292</b>
----------------------------	----------------

<b>Chemical Resistance Charts</b>	<b>293-313</b>
-----------------------------------	----------------

<b>Spiraflex Hose</b>	
-----------------------	--

<b>Chemical Resistance Guide</b>	<b>314-319</b>
----------------------------------	----------------

### General Information

Chemical Properties of FEP	320
Method for Steam Cleaning	320

Infinity/Paladin Drop Hose	
Coupling Procedure	321

Basic Hose Construction	322-323
-------------------------	---------

Hose End Definitions and	
Illustrations with Cutaways	324-325

Hose Testing Methods	326-327
----------------------	---------

Electrical Resistance Tests	328-331
-----------------------------	---------

Elastomers Used in	
Product Manufacturer	332-333

Selection of Proper Industrial Hose	334
-------------------------------------	-----

Industrial Hose Inquiry	335
-------------------------	-----

Useful Tables and Conversion Charts	336
-------------------------------------	-----

Length, Weight and Area Conversion Constants	338
--	-----

Properties of Saturated Steam	339
-------------------------------	-----

Flow Data	340-342
-----------	---------

Open-end Discharge	343
--------------------	-----

Fluid Velocity vs. Flow Rate	344
------------------------------	-----

RMA Oil and Gasoline Resistance Definition	345
--	-----

FDA Food Hose Compliance Information	346
--------------------------------------	-----

Precautions for Welding Hose Use/	
Background Information	347



<b>Minimum Run Requirements</b>	<b>348</b>
---------------------------------	------------

<b>Care, Maintenance and Storage</b>	<b>349-350</b>
--------------------------------------	----------------

# Industrial Hose Index By Alphabet

Name	Properties	Page #	Name	Properties	Page #
<b>A</b>			<b>A</b>		
Advantage		154	Fire Engine Booster		235
Aggie Gas		165	Flexdock 225		172
Allcrete Textile (plaster, grout & concrete)		136	Flexdock 300		173
Allcrete Wire		137	Flexible Downspout		115
Arctic ExtremeFlex		189	Flexshield SAE J1527 USCG Type A1-15 /		
Arctic Ortac		18	ISO 7840 Marine Barrier Hose		101
Arctic Ortac Plus		19	Flexsteel 250 CB Steam		216
Artrac		111	Flexsteel 250 Steam		214
Arvac SW		110	Flexsteel 250 EPDM-20		215
<b>B</b>			Flexsteel Futura	UL, CUL	158
BC Gasoline	UL, CUL	167	Flexsteel Futura Ethan-All		169
BC Marina	UL, CUL	168	Flexsteel Futura Low Perm	UL	160
Black Softwall		126	Flexsteel Futura HVR	UL	161
Blue Low Temp Fuel Oil Delivery		187	Flexsteel Service Station Air		21
Braidair		24	Flexsteel Futura Vapor Assist	UL	159
Brigade Mine	M	142	Flextra Dry Material		125
Brown Flexwing		46	Flextra Rock Dust	M	143
Blucor		108	Flexwing Oilfield		199
Blucor Couplings		109	Flexwing VersaFuel		190
Blue Fortress 300		90	Flexwing Water S&D		246
<b>C</b>			Fortress 300	A	87
Chem One	A	42	Fortress 1000	A	88
Cold Blue		242	Fortress 3000	A	89
Crimped Steam Assembly		218	Frontier™ 200		12-13
<b>D</b>			Frontier™ 250		12-13
Deadman Aircraft Refueling		155	Frontier™ 300		12-13
DEF Dispensing Hose		170	<b>G</b>		
DEF Transfer Hose		43	Galvanator 3000	A	63
Diversiflex		112	Gauntlet 1500	A	60
Diversipipe 75		113	Gauntlet 3000	A	61
Diversipipe 150		114	Gauntlet 4500	A	62
<b>E</b>			Twin-Line Welding (Grade R)		255
Yellow Air		29	Twin-Line Welding (Grade RM)	NC	256
Yellow Plus Air		30	Twin-Line Welding (Grade T)	NC	257
Exstatic	F	68	Gorilla	A, M, NC	11
<b>F</b>			Gray Flextra LT	F	67
F5		10	Green Hornet XF		243
Fabchem		45	Green XLPE		41
			<b>H</b>		
			Harvest	F	69
			Heavy Duty Steam Pile Driver		213
			Hi-Per		47
			Hot Tar & Asphalt Rough & Smooth Bore		181



**Properties Legend:**

 <b>A</b> - Superior Abrasion Resistance	 <b>M</b> - USMSHA Approved	 <b>NC</b> - Non-Conductive
 <b>F</b> - FDA, 3-A, & USDA Compliant	 <b>UL</b> - Underwriter's Laboratory Approved	 <b>CUL</b> - Underwriter's Laboratory Approved (Canada)

# Industrial Hose Index By Alphabet

Name	Properties	Page #	Name	Properties	Page #
<b>I</b>			<b>N</b>		
Infinity.....		191	Neptune 1500.....		54
Infinity HD.....		192	Neptune 3000.....		55
Infinity Stainless Steel & Aluminum Crimp Sleeves.....		276	Neptune 4001-R.....		56
Insta-Grip 250.....	A, NC	36	Neptune 4500.....		57
Insta-Grip 300.....	M, NC	35	Neptune 6000.....		58
Insta-Grip Plus.....	A, M, NC	38	NR Spray.....		210
Insta-Grip TC.....		37	Nutriflex Suction & Discharge.....	F	71
Insta-Lock Dust Cap.....		271	Nutriflex Static Wire.....	F	72
Insta-Lock Dust Plug.....		272	Nutriflo Suction & Discharge.....	F	70
Insta-Lock Fittings.....		269	<b>O</b>		
Insta-Lock Gaskets.....		274	Orange Flexwing.....		48
Insta-Lock Interlocking Ferrules.....		275	Ortac 250.....	A, NC	14-15
Insta-Lock Interlocking Stainless Steel NPT Male Hose Stem.....		270	Ortac 300.....	A, NC	14-15
Insta-Lock Repair Kits.....		273	Ortac 400.....	A, NC	14-15
Insta-Lock Type A Fitting.....		263	<b>P</b>		
Insta-Lock Type B Fitting.....		264	Pacer.....	UL, CUL	164
Insta-Lock Type C Fitting.....		265	Paladin.....		194
Insta-Lock Type D Fitting.....		266	Paladin Stainless Steel & Aluminum Crimp Sleeves.....		276
Insta-Lock Type E Fitting.....		267	Pathfinder Garden Hose.....		236
Insta-Lock Type F Fitting.....		268	PCG Placement Textile.....		138
<b>J</b>			Plicord 250 Steam.....		219
Jet Ranger.....		153	Plicord Air Green 400.....	NC	32
<b>L</b>			Plicord Ammonium Nitrate HD.....		146
LPG Delivery Pro.....		228	Plicord Ammonium Nitrate Pellet.....		145
LW Arctic Tank Truck.....		201	Plicord Arctic Flexwing.....		202
<b>M</b>			Plicord Auger Arc Piling.....		135
M&P Mine Conduit.....	M	144	Plicord Blast (2 ply & 4 ply).....		106
Marine Fuel Feed Vent USCG/SAE J1527 Type A2.....		102	Plicord Blue Flour.....	F	73
Marine Fuel Feed Vent USCG/SAE J1527 Type B2.....		103	Plicord Brewline.....	F	74
Marine Fuel Line USCG/SAE J1527 & ISO 7840 Type A1.....		100	Plicord Dredge Sleeve.....		117
Maxxim Premier.....	UL	162	Plicord ExtremeFlex Brown.....		50
Maxxim Premier Plus.....	UL	163	Plicord ExtremeFlex Food Grade.....		75
MIL A-A-59565.....		25	Plicord ExtremeFlex Petroleum.....	A	204
MIL-DTL-29210E Steam.....		220	Plicord ExtremeFlex Purple.....		51
Mine Spray.....	M	141	Plicord Flexwing Petroleum.....		193
			Plicord Fuel Discharge.....		203
			Plicord Furnace Door.....		237
			Plicord Gray Food.....	F	66
			Plicord Gunite (tan).....		139
			Plicord Hardwall Wet Exhaust.....		96-97
			Plicord HD Industrial Vacuum.....		225
			Plicord HD Water Discharge.....		238
			Plicord Hydovator.....		116

**Properties Legend:**

-  **A** - Superior Abrasion Resistance
-  **M** - USMSHA Approved
-  **NC** - Non-Conductive
-  **F** - FDA, 3-A, & USDA Compliant
-  **UL** - Underwriter's Laboratory Approved
-  **CUL** - Underwriter's Laboratory Approved (Canada)

# Industrial Hose Index By Alphabet

Name	Properties	Page #	Name	Properties	Page #
Plicord LW Black Flextra II		198	Spiraflex Black Lay-Flat Super Duty Hose		230
Plicord Mine Conduit	M	147	Spiraflex Blue (Extra Light Duty)		231
Plicord Oilfield Frac		197	Spiraflex Cable Guard	M	148
Plicord RVC		118	Spiraflex Ducting		223
Plicord SAE J1527 Type A2 (fuel fill)		95	Spiraflex Grassvac		222
Plicord Sand Suction		119	Spiraflex Gray (Light Duty)		232
Plicord Softwall Wet Exhaust		98-99	Spiraflex Mulch Blower		130
Plicord Super Black Flexwing		196	Spiraflex Polyurethane Vapor Recovery		205
Plicord Super Rock Drill	M	31	Spiraflex Red (Medium Duty)	M	233
Plicord Torridair Hot Air Blower		127	Spiraflex Rock Dust	M	149
Plicord Vacuum (HD & LW)		226	Spiraflex Vacuum		224
Plicord Versiflo 125		252	Spiraflex Yellow (Spiraflex 2700)	M	234
Plicord Washdown		251	SpiraFlow		53
Plicord Winline	F	76	Spirathane HD		121
Plicord XF Blast		107	Spirathane LD		1223
Pliovic Ag Spray (1800 & 2400)		211	Spirathane PT	F	122
Pliovic FG (FDA-3A)	F	77	Stainless Steel & Aluminum Crimp Sleeves		276
Pliovic GS	NC	22-23	Steel Air	M	27
Pliovic Plus 250	NC	22-23	Super Ortac	M	28
Potable Water	F	78	Super Sani-Wash 300		93
Pressure Washer Fittings		277	Sureline		250
Prospector Water Discharge 150		239			
Prospector Water S&D		248	<b>T</b>		
Pulp & Paper Washdown		252	Tan Flextra	F	83
Purple Flexwing		49	Tan Flexwing	F	82
Pyroflex II Hot Air		128	Tan Softwall	F	84
Pyroflex Hot Tar & Asphalt II		206	Tanker Barge Discharge		176
Pyroflex Hot Tar Wand		207			
			<b>V</b>		
<b>R</b>			Vapor Recovery Dock		177
Red Flextra 100		195	VariFlex 200	NC	17
Red Flextra 150		195	VariFlex 300	NC	17
Redwing Fuel Oil		188	Versiflo 150 Water S&D		247
Refueling Sensing		156	Vintner	F	79
			Viper	A	44
<b>S</b>			<b>W</b>		
Sandblast Deadman		105	White Flexwing	F	65
Sani-Wash 300		92	Whitewater		59
Service Station Air		21	Wingcraft		152
Single Line Welding (Grade R)		259			
Single Line Welding (Grade RM)	NC	260			
Single Line Welding (Grade T)		258			
Smooth Bore Dock 200		174			
Smooth Bore Dock 300		175			
Sani-Wash Plus 300		91			
Spiraflex 1600		244			
Spiraflex Aggie PVC		245			
Spiraflex Air Seeder Hose		120			







**Properties Legend:**

-  **A** - Superior Abrasion Resistance
-  **M** - USMSHA Approved
-  **NC** - Non-Conductive
-  **F** - FDA, 3-A, & USDA Compliant
-  **UL** - Underwriter's Laboratory Approved
-  **cUL** - Underwriter's Laboratory Approved (Canada)

# Industrial Hose Index By Application

Name	Properties	Page #	Name	Properties	Page #
<b>Air &amp; Multipurpose: General Purpose</b>			<b>Cleaning Equipment</b>		
Arctic Ortac		18	ContiTitan XP 300		87
Arctic Ortac Plus		19	ContiTitan XP 1000	A	88
Braidair		24	ContiTitan XP 3000	A	89
F5		22	Galvanator 3000	A	63
Flexsteel Service Station Air		10	Gauntlet 1500	A	60
Gorilla	A, M, NC	11	Gauntlet 3000	A	61
Frontier 200		13	Gauntlet 4500	A	62
Frontier 250		13	Neptune 1500		54
Frontier 300		13	Neptune 3000		55
MIL A-A-59565		25	Neptune 4001-R		56
Ortac 250	A, NC	15	Neptune 4500		57
Ortac 300	A, NC	15	Neptune 6000		58
Ortac 400	A, NC	15	SpiraFlow		55
Pliovic FG (FDA-3A)	F	23	Whitewater		59
Pliovic GS	NC	25			
Pliovic Plus 250	NC	25			
Pliovic PVC Tubing		23			
Service Station Air		21			
Variflex 200	NC	17			
Variflex 300	NC	17			
<b>Air &amp; Multipurpose: Heavy Duty</b>			<b>Food: Food Transfer</b>		
Yellow Air		29	Exstatic	F	68
Yellow Plus Air		30	Gray Flextra LT	F	67
Plicord Air Green 400	NC	32	Harvest	F	69
Plicord Super Rock Drill	M	31	Nutriflex Suction & Discharge	F	71
Steel Air	M	27	Nutriflex Static Wire	F	72
Super Ortac	M	28	Nutriflo Suction & Discharge	F	70
			Plicord Blue Flour	F	73
			Plicord Brewline	F	74
			Plicord ExtremeFlex Food Grade		75
			Plicord Gray Food	F	66
			Plicord Wineline	F	76
			Pliovic FG (FDA-3A)	F	77
			Potable Water	F	78
			Spirathane PT	F	121
			Vintner	F	79
			White Flexwing	F	65
<b>Air &amp; Multipurpose: Push-on</b>			<b>Food: Food Washdown</b>		
AutoGrip	A, M, NC	35	Blue ContiTitan XP 300		99
Insta-Grip 250	A, NC	36	ContiTitan XP 300	A	87
Insta-Grip 300	M, NC	35	ContiTitan XP 1000	A	89
Insta-Grip TC		37	ContiTitan XP 3000	A	88
Insta-Grip Plus	A, M, NC	38	Gauntlet 1500	A	60
			Plicord Washdown		242
			Sani-Wash 300		92
			Sani-Wash Plus 300		91
			Super Sani-Wash 300		93
<b>Chemical Transfer</b>			<b>Marine</b>		
Blue Flexwing		44	Flexshield Marine Barrier Hose SAE		
Brown Flexwing		46	J1527 USCG Type A1-15 / ISO 7840		101
Chem One	A	42	Marine Fuel Feed Vent Hose		
DEF Transfer Hose		43	USCG/SAE J1527 Type A2		102
Fabchem		45			
Green XLPE		44			
Hi-Per		48			
Orange Flexwing		48			
Plicord ExtremeFlex Brown		50			
Plicord ExtremeFlex Purple		51			
Purple Flexwing		49			
Viper	A	44			

**Properties Legend:**

 <b>A</b> - Superior Abrasion Resistance	 <b>M</b> - USMSHA Approved	 <b>NC</b> - Non-Conductive
 <b>F</b> - FDA, 3-A, & USDA Compliant	 <b>UL</b> - Underwriter's Laboratory Approved	 <b>CUL</b> - Underwriter's Laboratory Approved (Canada)

# Industrial Hose Index By Application

Name	Properties	Page #	Name	Properties	Page #
Marine Fuel Feed Vent Hose			Plicord Ammonium Nitrate HD.....		146
USCG/SAE J1527 Type B2 .....		103	Plicord Ammonium Nitrate Pellet.....		145
Marine Fuel Line			Plicord Mine Conduit .....	M	147
USCG/SAE J1527 & ISO 7840 Type A1.....		100	Spiraflex Cable Guard.....	M	148
Plicord Hardwall Wet Exhaust .....		96-97	Spiraflex Red Medium Duty .....	M	233
Plicord SAE J1527 Type A2 (fuel fill).....		95	Spiraflex Rock Dust .....	M	149
Plicord Softwall Wet Exhaust .....		98-99	Spiraflex Yellow (Spiraflex 2700) .....	M	234
			TunnelCote Rock Dust.....	M	146
<b>Material Handling: Abrasives</b>			<b>Petroleum: Aircraft Fueling</b>		
Artrac.....		111	Advantage .....		154
Arvac SW.....		110	Deadman Aircraft Refueling.....		155
Blucor .....		108	Jet Ranger .....		143
Blucor Couplings.....		109	Refueling Sensing.....		151
Diversiflex .....		112	Wingcraft.....		152
Diversipipe 75 .....		113			
Diversipipe 150.....		114	<b>Petroleum: Petroleum Dispensing</b>		
Flexible Downspout.....		115	Aggie Gas .....		165
Nutriflex Static Wire.....	F	72	BC Gasoline .....	UL, CUL	167
Plicord Blast (2 ply & 4 ply).....		106	BC Marina .....	UL, CUL	168
Plicord Dredge Sleeve.....		117	DEF Dispensing Hose.....		170
Plicord Hydrovator.....		116	Flexsteel Futura Ethan-All.....		169
Plicord RVC .....		118	Flexsteel Futura .....	UL, CUL	158
Plicord Sand Suction.....		119	Flexsteel Futura Low Perm .....	UL, CUL NEW	160
Plicord XF Blast (2 ply & 4 ply).....		107	Flexsteel Futura HVR .....	UL, CUL NEW	161
Sandblast Deadman .....		105	Flexsteel Futura Vapor Assist.....	UL	159
Spiraflex Air Seeder Hose.....		120	Maxxim Premier .....	UL	162
Spirathane HD .....		121	Maxxim Premier Plus.....	UL	163
Spirathane LD.....		123	Pacer.....	UL, CUL	164
Spirathane PT.....	F	122			
			<b>Petroleum: Petroleum Dock Hose</b>		
<b>Material Handling: Bulk Transfer</b>			Flexdock 225 .....		172
Black Softwall .....		126	Flexdock 300.....		173
Flextra Dry Material.....		125	Hot Tar & Asphalt Rough & Smooth Bore.....		181
Plicord Torridair Hot Air Blower.....		127	Smooth Bore Dock 200.....		174
Pyroflex II Hot Air .....		128	Smooth Bore Dock 300.....		175
Spiraflex Mulch Blower .....		130	Tanker Barge Discharge .....		176
Tan Flextra .....	F	132	Vapor Recovery Dock.....		177
Tan Flexwing.....	F	131			
Tan Softwall .....	F	133	<b>Petroleum: Petroleum Transfer</b>		
			Arctic ExtremeFlex.....		189
<b>Material Handling: Cement &amp; Concrete</b>			Flexwing Oilfield .....		189
Allcrete Textile (plaster, grout & concrete).....		136	Flexwing VersaFuel .....		190
Allcrete Wire.....		137	Infinity.....		191
PGC Placement Textile.....		138	Infinity HD.....		192
Plicord Auger Arc Piling.....		135	LW Arctic Tank Truck.....		201
Plicord Gunite (tan) .....		139	Paladin .....		194
			Plicord Arctic Flexwing .....		202
<b>Mining</b>			Plicord ExtremeFlex Petroleum.....	A	204
Brigade Mine.....	M	142	Plicord Flexwing Petroleum .....		193
Flextra Rock Dust.....	M	143	Plicord Fuel Discharge.....		203
M&P Mine Conduit.....	M	144	Plicord LW Black Flextra II.....		198
Mine Spray.....	M	141			







**Properties Legend:**

 <b>A</b> - Superior Abrasion Resistance	 <b>M</b> - USMSHA Approved	 <b>NC</b> - Non-Conductive
 <b>F</b> - FDA, 3-A, & USDA Compliant	 <b>UL</b> - Underwriter's Laboratory Approved	 <b>CUL</b> - Underwriter's Laboratory Approved (Canada)

# Industrial Hose Index By Application

Name	Properties	Page #	Name	Properties	Page #
Plicord Oilfield Frac		197	<b>Water: Suction &amp; Discharge Hose</b>		
Plicord Super Black Flexwing		196	Cold Blue		242
Plicord Waste Mate		192	Green Hornet XF		243
Pyroflex Hot Tar & Asphalt II		206	Spiraflex 1600		244
Pyroflex Hot Tar Wand		207	Spiraflex Aggie PVC		245
Red Flextra 100		195	Versiflo 150 Water S&D		247
Red Flextra 150		195	<b>Water: Washdown Hose</b>		
Redwing Fuel Oil		188	Fortress 300	A	84
Spiraflex Polyurethane Vapor Recovery		205	Fortress 1000	A	88
<b>Spray Hose</b>			Fortress 3000	A	89
Mine Spray	M	141	Gauntlet 1500	A	67
NR Spray		210	Plicord Washdown		251
Pliovic Ag Spray (1800 & 2400)		211	Pulp & Paper Washdown		252
<b>Steam Hose</b>			Sani-Wash 300		92
Crimped Steam Assembly		218	Sani-Wash Plus 300		91
Flexsteel 250 CB Steam		216	Super Sani-Wash 300		93
Flexsteel 250 Steam		214	Sureline		250
Flexsteel 250 EPDM-20		215	<b>Welding Hoses</b>		
Heavy Duty Steam Pile Driver		213	Twin-Line Welding (Grade R)		255
MIL-DTL-29210E		220	Twin-Line Welding (Grade RM)	NC	256
Plicord 250 Steam		219	Twin-Line Welding (Grade T)	NC	257
<b>Vacuum Hose</b>			Single Line Welding (Grade R)		259
Arvac SW		110	Single Line Welding (Grade RM)		260
Plicord HD Industrial Vacuum		225	Single Line Welding (Grade T)		258
Plicord Vacuum (HD & LW)		217	<b>Coupling Systems</b>		
Spiraflex Ducting		223	Infinity Stainless Steel &		
Spiraflex Grassvac		222	Aluminum Crimp Sleeves		266
Spiraflex Vacuum		224	Insta-Lock Dust Cap		271
Spirathane HD		121	Insta-Lock Dust Plug		272
Spirathane LD		123	Insta-Lock Fittings		269
Spirathane PT	F	122	Insta-Lock Gaskets		274
<b>Continental ContiTech</b>			Insta-Lock Interlocking Ferrules		275
LPG Delivery Pro	UL	227	Insta-Lock Interlocking Stainless		
<b>Water: Discharge Hose</b>			Steel Male NPT Hose Stem		270
Brigade Mine	M	142	Insta-Lock Repair Kits		273
Fire Engine Booster		234	Insta-Lock Type A Fitting		263
Pathfinder Garden Hose		236	Insta-Lock Type B Fitting		264
Plicord Furnace Door		237	Insta-Lock Type C Fitting		265
Plicord HD Water Discharge		238	Insta-Lock Type D Fitting		266
Plicord Versiflo 125		252	Insta-Lock Type E Fitting		267
Plicord Water Discharge 150		232	Insta-Lock Type F Fitting		268
Potable Water	F	78	Paladin Stainless Steel &		
Spiraflex Black (Lay-Flat Super Duty Hose)		230	Aluminum Crimp Sleeves		276
Spiraflex Blue (Extra Light Duty)		231	Pressure Washer Fittings		277
Spiraflex Gray (Light Duty)		232			
Spiraflex Red (Medium Duty)	M	233			
Spiraflex Yellow (Heavy Duty)	M	234			

**Properties Legend:**

-  **A** - Superior Abrasion Resistance
-  **M** - USMSHA Approved
-  **NC** - Non-Conductive
-  **F** - FDA, 3-A, & USDA Compliant
-  **UL** - Underwriter's Laboratory Approved
-  **CUL** - Underwriter's Laboratory Approved (Canada)



# General Purpose



	Page	Superior Abrasion over	MSHA	Non-conductive	Oil Resistance Tube*	Oil Resistance Cover*	Temp. Range	Thermo-plastic	Rubber
Arctic Ortac	18				A	A	-65°F to 180°F (-54°C to 82°C)		Yes
Arctic Ortac Plus	19				A	A	-65°F to 180°F (-54°C to 82°C)		Yes
Braidair	24				A	B	-20°F to 190°F (-29°C to 88°C)		Yes
F5	10				B	B	-40°F to 158°F (-40°C to 70°C)	Yes	
Flexsteel Service Station Air	20				B	B	-20°F to 190°F (-29°C to 88°C)		Yes
Gorilla	11	Yes	Yes	Yes	A	A	-20°F to 190°F (-29°C to 88°C)		Yes
Frontier 200	12-13				C	C	-40°F to 190°F (-40°C to 88°C)		Yes
Frontier 250	12-13				C	C	-40°F to 190°F (-40°C to 88°C)		Yes
Frontier 300	12-13				C	C	-40°F to 190°F (-40°C to 88°C)		Yes
Mil A-A-59565 Military Air Hose	25				C	C	-40°F to 190°F (-40°C to 88°C)		
Ortac 250	14-15	Yes		Yes	A	A	-20°F to 190°F (-29°C to 88°C)		Yes
Ortac 300	14-15	Yes		Yes	A	A	-20°F to 190°F (-29°C to 88°C)		Yes
Ortac 400	14-15	Yes	Yellow Only	Yes	A	A	-20°F to 190°F (-29°C to 88°C)		Yes
Pliovic FG (FDA-3A)	77			Yes	B	B	-10°F to 158°F (-40°C to 70°C)	Yes	
Pliovic GS	22-23			Yes	B	B	-10°F to 158°F (-40°C to 70°C)	Yes	
Pliovic Plus 250	22-23			Yes	B	B	-10°F to 158°F (-40°C to 70°C)	Yes	
Service Station Air	21				C	C	-40°F to 190°F (-40°C to 88°C)		Yes
VariFlex 200	16-17			Yes	A	B	-20°F to 190°F (-29°C to 88°C)		Yes
VariFlex 300	16-17			Yes	A	B	-20°F to 190°F (-29°C to 88°C)		Yes

\*Based on RMA oil classification. For more information, see Appendix C.

**Air & Multipurpose**  
General Purpose  
Heavy Duty  
Push-on

Chemical Transfer

Cleaning Equipment

**Food**  
Transfer  
Washdown

Marine

**Material Handling**  
Abrasives  
Bulk Transfer  
Cement & Concrete

Mining

**Petroleum**  
Aircraft Fueling  
Dispensing  
Dock  
Transfer

Spray

Steam

Vacuum

Continental ContiTech

**Water**  
Discharge  
Suction & Discharge  
Washdown

Welding

Coupling Systems

Equipment

Appendix

# F5™ Air Hose



**Air & Multipurpose**  
General Purpose  
Heavy Duty  
Push-on

Chemical Transfer

Cleaning Equipment

**Food**  
Transfer  
Washdown

Marine

**Material Handling**  
Abrasives  
Bulk Transfer  
Cement & Concrete

Mining

**Petroleum**  
Aircraft Fueling  
Dispensing  
Dock  
Transfer

Spray

Steam

Vacuum

Continental ContiTech

**Water**  
Discharge  
Suction & Discharge  
Washdown

Welding

Coupling Systems

Equipment

Appendix

## Product Specifications

### Application

A hybrid thermoplastic hose that provides durability and flexibility, is lightweight and has a low drag resistance. F5™ is non-marking, oil resistant and performs well under cold temperatures to -40°F (-40°C). This 300 psi hose is designed for a variety of pneumatic applications in industries such as construction and manufacturing.

### Construction Tube

Blue Flexible TPE, RMA Class B (Medium Oil Resistance)

### Cover

Matte Blue Flexible TPE, RMA Class B (Medium Oil Resistance)

### Reinforcement

Polyester yarn

### Temperature Range

-40°F to 158°F (-40°C to 70°C)

### Packaging

25', 50', 100' coils or 750' reels

### Branding

Example: F5™ 300 psi. Made in U.S.A. Continental ContiTech

### Couplings

MxM NPT for coupled assemblies

### Order Codes

540-438 (blue)

## F5™ Air Hose

SAP #	ID		Nom. OD		Max. WP		Weight	
	in.	mm	in.	mm	psi	MPa	lb./ft.	kg/m
20463343	1/4	6.6	.50	11.5	300	2.07	0.06	0.09
20476820	5/16	7.9	.59	15.0	300	2.07	0.09	0.15
20463342	3/8	9.8	.64	16.2	300	2.07	0.10	0.16
20463341	1/2	12.7	.81	20.0	300	2.07	0.16	0.24
20470081	3/4	18.9	1.11	28.1	300	2.07	0.26	0.36
20476821	1	25.4	1.37	34.8	200	1.38	0.35	0.52

# Gorilla®



**Air & Multipurpose**  
General Purpose  
Heavy Duty  
Push-on

## Product Specifications

### Application

A premium-quality, multipurpose industrial hose with a wide range of applications in factories, construction, agriculture, quarries, mines, railroads, the oil and gas industry, and shipbuilding. All sizes are rated at 500 psi (3.4 MPa) maximum working pressure. Non-conductive, minimum electrical resistance greater than one (1) megaohm per inch of hose length at 1000 Volts DC.

3/16" - 3/4" - 500' reels, maximum 3 pieces, 50' increments  
 1" - 450' reels, maximum 3 pieces, 50' increments  
 1¼" - 250'-400' reels, maximum 3 pieces, 50' increments  
 1½" - 150'-300' reels, maximum 3 pieces, 50' increments  
 2" - 200' carton, maximum 3 pieces, 50' increments  
 Coupled assemblies available: 1/4", 3/8", 1/2", and 3/4".

### Construction Tube

Nitrile synthetic rubber, RMA Class A (High Oil Resistance)

### Branding

Example: Gorilla® 1" (25.4 mm) 500 psi. Made in U.S.A. Continental ContiTech. Flame Resistant USMSHA No. 2G-14C/14

### Cover

Yellow Carbryn™ synthetic rubber, RMA Class A (High Oil Resistance) MSHA approved

### Couplings

Contact fitting manufacturer for proper fitting recommendation and coupling procedure.

### Reinforcement

Spiral aramid yarn, 2" is braided synthetic yarn

### Order Codes

569-035  
 536-446 (2")

### Temperature Range

-20°F to 190°F (-29°C to 88°C)

### Packaging

90% one piece reels up to 1 inch

SAP #	ID		Nom OD		Max. WP		Weight	
	in.	mm	in.	mm	psi	MPa	lb./ft.	kg/m
20026239	1/4	6.4	0.61	15.5	500	3.45	0.17	0.25
20026255	5/16	7.9	0.69	17.5	500	3.45	0.20	0.30
20026256	3/8	9.5	0.73	18.6	500	3.45	0.22	0.33
20026273	1/2	12.7	0.89	22.6	500	3.45	0.28	0.42
20026289	5/8	15.9	1.06	26.9	500	3.45	0.35	0.52
20026290	3/4	19.1	1.19	30.2	500	3.45	0.41	0.61
20026304	1	25.4	1.50	37.8	500	3.45	0.58	0.86
20026306	1¼	31.8	1.77	45.6	500	3.45	0.79	1.18
20026309	1½	38.1	2.04	51.8	500	3.45	0.86	1.27
20023183	2	50.8	2.62	66.6	500	3.45	1.22	1.82

Chemical Transfer

Cleaning Equipment

**Food**  
Transfer  
Washdown

Marine

**Material Handling**  
Abrasives  
Bulk Transfer  
Cement & Concrete

Mining

**Petroleum**  
Aircraft Fueling  
Dispensing  
Dock  
Transfer

Spray

Steam

Vacuum

Continental ContiTech

**Water**  
Discharge  
Suction & Discharge  
Washdown

Welding

Coupling Systems

Equipment

Appendix

# Frontier



## Product Specifications

### Application

An economical air and water hose, Frontier is for a wide range of industrial, construction and agricultural applications. Available in 200, 250, and 300 psi working pressures.

1¼" - 400' reels, maximum 3 pieces, 50' increments  
 1½" - 300' reels, maximum 3 pieces, 50' increments  
 2" - 200' cartons, maximum 3 pieces, 50' increments  
 Coupled assemblies available in 1/4", 3/8", 1/2", and 3/4" in red.

### Construction Tube

EPDM synthetic rubber, RMA Class C (Limited Oil Resistance)

### Branding

Example: 1/2" Frontier Continental ContiTech 300 psi WP

### Cover

Black, Red, Yellow, Green or Blue EPDM synthetic rubber Class C (Limited Oil)

### Couplings

Contact fitting manufacturer for proper fitting recommendation and coupling procedure.

### Reinforcement

Spiral synthetic yarn, 2" is braided

### Order Codes

See next page

### Temperature Range

-40°F to 190°F (-40°C to 88°C)

### Packaging

90% one piece reels up to 1 inch  
 3/16"-3/4" - 500' reels, maximum 3 pieces, 50' increments  
 1" - 450' reels, maximum 3 pieces, 50' increments

---

EPDM is a registered trademark of Continental ContiTech.

**Air & Multipurpose**  
 General Purpose  
 Heavy Duty  
 Push-on

Chemical Transfer

Cleaning Equipment

**Food**  
 Transfer  
 Washdown

Marine

**Material Handling**  
 Abrasives  
 Bulk Transfer  
 Cement & Concrete

Mining

**Petroleum**  
 Aircraft Fueling  
 Dispensing  
 Dock  
 Transfer

Spray

Steam

Vacuum

Continental ContiTech

**Water**  
 Discharge  
 Suction & Discharge  
 Washdown

Welding

Coupling Systems

Equipment

Appendix

**Frontier 200**

Order Codes: 536-035 (2" black), 536-040 (2" red), 569-009 (black), 569-011 (red), 569-038 (yellow), 569-547 (blue)

SAP #				ID		Nom. OD		Max. WP		Weight	
Black	Red	Blue	Yellow	in.	mm	in.	mm	psi	MPa	lb./ft.	kg/m
20025544	20025733		20709043	3/16	4.8	0.44	11.2	200	1.38	0.08	0.12
20025553	20025735	20026919	20654587	1/4	6.4	0.50	12.7	200	1.38	0.09	0.13
20025565	20025748	20026920		5/16	7.9	0.58	14.7	200	1.38	0.12	0.18
20025572	20025750	20338093	20026337	3/8	9.5	0.67	17.0	200	1.38	0.15	0.22
20025591	20025773	20026921	20026353	1/2	12.7	0.81	20.6	200	1.38	0.20	0.30
20025610	20025787	20026923		5/8	15.9	0.97	24.6	200	1.38	0.27	0.40
20025619	20025799	20026925	20026358	3/4	19.1	1.12	28.5	200	1.38	0.34	0.51
20025641		20026928	20026361	1	25.4	1.44	36.8	200	1.38	0.54	0.80
20025649	20025826	20736320	20026364	1¼	31.8	1.73	44.0	200	1.38	0.75	1.12
20025655	20025834	20340494	20026366	1½	38.1	1.98	50.3	200	1.38	0.86	1.28
20022897	20022939			2	50.8	2.50	63.5	200	1.38	1.16	1.73

**Frontier 250**

Order Codes: 569-010 (black), 569-012 (red), 569-039 (yellow), 569-506 (green), 569-548 (blue)

SAP #					ID		Nom. OD		Max. WP		Weight	
Black	Red	Yellow	Green	Blue	in.	mm	in.	mm	psi	MPa	lb./ft.	kg/m
20025667	20025844	20026368	20742873	20742876	1/4	6.4	0.53	13.5	250	1.72	0.11	0.16
20025670	20025865				5/16	7.9	0.59	15.0	250	1.72	0.13	0.19
20025674	20025869	20026374	20742874	20617089	3/8	9.5	0.70	17.8	250	1.72	0.17	0.25
20025685	20025899	20026375	20026807	20617190	1/2	12.7	0.84	21.3	250	1.72	0.22	0.33
20025695	20025922	20026376			5/8	15.9	0.98	24.9	250	1.72	0.27	0.40
20025701	20025932	20026379	20026809	20026929	3/4	19.1	1.14	29.0	250	1.72	0.35	0.52

**Frontier 300**

Order Codes: 569-516 (yellow), 569-557 (red), 569-560 (green)

SAP #			ID		Nom. OD		Max. WP		Weight	
Red	Yellow	Green	in.	mm	in.	mm	psi	MPa	lb./ft.	kg/m
20026960			1/4	6.4	0.53	13.5	300	2.07	0.10	0.15
20026971	20127382	20761181	3/8	9.5	0.70	17.8	300	2.07	0.17	0.25
20026980	20127385	20761182	1/2	12.7	0.84	21.3	300	2.07	0.22	0.33
20026985	20026845	20048519	3/4	19.1	1.15	29.2	300	2.07	0.37	0.55
20026992	20026859	20048546	1	25.4	1.48	37.3	300	2.07	0.58	0.86

**Air & Multipurpose**  
General Purpose  
Heavy Duty  
Push-on

Chemical Transfer

Cleaning Equipment

**Food**  
Transfer  
Washdown

Marine

**Material Handling**  
Abrasives  
Bulk Transfer  
Cement & Concrete

Mining

**Petroleum**  
Aircraft Fueling  
Dispensing  
Dock  
Transfer

Spray

Steam

Vacuum

Continental ContiTech

**Water**  
Discharge  
Suction & Discharge  
Washdown

Welding

Coupling Systems

Equipment

Appendix

# Ortac®



## Product Specifications

### Application

Ortac® (Oil Resistant Tube and Cover) is our most popular premium-quality multipurpose hose. Used in the most abusive industrial applications, Ortac® will handle air, oil, water, kerosene and some chemicals. Non-conductive, minimum electrical resistance greater than one (1) megohm per inch of hose length; at 1000 volts DC. Available in 250, 300 and 400 psi working pressures. Note: Ortac® 400 Yellow is USMSHA approved.

### Construction Tube

Nitrile synthetic rubber, RMA Class A (High Oil Resistance)

### Cover

Red or Yellow Carbryn™ synthetic rubber, RMA Class A (High Oil Resistance)

### Reinforcement

Spiral synthetic yarn, 2" is braided

### Temperature Range

-20°F to 190°F (-29°C to 88°C)

### Packaging

90% one piece reels up to 1 inch  
 3/16"-3/4" - 500' reels, maximum 3 pieces, 50' increments  
 1" - 450' reels, maximum 3 pieces, 50' increments  
 1¼" - 400' reels, maximum 3 pieces, 50' increments  
 1½" - 300' reels, maximum 3 pieces, 50' increments  
 2" - 200'; cartons, maximum 3 pieces, 50' increments

### Branding

Example: 1½" (38.1mm) Ortac® 300 psi WP. Made in U.S.A. Continental ContiTech

### Couplings

Contact fitting manufacturer for proper fitting recommendation and coupling procedure.

### Order Codes

See next page

Air & Multipurpose  
 General Purpose  
 Heavy Duty  
 Push-on

Chemical Transfer

Cleaning Equipment

Food  
 Transfer  
 Washdown

Marine

Material Handling  
 Abrasives  
 Bulk Transfer  
 Cement & Concrete

Mining

Petroleum  
 Aircraft Fueling  
 Dispensing  
 Dock  
 Transfer

Spray

Steam

Vacuum

Continental ContiTech

Water  
 Discharge  
 Suction & Discharge  
 Washdown

Welding

Coupling Systems

Equipment

Appendix

**Ortac® 250**

Order Codes: 569-058 (1/4"-1/2" red), 536-465 (2" red), 536-010 (2" black)

SAP #	ID		Nom. OD		Max. WP		Weight		
	Red	in.	mm	in.	mm	psi	MPa	lb./ft.	kg/m
20026527	1/4		6.4	0.53	13.5	250	1.72	0.09	0.13
20026529	5/16		7.9	0.62	17.5	250	1.72	0.14	0.21
20026531	3/8		9.5	0.69	17.5	250	1.72	0.15	0.22
20026534	1/2		12.7	0.84	21.3	250	1.72	0.20	0.30
20026538	5/8		15.9	1.00	25.4	250	1.72	0.26	0.39
20026540	3/4		19.1	1.14	29.0	250	1.72	0.34	0.51
20026544	1		25.4	1.47	37.3	250	1.72	0.51	0.76
20023278	2		50.8	2.50	63.5	200	1.37	1.08	1.61

**Ortac® 300**

Order Codes: 569-059 (red)

SAP #	ID		Nom. OD		Max. WP		Weight		
	Red	in.	mm	in.	mm	psi	MPa	lb./ft.	kg/m
20026560	3/16		4.8	0.44	11.8	300	2.07	0.07	0.10
20026561	1/4		6.4	0.61	15.7	300	2.07	0.14	0.21
20026563	5/16		7.9	0.68	17.3	300	2.07	0.16	0.24
20026564	3/8		9.5	0.73	18.6	300	2.07	0.18	0.27
20026568	1/2		12.7	0.89	22.6	300	2.07	0.25	0.37
20026570	5/8		15.9	1.06	26.9	300	2.07	0.35	0.52
20026571	3/4		19.1	1.19	30.2	300	2.07	0.40	0.60
20026575	1		25.4	1.50	38.1	300	2.07	0.59	0.88
20026579	1¼		31.8	1.81	46.0	300	2.07	0.76	1.13
20026583	1½		38.1	2.08	52.8	300	2.07	0.88	1.31

**Ortac® 400**

Order Codes: 569-065 (yellow), (USMSHA rated), 569-066 (red)

SAP #	ID		Nom. OD		Max. WP		Weight		
	Yellow	in.	mm	in.	mm	psi	MPa	lb./ft.	kg/m
20026596	1/4		6.4	0.61	15.7	400	2.76	0.16	0.24
20026598	3/8		9.5	0.73	18.8	400	2.76	0.20	0.30
20026599	1/2		12.7	0.89	22.8	400	2.76	0.26	0.39
20026600	3/4		19.1	1.18	30.0	400	2.76	0.41	0.61
20026601	1		25.4	1.50	38.1	400	2.76	0.61	0.91

**Air & Multipurpose**  
General Purpose  
Heavy Duty  
Push-on

Chemical Transfer

Cleaning Equipment

**Food**  
Transfer  
Washdown

Marine

**Material Handling**  
Abrasives  
Bulk Transfer  
Cement & Concrete

Mining

**Petroleum**  
Aircraft Fueling  
Dispensing  
Dock  
Transfer

Spray

Steam

Vacuum

Continental ContiTech

**Water**  
Discharge  
Suction & Discharge  
Washdown

Welding

Coupling Systems

Equipment

Appendix

# VariFlex™



## Product Specifications

### Application

A good-quality, economical general purpose hose for industrial air service, compressor lines, pneumatic tools, low-pressure spray and many other applications where the need for oil resistance is moderate. Non-conductive, minimum electrical resistance greater than one (1) megohm per inch of length of hose at 1000 volts DC. Available in 200 and 300 psi working pressures.

### Construction Tube

Nitrile synthetic rubber, RMA Class A (High Oil Resistance)

### Cover

Red, Blue or Black Chemivic™ synthetic rubber, RMA Class A (High Oil Resistance)

### Reinforcement

Spiral synthetic yarn (3/16"-1½"), braided synthetic yarn (2")

### Temperature Range

-20°F to 190°F (-29°C to 88°C)

### Packaging

90% one piece reels up to 1 inch  
 3/16"-3/4" - 500' reels, maximum 3 pieces, 50' increments  
 1" - 450' reels, maximum 3 pieces, 50' increments  
 1¼" - 400' reels, maximum 3 pieces, 50' increments  
 1½" - 300' reels, maximum 3 pieces, 50' increments  
 Coupled assemblies available in 1/4", 3/8" and 1/2" in red.

### Branding

Example: VariFlex™ non-conductive 1/2" (12.7mm) 200 psi WP. Made in U.S.A. Continental ContiTech

### Couplings

Contact fitting manufacturer for proper fitting recommendation and coupling procedure.

### Order Codes

See below.

Air & Multipurpose  
 General Purpose  
 Heavy Duty  
 Push-on

Chemical Transfer

Cleaning Equipment

Food  
 Transfer  
 Washdown

Marine

Material Handling  
 Abrasives  
 Bulk Transfer  
 Cement & Concrete

Mining

Petroleum  
 Aircraft Fueling  
 Dispensing  
 Dock  
 Transfer

Spray

Steam

Vacuum

Continental ContiTech

Water  
 Discharge  
 Suction & Discharge  
 Washdown

Welding

Coupling Systems

Equipment

Appendix



**VariFlex™ 200**

Order Codes: 569-005 (black), 569-007 (red), 569-036 (blue)

SAP #			ID		Nom. OD		Max. WP		Weight	
Black	Red	Blue	in.	mm	in.	mm	psi	MPa	lb./ft.	kg/m
20666346			3/16	4.8	0.44	11.2	200	1.38	0.07	0.10
20025396	20025484		1/4	6.4	0.53	13.5	200	1.38	0.10	0.15
20025397	20025485		5/16	7.9	0.63	16.0	200	1.38	0.14	0.21
20025399	20025487		3/8	9.5	0.69	17.5	200	1.38	0.15	0.22
20025402	20025490	20147654	1/2	12.7	0.84	21.3	200	1.38	0.21	0.31
20025403	20025492	20612705	5/8	15.9	1.00	25.4	200	1.38	0.27	0.40
20025404	20025493	20026313	3/4	19.1	1.13	28.7	200	1.38	0.38	0.57
20025405	20025495		1	25.4	1.47	37.3	200	1.38	0.58	0.86

**VariFlex™ 300**

Order Codes: 569-006 (black), 569-008 (3/16"-1½" red), 569-037 (blue), 536-037 (2" red)

SAP #			ID		Nom. OD		Max. WP		Weight	
Black	Red	Blue	in.	mm	in.	mm	psi	MPa	lb./ft.	kg/m
20025408		20025498	1/4	6.4	0.54	13.7	300	2.07	0.14	0.21
20025428		20025499	5/16	7.9	0.64	16.3	300	2.07	0.18	0.27
20025430	20026318	20025502	3/8	9.5	0.69	17.5	300	2.07	0.19	0.28
20025450	20026319	20025512	1/2	12.7	0.86	21.8	300	2.07	0.26	0.39
20333327	20026322	20025518	5/8	15.9	1.02	25.9	300	2.07	0.33	0.49
20025471	20026323	20025522	3/4	19.1	1.19	30.2	300	2.07	0.42	0.63
20025477	20026334	20025532	1	25.4	1.50	38.1	300	2.07	0.62	0.92
20026192		20022900	1¼	31.8	1.77	45.6	250	1.72	0.84	1.25
20026194		20022906	1½	38.1	2.08	53.2	250	1.72	1.01	1.50
20530997		20585903	2	50.8	2.50	63.5	300	2.07	1.02	1.52

**Air & Multipurpose**  
General Purpose  
Heavy Duty  
Push-on

Chemical Transfer

Cleaning Equipment

**Food**  
Transfer  
Washdown

Marine

**Material Handling**  
Abrasives  
Bulk Transfer  
Cement & Concrete

Mining

**Petroleum**  
Aircraft Fueling  
Dispensing  
Dock  
Transfer

Spray

Steam

Vacuum

Continental ContiTech

**Water**  
Discharge  
Suction & Discharge  
Washdown

Welding

Coupling Systems

Equipment

Appendix

# Arctic Ortac®



**Air & Multipurpose**  
General Purpose  
Heavy Duty  
Push-on

Chemical Transfer

Cleaning Equipment

**Food**  
Transfer  
Washdown

Marine

**Material Handling**  
Abrasives  
Bulk Transfer  
Cement & Concrete

Mining

**Petroleum**  
Aircraft Fueling  
Dispensing  
Dock  
Transfer

Spray

Steam

Vacuum

Continental ContiTech

**Water**  
Discharge  
Suction & Discharge  
Washdown

Welding

Coupling Systems

Equipment

Appendix

## Product Specifications

### Application

Arctic Ortac® (Oil Resistant Tube and Cover) is our most popular cold temperature multipurpose hose. For use with air, water, oil, kerosene, fuel oil and some chemical applications.

### Construction Tube

Nitrile synthetic rubber, RMA Class A (High Oil Resistance)

### Cover

Neoprene, RMA Class B (High Oil Resistance)

### Reinforcement

One textile braid

### Temperature Range

-65°F to 180°F (-54°C to 82°C)

### Packaging

500' reels, maximum 3 pieces, 50' minimum length

### Branding

Example: 9.5mm 3/8" Arctic Ortac® Continental ContiTech 2.1 MPa/300 psi. Made In U.S.A.

### Couplings

Contact fitting manufacturer for proper fitting recommendation and coupling procedure.

### Order Codes

536-276

## Arctic Ortac®

SAP #	ID		Nom. OD		Max. WP		Weight	
	in.	mm	in.	mm	psi	MPa	lb./ft.	kg/m
20116761	1/4	6.4	0.63	16.0	300	2.07	0.14	0.21
20116614	3/8	9.5	0.75	19.1	300	2.07	0.19	0.28
20116762	1/2	12.7	0.91	23.1	300	2.07	0.25	0.37
20116615	3/4	19.1	1.18	30.0	300	2.07	0.36	0.54
20116763	1	25.4	1.50	38.1	300	2.07	0.58	0.86
20116617	1¼	31.8	1.80	45.7	300	2.07	0.74	1.10
20125302	1¾	34.9	1.97	50.0	300	2.07	0.92	1.37
20116618	1½	38.1	2.09	53.1	300	2.07	1.01	1.50

# Arctic Ortac® Plus



## Product Specifications

### Application

A low-temperature hose construction for air, water, oil, kerosene, fuel oil and some chemical operations where temperatures fall as low as -65°F (-54°C).

### Construction Tube

Black low-temp, ECO oil-resistant synthetic rubber, RMA Class A (High Oil Resistance)

### Cover

Black ultra-low temperature, ECO oil resistant synthetic rubber (with a blue stripe), RMA Class A (High Oil Resistance)

### Reinforcement

One textile braid

### Temperature Range

-65°F to 180°F (-54°C to 82°C)

### Packaging

500' reels, maximum 3 pieces, 50' minimum length

### Branding

Example: 9.5mm 3/8" Arctic Ortac® Plus 2.1 MPa/300 psi. Continental ContiTech. Made In U.S.A.

### Couplings

Contact fitting manufacturer for proper fitting recommendation and coupling procedure.

### Order Codes

536-275

## Arctic Ortac® Plus

SAP #	ID		Nom. OD		Max. WP		Weight	
	in.	mm	in.	mm	psi	MPa	lb./ft.	kg/m
20159301	1/4	6.4	0.63	16.0	300	2.07	0.16	0.22
20159302	3/8	9.5	0.75	19.1	300	2.07	0.20	0.28
20159303	1/2	12.7	0.91	23.1	300	2.07	0.27	0.37
20159304	3/4	19.1	1.18	30.0	300	2.07	0.40	0.54
20146766	1	25.4	1.50	38.1	300	2.07	0.57	0.86

Air & Multipurpose  
General Purpose  
Heavy Duty  
Push-on

Chemical Transfer

Cleaning Equipment

Food  
Transfer  
Washdown

Marine

Material Handling  
Abrasives  
Bulk Transfer  
Cement & Concrete

Mining

Petroleum  
Aircraft Fueling  
Dispensing  
Dock  
Transfer

Spray

Steam

Vacuum

Continental ContiTech

Water  
Discharge  
Suction & Discharge  
Washdown

Welding

Coupling Systems

Equipment

Appendix

# Flexsteel® Service Station Air



## Product Specifications

### Application

For tire inflation service from towers, reels or curb connections.

### Construction Tube

Nitrile synthetic rubber, RMA Class B (Medium/High Oil Resistance)

### Cover

Red or Black nitrile synthetic rubber, abrasion- and oil-resistant, RMA Class B (Medium/High Oil Resistance)

### Reinforcement

Braided (1) steel wire braid

### Temperature Range

-20°F to 190°F (-29°C to 88°C)

### Packaging

500' reels, maximum 3 pieces, 25' minimum increments

### Branding

Example: Continental ContiTech 1/4" Flexsteel® Service Station Air. Made in U.S.A.

### Couplings

Contact fitting manufacturer for proper fitting recommendation and coupling procedure.

### Order Codes

539-078 (red)  
539-097 (black)

## Flexsteel® Service Station Air

SAP #	ID		Nom. OD		Max. WP		Weight		
	Red	Black	in.	mm	in.	mm	psi	MPa	lb./ft.
20023487	20023860	1/4	6.4	0.61	15.5	250	1.72	0.18	0.28
20023492	20023865	3/8	9.5	0.72	18.3	250	1.72	0.23	0.34

Air & Multipurpose  
General Purpose  
Heavy Duty  
Push-on

Chemical Transfer

Cleaning Equipment

Food  
Transfer  
Washdown

Marine

Material Handling  
Abrasives  
Bulk Transfer  
Cement & Concrete

Mining

Petroleum  
Aircraft Fueling  
Dispensing  
Dock  
Transfer

Spray

Steam

Vacuum

Continental ContiTech

Water  
Discharge  
Suction & Discharge  
Washdown

Welding

Coupling Systems

Equipment

Appendix

# Service Station Air

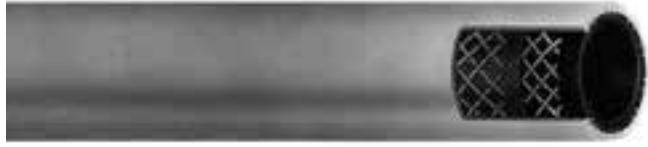

## Product Specifications

### Application

For general air line service stations, automobile repair shops, garages, etc.

### Construction Tube

EPDM synthetic rubber, RMA Class C (Limited Oil Resistance)

### Cover

EPDM synthetic rubber (red)

### Reinforcement

Spiral synthetic yarn

### Temperature Range

-40°F to 190°F (-40°C to 88°C)

### Packaging

500' reels, maximum 3 pieces, 50' increments

### Branding

Example: Service Station Air. Made in the U.S.A. Continental ContiTech

### Couplings

Contact fitting manufacturer for proper fitting recommendation and coupling procedure.

### Order Codes

569-018

## Service Station Air

SAP #	ID		Nom. OD		Max. WP		Weight	
	in.	mm	in.	mm	psi	MPa	lb./ft.	kg/m
20026058	1/4	6.35	0.59	14.99	250	1.72	0.16	0.24
20026063	3/8	9.53	0.71	18.03	250	1.72	0.21	0.31

**Air & Multipurpose**  
General Purpose  
Heavy Duty  
Push-on

Chemical Transfer

Cleaning Equipment

**Food**  
Transfer  
Washdown

Marine

**Material Handling**  
Abrasives  
Bulk Transfer  
Cement & Concrete

Mining

**Petroleum**  
Aircraft Fueling  
Dispensing  
Dock  
Transfer

Spray

Steam

Vacuum

Continental ContiTech

**Water**  
Discharge  
Suction & Discharge  
Washdown

Welding

Coupling Systems

Equipment

Appendix

# Pliovic®



## Product Specifications

### Application

A lightweight, economical general purpose hose for carrying air, water and many spray solutions. Pliovic® is suitable for a wide range of industrial, construction, agricultural hand sprayers and many multipurpose applications. Non-conductive, minimum electrical resistance greater than one (1) megohm per inch of hose length at 1000 volts DC. Available in Pliovic® GS construction or a thick cover, Pliovic® Plus construction. Non-marking cover.

### Construction Tube

Black Pliovic®, RMA Class B (Medium Oil Resistance)

### Cover

Pliovic®, smooth finish, RMA Class B (Medium Oil Resistance)

### Reinforcement

Spiral synthetic yarn

### Temperature Range

-10°F to 158°F (-23°C to 70°C) for GS and Pliovic® Plus 250

### Packaging

1/4"-1/2" - 750' reels, maximum 3 pieces, 50' increments  
 5/8" - 500' reels, maximum 3 pieces, 50' increments (Pliovic® Plus 250 Only)  
 3/4" - 450' reels, maximum 3 pieces, 50' increments (Pliovic® Plus 250 Only)

1" - 400' reels, maximum 3 pieces, 50' increments (Pliovic® Plus 250 Only)

1 1/4"-2" - 300' reels, maximum 3 pieces, 50' increments (Pliovic® Plus 250 Only)

Coupled assemblies available upon request. Contact hose marketing for availability on cut, coiled and tied hose lengths.

### Branding

Example: Pliovic® GS 3/8" ID (9.5mm) 250 psi WP. Made in U.S.A. Continental ContiTech

### Couplings

Contact fitting manufacturer for proper fitting recommendation and coupling procedure.

### Order Codes

See next page.

**Air & Multipurpose**  
 General Purpose  
 Heavy Duty  
 Push-on

Chemical Transfer

Cleaning Equipment

**Food**  
 Transfer  
 Washdown

Marine

**Material Handling**  
 Abrasives  
 Bulk Transfer  
 Cement & Concrete

Mining

**Petroleum**  
 Aircraft Fueling  
 Dispensing  
 Dock  
 Transfer

Spray

Steam

Vacuum

Continental ContiTech

**Water**  
 Discharge  
 Suction & Discharge  
 Washdown

Welding

Coupling Systems

Equipment

Appendix

**Pliovic® GS**

Order Codes: 540-350 (blue), 540-357 (yellow), 540-472 (black), 540-358 (green), 540-406 (red)

SAP #					ID	Nom. OD		Max. WP		Weight		
Blue	Red	Yellow	Black	Green	in.	mm	in.	mm	psi	MPa	lb./ft.	kg/m
20129505	20160220	20629533		20645372	1/4	6.4	0.45	11.4	300	2.07	0.06	0.09
20129506	20566773	20129502	20566772		5/16	7.9	0.59	15.0	300	2.07	0.11	0.16
20129507	20371442	20129503	20351772	20645373	3/8	9.5	0.60	15.2	300	2.07	0.09	0.13
20129508		20129504	20352500	20352636	1/2	12.7	0.78	19.8	300	2.07	0.15	0.22

**Pliovic® Plus 250**

Order Codes: 540-201 (red), 540-227 (blue), 540-232 (green), 540-233 (black), 540-257 (yellow)

SAP #					ID	Nom. OD		Max. WP		Weight		
Blue	Red	Yellow	Black	Green	in.	mm	in.	mm	psi	MPa	lb./ft.	kg/m
20012588	20012644	20012688	20012696	20012742	1/4	6.4	0.50	12.7	250	1.72	0.08	0.12
20012594	20012651	20012689	20012700	20012746	3/8	9.5	0.66	16.8	250	1.72	0.13	0.19
20012605	20012668	20012691	20012703	20012755	1/2	12.7	0.81	20.6	250	1.72	0.17	0.25
20012609	20012677	20012692	20012704	20753492	5/8	15.9	0.94	23.9	250	1.72	0.20	0.30
20012610	20012678	20012694	20012705	20012756	3/4	19.1	1.11	28.2	250	1.72	0.28	0.42
20012615	20012680	20012695	20012707	20012758	1	25.4	1.38	35.1	200	1.38	0.37	0.55

**Air & Multipurpose**  
General Purpose  
Heavy Duty  
Push-on

Chemical Transfer

Cleaning Equipment

**Food**  
Transfer  
Washdown

Marine

**Material Handling**  
Abrasives  
Bulk Transfer  
Cement & Concrete

Mining

**Petroleum**  
Aircraft Fueling  
Dispensing  
Dock  
Transfer

Spray

Steam

Vacuum

Continental ContiTech

**Water**  
Discharge  
Suction & Discharge  
Washdown

Welding

Coupling Systems

Equipment

Appendix

# Braidair™



## Product Specifications

### Application

A quality braided general purpose hose for industrial service, compressor lines, pneumatic tools, water service and low-pressure spray where the need for oil resistance is moderate.

1¼"-1½" - 300' reels, maximum 3 pieces, 50' minimum  
2" - 150-250' carton, maximum 2 pieces, 50' minimum

### Branding

Example: Continental ContiTech Braidair™ 300 psi WP (20 Bar) 3/8" (9.5mm)

### Couplings

Contact fitting manufacturer for proper fitting recommendation and coupling procedure.

### Order Codes

536-422 (1/4" - 1½")  
536-421 (2")

### Construction Tube

Black synthetic, RMA Class A (High Oil Resistance)

### Cover

Red synthetic, RMA Class B (Medium Oil Resistance)

### Reinforcement

Braided (1) synthetic yarn

### Temperature Range

-20°F to 190°F (-29°C to 88°C)

### Packaging

1/4"-1" - 400-750' reels, maximum 3 pieces, 50' minimum

## Braidair™

SAP #	ID	Nom. OD		Max. WP		Weight		
		in.	mm	psi	MPa	lb./ft.	kg/m	
20023152	1/4	6.4	0.55	14.0	300	2.07	0.11	0.16
20023157	3/8	9.5	0.72	18.3	300	2.07	0.18	0.26
20023161	1/2	12.7	0.85	21.6	300	2.07	0.21	0.31
20023163	3/4	19.1	1.13	28.7	300	2.07	0.32	0.48
20023166	1	25.4	1.47	37.3	300	2.07	0.50	0.74
20023168	1¼	31.8	1.80	45.7	300	2.07	0.75	1.12
20023169	1½	38.1	2.09	53.1	300	2.07	1.00	1.49
20023151	2	50.8	2.50	63.5	200	1.38	1.09	1.62

Air & Multipurpose  
General Purpose  
Heavy Duty  
Push-on

Chemical Transfer

Cleaning Equipment

Food  
Transfer  
Washdown

Marine

Material Handling  
Abrasives  
Bulk Transfer  
Cement & Concrete

Mining

Petroleum  
Aircraft Fueling  
Dispensing  
Dock  
Transfer

Spray

Steam

Vacuum

Continental ContiTech

Water  
Discharge  
Suction & Discharge  
Washdown

Welding

Coupling Systems

Equipment

Appendix



# MIL A-A-59565 Military Air Hose



## Product Specifications

### Application

This commercial item description (CID) covers rubber hose and rubber hose assemblies with yarn, cord or fabric reinforcement intended for light-duty air applications. The General Services Administration has authorized the use of this commercial item description for all federal agencies (5:1 Safety Factor).

### Construction Tube

EPDM EPDM, RMA Class C Oil Resistance

### Cover

EPDM EPDM, RMA Class C Oil Resistance

### Reinforcement

2-spiral synthetic cord, 1/4" ID through 5/8" ID  
4-spiral synthetic cord, 3/4" ID through 1 1/4" ID

### Temperature Range

-40°F to 190°F (-40°C to 88°C)

### Packaging

Bulk reels (Alternative packaging specs available upon request)

### Branding

Example: Pneumatic A-A-59565 Continental ContiTech 200 psi WP

### Couplings

Contact fitting manufacturer for proper fitting recommendation and coupling procedure

### Material Code

569-536

## MIL A-A-59565 Military Air Hose

SAP #	Size	ID	Nom. OD		Max. WP		Weight		
Black	Code	in.	mm	in.	mm	psi	MPa	lb./ft.	kg/m
20026886	04	1/4	6.4	0.55	13.9	200	1.38	0.10	0.15
20026893	06	3/8	9.5	0.75	19.1	200	1.38	0.17	0.25
20697646	07	7/16	11.1	0.83	21.2	150	1.03	0.21	0.31
20026900	08	1/2	12.7	0.87	22.2	150	1.03	0.21	0.31
20100167	12	3/4	19.1	1.14	29.0	125	0.86	0.35	0.52
20026909	16	1	25.4	1.52	38.5	125	0.86	0.58	0.86

Air & Multipurpose  
General Purpose  
Heavy Duty  
Push-on

Chemical Transfer

Cleaning Equipment

Food  
Transfer  
Washdown

Marine

Material Handling  
Abrasives  
Bulk Transfer  
Cement & Concrete

Mining

Petroleum  
Aircraft Fueling  
Dispensing  
Dock  
Transfer

Spray

Steam

Vacuum

Continental ContiTech

Water  
Discharge  
Suction & Discharge  
Washdown

Welding

Coupling Systems

Equipment

Appendix

# Heavy Duty



**Air & Multipurpose**  
General Purpose  
Heavy Duty  
Push-on

Chemical Transfer

Cleaning Equipment

**Food**  
Transfer  
Washdown

Marine

**Material Handling**  
Abrasives  
Bulk Transfer  
Cement & Concrete

Mining

**Petroleum**  
Aircraft Fueling  
Dispensing  
Dock  
Transfer

Spray

Steam

Vacuum

LPG Delivery

**Water**  
Discharge  
Suction & Discharge  
Washdown

Welding

Coupling Systems

Equipment

Appendix

	Page	MSHA	Oil Resistance Tube*	Oil Resistance Cover*	Temp. Range	Textile	Wire	Braided	Wrapped Finish
Yellow Air	29		C	C	-40°F to 220°F (-40°C to 104°C)	Yes		Yes	Yes
Yellow Air Plus	30		C	C	-40°F to 220°F (-40°C to 104°C)	Yes		Yes	Yes
Plicord Air Green 400	32		C	C	-25°F to 180°F (-32°C to 82°C)	Yes			Yes
Plicord Super Rock Drill	31	Yes	A	B	-40°F to 220°F (-40°C to 104°C)		Yes		Yes
Steel Air	27	Yes	B	B	-40°F to 200°F (-40°C to 93°C)		Yes	Yes	Yes
Super Ortac	28	Yes	B	B	-20°F to 200°F (-29°C to 93°C)		Yes	Yes	

\*Based on RMA oil classification. For more information, see Appendix C.

# Steel Air



## Product Specifications

### Application

A heavy-duty, wrapped finish, single wire-braid or spiral ply wire air hose for higher pressure service in severe industrial applications, including service in mines, quarries and construction jobs.

### Construction Tube

Black Nitrile synthetic rubber, RMA Class B

### Cover

Yellow Chemivic™ synthetic rubber (wrapped impression), RMA Class B, MSHA approved

### Reinforcement

Braided (1) steel wire (1/2"-1 1/2"). Spiral-plied steel wire (2"-4")

### Temperature Range

-40°F to 200°F (-40°C to 93°C)

### Steel Air

Order Codes: 539-159 (1/2"-1 1/2"), MSHA IC 11/9

SAP #	ID		Nom. OD		Max. WP		Weight	
	in.	mm	in.	mm	psi	MPa	lb./ft.	kg/m
20174720	1/2	12.7	0.91	23.1	750	5.17	0.34	0.51
20174724	3/4	19.1	1.14	29.0	750	5.17	0.45	0.67
20174775	1	25.4	1.45	36.6	750	5.17	0.66	1.00
20174776	1 1/4	31.8	1.81	46.0	500	3.45	0.98	1.46
20317183	1 1/2	38.1	1.98	50.2	500	3.45	0.97	1.44

### Steel Air

Order Codes: 549-209 (2"-4"), MSHA IC 11/7

SAP #	ID		Nom. OD		Max. WP		Weight	
	in.	mm	in.	mm	psi	MPa	lb./ft.	kg/m
20316409	2	50.8	2.66	67.6	500	3.45	1.59	2.36
20317186	2 1/2	63.5	3.33	84.6	500	3.45	2.63	3.91
20316204	3	76.2	3.81	96.8	500	3.45	3.07	4.57

Also available with EPDM synthetic rubber tube and cover where superior heat resistance is more important than oil resistance.

Air & Multipurpose  
General Purpose  
Heavy Duty  
Push-on

Chemical Transfer

Cleaning Equipment

Food  
Transfer  
Washdown

Marine

Material Handling  
Abrasives  
Bulk Transfer  
Cement & Concrete

Mining

Petroleum  
Aircraft Fueling  
Dispensing  
Dock  
Transfer

Spray

Steam

Vacuum

LPG Delivery

Water  
Discharge  
Suction & Discharge  
Washdown

Welding

Coupling Systems

Equipment

Appendix

# Super Ortac®



**Air & Multipurpose**  
General Purpose  
Heavy Duty  
Push-on

Chemical Transfer

Cleaning Equipment

**Food**  
Transfer  
Washdown

Marine

**Material Handling**  
Abrasives  
Bulk Transfer  
Cement & Concrete

Mining

**Petroleum**  
Aircraft Fueling  
Dispensing  
Dock  
Transfer

Spray

Steam

Vacuum

LPG Delivery

**Water**  
Discharge  
Suction & Discharge  
Washdown

Welding

Coupling Systems

Equipment

Appendix

## Product Specifications

### Application

For heavy-duty service in handling air, water, oil, petroleum-based solvents and agricultural spray solutions.

### Construction Tube

Nitrile synthetic rubber, RMA Class B (Medium Oil Resistance)

### Cover

Yellow Chemivic™ synthetic rubber, RMA Class B (Medium Oil Resistance), smooth finish, pinpricked, MSHA approved

### Reinforcement

Braided (1) steel wire

### Temperature Range

-20°F to 200°F (-29°C to 93°C)

### Packaging

1/2"-1" - 500' reels, maximum 3 pieces, 50' increments

1¼"-1½" - 300' reels, maximum 3 pieces, 50' increments  
2" - 100-200' per carton, maximum 3 pieces, 50' increments  
Also stocked in cut and coiled 50' lengths, 2 pieces per carton, all sizes.

### Branding

Example: Continental ContiTech 1" Super Ortac® 1000 psi. Fire Resistant USMSHA IC-11/9. Made in U.S.A.

### Couplings

Contact fitting manufacturer for proper fitting recommendation and coupling procedure.

### Order Codes

539-152

## Super Ortac®

SAP #	ID		Nom. OD		Max. WP		Weight	
	in.	mm	in.	mm	psi	MPa	lb./ft.	kg/m
20024051	1/2	12.7	0.91	23.1	1000	6.9	0.34	0.51
20024056	3/4	19.1	1.14	29.0	1000	6.9	0.44	0.65
20024066	1	25.4	1.45	36.8	1000	6.9	0.63	0.94
20024070	1¼	31.8	1.75	44.5	1000	6.9	0.86	1.28
20024074	1½	38.1	1.98	50.8	1000	6.9	1.08	1.61
20024077	2	50.8	2.55	64.3	1000	6.9	1.57	2.34

# Prospector™ Air



## Product Specifications

### Application

A versatile, heavy-duty air hose for mining, construction and industrial applications.

### Construction Tube

Black EPDM synthetic rubber, RMA Class C (Limited Oil Resistance) (536-509)

Black SBR synthetic rubber, RMA Class C (Limited Oil Resistance) (549-943)

### Cover

Yellow EPDM synthetic rubber (wrapped impression), RMA Class C (Limited Oil Resistance)

### Reinforcement

Braided (1) synthetic yarn (1/2"-2"); Spiral-plied synthetic fabric (2½" - 3")

### Temperature Range

-40°F to 220°F (-40°C to 104°C)

### Packaging

50' length, coiled

### Branding

Example: 1" 24.4mm Yellow Air 300 psi 2.1 MPa WP

### Couplings

Contact fitting manufacturer for proper fitting recommendation and coupling procedure.

### Order Codes

536 -509 (1/2"-1")

549-943 (1 1/4"-3")

## Prospector™ Air

SAP #	ID		Nom. OD		Max. WP		Weight	
	in.	mm	in.	mm	psi	MPa	lb./ft.	kg/m
20070687	1/2	12.7	0.89	22.6	300	2.07	0.24	0.36
20070736	3/4	19.1	1.19	30.2	300	2.07	0.37	0.55
20070739	1	25.4	1.49	37.9	300	2.07	0.53	0.79
20020467	1¼	31.8	1.66	42.2	300	2.07	0.58	0.86
20020471	1½	38.1	2.01	51.1	300	2.07	0.83	1.24
20020475	2	50.8	2.57	65.3	300	2.07	1.20	1.79
20130394	2½	63.7	3.13	79.4	300	2.07	1.56	2.32
20020480	3	76.1	3.56	90.6	300	2.07	1.67	2.48

Air & Multipurpose  
General Purpose  
Heavy Duty  
Push-on

Chemical Transfer

Cleaning Equipment

Food  
Transfer  
Washdown

Marine

Material Handling  
Abrasives  
Bulk Transfer  
Cement & Concrete

Mining

Petroleum  
Aircraft Fueling  
Dispensing  
Dock  
Transfer

Spray

Steam

Vacuum

LPG Delivery

Water  
Discharge  
Suction & Discharge  
Washdown

Welding

Coupling Systems

Equipment

Appendix

# Prospector™ Plus Air



## Product Specifications

### Application

A versatile, heavy-duty air hose for mining, construction and industrial applications where medium pressures are encountered.

### Construction Tube

Black EPDM synthetic rubber (536-508), RMA Class C  
Black EPDM synthetic rubber (549-317)

### Cover

Yellow EPDM (wrapped impression)

### Reinforcement

Braided (1) synthetic yarn (1/2"-1¼"); Spiral-plyed synthetic fabric (1½"-4")

### Temperature Range

-40°F to 220°F (-40°C to 104°C)

### Packaging

50' length, coiled

### Branding

Example: 1" 25.4mm Yellow Air Plus 400 psi 2.8 MPa WP, Continental ContiTech

### Couplings

Contact fitting manufacturer for proper fitting recommendation and coupling procedure.

### Order Codes

536-508 (1/2"-1")  
549-317 (1¼"-4")

## Prospector™ Plus Air

SAP #	ID		Nom. OD		Max. WP		Weight	
	in.	mm	in.	mm	psi	MPa	lb./ft.	kg/m
20070685	1/2	12.7	0.94	23.9	400	2.76	0.24	0.36
20070734	3/4	19.1	1.19	30.2	400	2.76	0.38	0.57
20070738	1	25.4	1.49	37.9	400	2.76	0.54	0.80
20317200	1¼	31.8	1.66	42.2	400	2.76	0.56	0.83
20317201	1½	38.1	2.01	51.1	400	2.76	0.83	1.24
20317204	2	50.8	2.54	64.4	400	2.76	1.08	1.61
20317223	2½	63.5	3.17	80.6	400	2.76	1.70	2.53
20317210	3	76.2	3.66	93.0	400	2.76	2.00	2.98
20317214	4	101.6	4.78	121.5	400	2.76	2.92	4.35

Air & Multipurpose  
General Purpose  
Heavy Duty  
Push-on

Chemical Transfer

Cleaning Equipment

Food  
Transfer  
Washdown

Marine

Material Handling  
Abrasives  
Bulk Transfer  
Cement & Concrete

Mining

Petroleum  
Aircraft Fueling  
Dispensing  
Dock  
Transfer

Spray

Steam

Vacuum

LPG Delivery

Water  
Discharge  
Suction & Discharge  
Washdown

Welding

Coupling Systems

Equipment

Appendix

# Plicord® Super Rock Drill



## Product Specifications

### Application

An extra heavy-duty, high-pressure hose for pneumatic service in mining, construction and industrial service where working conditions are especially severe.

### Construction Tube

Black, heat-resistant Nitrile (ORS) synthetic rubber, RMA Class A (High Oil Resistance)

### Cover

Blue Chemivic™ synthetic with spiral yellow transfer stripe (wrapped impression) MSHA approved, RMA Class B (Medium Oil Resistance)

### Reinforcement

Spiral-plied steel wire

### Temperature Range

-40°F to 220°F (-40°C to 104°C)

### Packaging

100' length, coiled, polywrapped

### Branding (Spiral)

Example: Continental ContiTech Plicord® Super Rock Drill ORS 500 psi WP

### Couplings

Contact fitting manufacturer for proper fitting recommendation and coupling procedure.

### Order Codes

549-285

## Plicord® Super Rock Drill

SAP #	ID		Nom. OD		Max. WP		Weight	
	in.	mm	in.	mm	psi	MPa	lb./ft.	kg/m
20316205	2½	63.5	3.45	87.7	500	3.45	2.96	4.40
	3	76.2	3.94	100.1	500	3.45	3.44	5.12
	4	101.6	4.96	126.0	400	2.76	4.55	6.77

Air & Multipurpose  
General Purpose  
Heavy Duty  
Push-on

Chemical Transfer

Cleaning Equipment

Food  
Transfer  
Washdown

Marine

Material Handling  
Abrasives  
Bulk Transfer  
Cement & Concrete

Mining

Petroleum  
Aircraft Fueling  
Dispensing  
Dock  
Transfer

Spray

Steam

Vacuum

LPG Delivery

Water  
Discharge  
Suction & Discharge  
Washdown

Welding

Coupling Systems

Equipment

Appendix

# Plicord® Air Green 400



## Product Specifications

### Application

A versatile, heavy-duty air hose for use in rough industrial applications or for severe service in mines, quarries and construction jobs.

### Construction Tube

Black SBR synthetic rubber, RMA Class C (Limited Oil Resistance) (non-conductive)

### Cover

Green SBR synthetic rubber (wrapped impression), RMA Class C (Limited Oil Resistance)

### Reinforcement

Spiral-plyed synthetic fabric

### Temperature Range

-25°F to 180°F (-32°C to 82°C)

### Packaging

100' length, coiled, polywrapped

### Branding (Spiral)

Example: Continental ContiTech Plicord® Air Green 400 psi WP

### Couplings

Contact fitting manufacturer for proper fitting recommendation and coupling procedure.

### Order Codes

549-006

## Plicord® Air Green 400

SAP #	ID		Nom. OD		Max. WP		Weight	
	Green	in.	mm	in.	mm	psi	MPa	lb./ft.
20018818	1/2	12.7	0.880	22.4	400	2.76	0.23	0.34
20018820	3/4	19.1	1.230	31.2	400	2.76	0.45	0.67
20018823	1	25.4	1.500	38.1	400	2.76	0.58	0.86
20159322	1¼	31.8	1.790	45.5	400	2.76	0.74	1.10
20018828	1½	38.1	2.040	51.8	400	2.76	0.86	1.28
20018830	2	50.8	2.546	64.7	400	2.76	1.11	1.65
20018831	2½	63.5	3.156	80.2	400	2.76	1.64	2.44
20018832	3	76.2	3.700	94.0	400	2.76	2.14	3.18

Air & Multipurpose  
General Purpose  
Heavy Duty  
Push-on

Chemical Transfer

Cleaning Equipment

Food  
Transfer  
Washdown

Marine

Material Handling  
Abrasives  
Bulk Transfer  
Cement & Concrete

Mining

Petroleum  
Aircraft Fueling  
Dispensing  
Dock  
Transfer

Spray

Steam

Vacuum

LPG Delivery

Water  
Discharge  
Suction & Discharge  
Washdown

Welding

Coupling Systems

Equipment

Appendix





# Push-On



**Air & Multipurpose**  
 General Purpose  
 Heavy Duty  
 Push-on

Chemical Transfer

Cleaning Equipment

**Food**  
 Transfer  
 Washdown

Marine

**Material Handling**  
 Abrasives  
 Bulk Transfer  
 Cement & Concrete

Mining

**Petroleum**  
 Aircraft Fueling  
 Dispensing  
 Dock  
 Transfer

Spray

Steam

Vacuum

LPG Delivery

**Water**  
 Discharge  
 Suction & Discharge  
 Washdown

Welding

Coupling Systems

Equipment

Appendix

	Page	Superior Abrasion Cover	MSHA	Non-conductive	Oil Resistance Tube*	Oil Resistance Cover*	Braided	Robotic Service	General Industrial
Insta-Grip 250	36			Yes	A	B			Yes
Insta-Grip 300	35		Yes	Yes	A	B	Yes		Yes
Insta-Grip TC	37				A	B	Yes		Yes
Insta-Grip Plus	38	Yes	Yes	Yes	A	A	Yes	Yes	Yes

\*Based on RMA oil classification. For more information, see Appendix C.

# Insta-Grip™ 300



**Air & Multipurpose**  
General Purpose  
Heavy Duty  
Push-on

Chemical Transfer

Cleaning Equipment

**Food**  
Transfer  
Washdown

Marine

**Material Handling**  
Abrasives  
Bulk Transfer  
Cement & Concrete

Mining

**Petroleum**  
Aircraft Fueling  
Dispensing  
Dock  
Transfer

Spray

Steam

Vacuum

LPG Delivery

**Water**  
Discharge  
Suction & Discharge  
Washdown

Welding

Coupling Systems

Equipment

Appendix

## Product Specifications

### Application

For use with push-on fittings at working pressures of 300 psi. For low-pressure hydraulic and pneumatic systems such as shop air systems, general industrial, maintenance and automotive assembly applications. Non-conductive, minimum electrical resistance, greater than one (1) megohm per inch of hose length at 1000 volts DC. MSHA approved covers.

### Construction Tube

Silicone is not used in the manufacturing of this hose. Chemivic™ oil and heat-resistant synthetic rubber, RMA Class A (High Oil Resistance)

### Cover

Black, Green, Blue, Red, Yellow and Gray (others: contact customer service); MSHA approved, weather, abrasion and oil-resistant synthetic rubber. RMA Class B. (Medium Oil Resistance)

### Reinforcement

Braided (1) high-strength synthetic yarn laid at the most effective angle for maximum strength and coupling holding ability

### Temperature Range

-40°F to 190°F (-40°C to 88°C)

### Packaging

500' reels, maximum 4 pieces, 10' minimum

### Branding

Example: Insta-Grip™ 1/4" 300 psi WP Flame Resistant USMSHA 2G-IC-14C/33. Made in U.S.A. Continental ContiTech

### Couplings

Contact fitting manufacturer for proper fitting recommendation and coupling procedure.

### Order Codes

- 535-278 (black)
- 535-279 (green)
- 535-294 (gray)
- 535-280 (red)
- 535-281 (blue)
- 535-277 (yellow)

## Insta-Grip™ 300

SAP #						ID		Nom. OD		Max. WP		Bend Radius Weight			
Black	Green	Gray	Red	Blue	Yellow	in.	mm	in.	mm	psi	MPa	in.	mm	lb./ft.	kg/m
20474584						1/4	6.4	0.54	13.7	300	2.07	3	64	0.09	0.13
20022636	20022656	20022816	20022666	20022677	20447145	3/16	4.8	0.38	9.7	300	2.07	3	64	0.05	0.07
20022644	20022658	20022819	20022668	20022681	20447146	3/8	9.5	0.69	17.5	300	2.07	3	76	0.14	0.21
20022648	20022661	20022823	20022671	20022684	20295159	1/2	12.7	0.81	20.6	300	2.07	5	127	0.17	0.25
20022651	20022663	20022825	20022673	20022685		5/8	15.9	0.93	23.6	300	2.07	6	152	0.20	0.30
20022653	20022664	20022826	20022674	20022686	20237027	3/4	19.1	1.07	27.2	300	2.07	7	178	0.26	0.39

# Insta-Grip™ 250



**Air & Multipurpose**  
General Purpose  
Heavy Duty  
Push-on

Chemical Transfer

Cleaning Equipment

**Food**  
Transfer  
Washdown

Marine

**Material Handling**  
Abrasives  
Bulk Transfer  
Cement & Concrete

Mining

**Petroleum**  
Aircraft Fueling  
Dispensing  
Dock  
Transfer

Spray

Steam

Vacuum

LPG Delivery

**Water**  
Discharge  
Suction & Discharge  
Washdown

Welding

Coupling Systems

Equipment

Appendix

## Product Specifications

### Application

For use with push-on fittings at working pressures of 250 psi for industrial service. Non-conductive, minimum electrical resistance greater than one (1) megohm per inch of hose length at 1000 volts DC.

### Construction Tube

Chemivic™ oil- and heat-resistant synthetic rubber, RMA Class A (High Oil Resistance)

### Cover

Red, Black, or Green Chemivic™, RMA Class B (Medium Oil Resistance)

### Reinforcement

Spiral aramid yarn

### Temperature Range

-20°F to 190°F (-29°C to 88°C)

### Packaging

500' reels, maximum 3 pieces, 50' increments

### Branding

Example: Insta-Grip™ Non-conductive 3/8" (9.5mm) 250 psi WP. Made in U.S.A. Continental ContiTech

### Couplings

Contact fitting manufacturer for proper fitting recommendation and coupling procedure.

### Order Codes

- 569-013 (red)
- 569-014 (black)
- 569-015 (green)
- 569-016 (gray)

## Insta-Grip™ 250

SAP #	ID				Nom. OD		Max. WP		Weight		
	Red	Black	Green	Gray	in.	mm	in.	mm	psi	MPa	lb./ft.
20025988	20026001	20026043	20160048	1/4	6.4	0.51	12.7	250	1.72	0.08	0.12
20025994	20026012	20026046	20026055	3/8	9.5	0.65	16.5	250	1.72	0.12	0.18
20025999	20026030	20026050	20026057	1/2	12.7	0.80	20.3	250	1.72	0.17	0.25
20026035	20026035	20475077	20195088	5/8	15.9	0.94	23.9	250	1.72	0.23	0.34
20026037	20026037		20195089	3/4	19.1	1.08	27.4	250	1.72	0.28	0.42

# Insta-Grip™ TC



**Air & Multipurpose**  
 General Purpose  
 Heavy Duty  
 Push-on

Chemical Transfer

Cleaning Equipment

**Food**  
 Transfer  
 Washdown

Marine

**Material Handling**  
 Abrasives  
 Bulk Transfer  
 Cement & Concrete

Mining

**Petroleum**  
 Aircraft Fueling  
 Dispensing  
 Dock  
 Transfer

Spray

Steam

Vacuum

LPG Delivery

**Water**  
 Discharge  
 Suction & Discharge  
 Washdown

Welding

Coupling Systems

Equipment

Appendix

## Product Specifications

### Application

For low-pressure hydraulic and pneumatic systems such as shop air systems, general industrial, maintenance and automotive assembly applications.

### Construction Tube

Chemivic™ oil and heat-resistant synthetic rubber, RMA Class A (High Oil Resistance)

### Cover

Black, dyed textile braid, mildew and oil-resistant

### Reinforcement

Braided (1) high-strength synthetic yarn laid at an angle for strength and coupling holding ability

### Temperature Range

-40°F to 190°F (-40°C to 88°C)

### Packaging

500' reels, maximum 4 pieces, 10' minimum length

### Branding

Example: Insta-Grip™ TC 3/8" 300 psi WP. Made in U.S.A. Continental ContiTech

### Couplings

Contact fitting manufacturer for proper fitting recommendation and coupling procedure.

### Order Codes

535-230

## Insta-Grip™ TC

SAP #	ID		Nom. OD		Max. WP		Bend Radius		Weight	
	in.	mm	in.	mm	psi	MPa	in.	mm	lb./ft.	kg/m
20022593	1/4	6.4	0.50	12.7	300	2.07	3	64	0.08	0.12
20022595	5/16	7.9	0.56	14.2	300	2.07	3	76	0.09	0.13
20022597	3/8	9.5	0.64	16.3	300	2.07	3	76	0.11	0.16
20022600	1/2	12.7	0.75	19.1	300	2.07	5	127	0.13	0.19
20022602	5/8	15.9	0.91	23.1	300	2.07	6	152	0.19	0.28
20022604	3/4	19.1	1.03	26.2	300	2.07	7	178	0.21	0.31

# Insta-Grip Plus™



## Product Specifications

### Application

For use with push-on fittings at maximum working pressures of 400 psi\*. For low-pressure hydraulic pneumatic systems such as robotics, shop air systems, general industrial, maintenance and automotive assembly applications. Non-conductive, minimum electrical resistance greater than one (1) megohm per inch of hose length at 1000 volts DC. MSHA approved covers.

### Construction Tube

Chemivic™ oil and heat-resistant synthetic rubber, RMA Class A (High Oil Resistance)

### Cover

MSHA approved Black (USMSHA 2G-1C-14C/27). Blue, Gray, Green, Red, White, Brown and Yellow (USMSHA 2G-1C-14C/28) (others: contact customer service), weather, abrasion and oil-resistant Carbryn™ rubber, RMA Class A (High Oil Resistance)

### Reinforcement

Braided (1) high-strength synthetic yarn laid at an angle for strength and coupling holding ability

### Temperature Range

-40°F to 200°F (-40°C to 93°C)

### Packaging

500' reels, maximum 4 pieces, 10' minimum length

### Branding

Example: Insta-Grip Plus™ Non-conductive 3/8" 400 psi WP; Flame Resistant; USMSHA 2G-1C-14C/27. Made in U.S.A. Continental ContiTech

### Couplings

Contact fitting manufacturer for proper fitting recommendation and coupling procedure.

### Order Codes

- 535-283 (black)
- 535-284 (blue)
- 535-285 (gray)
- 535-286 (green)
- 535-289 (red)
- 535-290 (white)
- 535-292 (brown)
- 535-551 (yellow)

Air & Multipurpose  
General Purpose  
Heavy Duty  
Push-on

Chemical Transfer

Cleaning Equipment

Food  
Transfer  
Washdown

Marine

Material Handling  
Abrasives  
Bulk Transfer  
Cement & Concrete

Mining

Petroleum  
Aircraft Fueling  
Dispensing  
Dock  
Transfer

Spray

Steam

Vacuum

LPG Delivery

Water  
Discharge  
Suction & Discharge  
Washdown

Welding

Coupling Systems

Equipment

Appendix

\*1-inch rated at 300 psi.

**Insta-Grip Plus™**

SAP #				ID		Nom. OD		Max. WP		Bend Radius		Weight	
Black	Blue	Gray	Green	in.	mm	in.	mm	psi	MPa	in.	mm	lb./ft.	kg/m
20022699				3/16	4.8	0.36	9.1	400	2.76	3	64	0.04	0.06
20022700	20022719	20022736	20022750	1/4	6.4	0.51	13.0	400	2.76	3	64	0.08	0.12
20022703	20022722	20022739	20022752	3/8	9.5	0.67	17.0	400	2.76	3	76	0.13	0.19
20022706	20022726	20022742	20022754	1/2	12.7	0.76	19.3	400	2.76	5	127	0.14	0.21
20022711	20022730	20022745	20022757	5/8	15.9	0.93	23.6	400	2.76	6	152	0.19	0.28
20022714	20022732	20022747	20022759	3/4	19.1	1.06	26.9	400	2.76	7	178	0.26	0.37
20141684	20146787	20148619	20146786	1	25.4	1.34	34.0	300	2.07	8	203	0.34	0.51

**Insta-Grip Plus™**

SAP #				ID		Nom. OD		Max. WP		Bend Radius		Weight	
Red	White	Brown	Yellow	in.	mm	in.	mm	psi	MPa	in.	mm	lb./ft.	kg/m
				3/16	4.8	0.36	9.1	400	2.76	3	64	0.04	0.06
20022767	20022782	20022806	20022827	1/4	6.4	0.51	13.0	400	2.76	3	64	0.08	0.12
20022772	20022784	20022808	20022829	3/8	9.5	0.67	17.0	400	2.76	3	76	0.13	0.19
20022775	20022786	20022810	20022830	1/2	12.7	0.76	19.3	400	2.76	5	127	0.14	0.21
20022777			20022832	5/8	15.9	0.93	23.6	400	2.76	6	152	0.19	0.28
20022779	20022789	20022812	20022833	3/4	19.1	1.06	26.9	400	2.76	7	178	0.26	0.37
20112353				1	25.4	1.34	34.0	300	2.07	8	203	0.34	0.51

Air & Multipurpose  
General Purpose  
Heavy Duty  
Push-on

Chemical Transfer

Cleaning Equipment

Food  
Transfer  
Washdown

Marine

Material Handling  
Abrasives  
Bulk Transfer  
Cement & Concrete

Mining

Petroleum  
Aircraft Fueling  
Dispensing  
Dock  
Transfer

Spray

Steam

Vacuum

LPG Delivery

Water  
Discharge  
Suction & Discharge  
Washdown

Welding

Coupling Systems

Equipment

Appendix

# Chemical Transfer



**Air & Multipurpose**  
 General Purpose  
 Heavy Duty  
 Push-on

**Chemical Transfer**

Cleaning Equipment

**Food**  
 Transfer  
 Washdown

Marine

**Material Handling**  
 Abrasives  
 Bulk Transfer  
 Cement & Concrete

Mining

**Petroleum**  
 Aircraft Fueling  
 Dispensing  
 Dock  
 Transfer

Spray

Steam

Vacuum

LPG Delivery

**Water**  
 Discharge  
 Suction & Discharge  
 Washdown

Welding

Coupling Systems

Equipment

Appendix

	Page	Temp. Range*	Superior Flexibility	Superior Abrasion Cover	Cover Color
Brown Flexwing	46	-30°F to 275°F (-34°C to 135°C)	Yes		Brown
Chem One	42	-40°F to 250°F (-40°C to 121°C)	Yes	Yes	Black
DEF Transfer Hose	43	-40°F to 257°F (-40°C to 125°C)			Black
Fabchem	45	-40°F to 150°F (-40°C to 66°C)	Yes		Green
Green XLPE	41	-25°F to 150°F (-32°C to 66°C)			Green
HI-PER	47	-40°F to 300°F (-40°C to 149°C)			Blue
Orange Flexwing	48	-25°F to 250°F (-32°C to 121°C)			Orange
Plicord ExtremeFlex Brown	50	-30°F to 275°F (-34°C to 135°C)			Brown
Plicord ExtremeFlex Purple	51	-40°F to 221°F (-40°C to 105°C)			Purple
Purple Flexwing	49	-40°F to 221°F (-40°C to 105°C)	Yes		Purple
Viper	44	-40°F to 250°F (-40°C to 121°C)	Yes	Yes	Black

\*Temperature is contingent on the specific chemical conveyed.



# Green XLPE Cross Link Polyethylene



## Product Specifications

### Application

Handles the majority of today's industrial chemicals in pressure, gravity flow or suction service.

### Construction Tube

Clear Spectar® synthetic rubber Cross-Linked Polyethylene (XLPE)

### Cover

Green EPDM synthetic rubber with spiral white stripe (wrapped impression)

### Reinforcement

Spiral-plied synthetic fabric with double wire helix

### Temperature Range

-25°F to 150°F (-32°C to 66°C)

### Packaging

100' exact length, coiled, polywrapped

### Branding (Spiral)

Example: Continental ContiTech XLPE Chemical Transfer 150 psi

### Couplings

Use Continental ContiTech Insta-Lock™ Cam & Groove Fittings with this product. See the Coupling Systems information pages at the back of the catalog.

### Order Codes

546-666 (1/2"-4")  
541-666 (6")

## Green XLPE

SAP #	ID		Nom. OD		Max. WP		Bend Radius		Vacuum HG		Weight	
	in.	mm	in.	mm	psi	MPa	in.	mm	in.	mm	lb./ft.	kg/m
20018685	1/2	12.7	0.97	24.6	150	1.03	6	152	29	737	0.31	0.46
20018688	3/4	19.1	1.23	31.2	150	1.03	7	178	29	737	0.44	0.65
20018690	1	25.4	1.47	37.3	150	1.03	8	203	29	737	0.54	0.80
20018694	1¼	31.8	1.73	43.9	150	1.03	9	229	29	737	0.66	0.98
20018697	1½	38.1	2.03	51.6	150	1.03	10	254	29	737	0.92	1.37
20018700	2	50.8	2.61	66.3	150	1.03	12	305	29	737	1.32	1.96
20018704	2½	63.5	3.11	79.0	150	1.03	15	381	29	737	1.65	2.46
20018707	3	76.2	3.61	91.7	150	1.03	18	457	29	737	2.02	3.01
20018709	4	101.6	4.69	119.1	150	1.03	24	610	29	737	2.95	4.39
20706595	6	152.4	6.86	174.1	150	1.03	36	900	29	737	6.07	9.04

Note: Refer to the Continental ContiTech Chemical Resistance Charts pages in Appendix B for specific chemical and temperature compatibility.

Air & Multipurpose  
General Purpose  
Heavy Duty  
Push-on

Chemical Transfer

Cleaning Equipment

Food  
Transfer  
Washdown

Marine

Material Handling  
Abrasives  
Bulk Transfer  
Cement & Concrete

Mining

Petroleum  
Aircraft Fueling  
Dispensing  
Dock  
Transfer

Spray

Steam

Vacuum

LPG Delivery

Water  
Discharge  
Suction & Discharge  
Washdown

Welding

Coupling Systems

Equipment

Appendix

# Chem One™



## Product Specifications

### Application

For the transfer of a variety of current industrial chemicals used today. (Refer to Continental ContiTech Chemical Resistance Guide for compatibility.) For use in pressure, gravity flow and/or suction service.

### Construction Tube

Alphasyn® Modified Cross-Linked Polyethylene (Mod XLPE)

### Cover

Black corrugated abrasion-resistant Omegasyn™ EPDM with Red Spiral Stripe

### Reinforcement

Spiral-plied synthetic fabric with double wire helix

### Temperature Range

-40°F to 250°F (-40°C to 121°C)

### Packaging

Coiled and polywrapped. Contact customer service for cut length.

### Branding

Example: Chem One™ chemical transfer hose Alphasyn® 200 psi WP, Continental ContiTech

### Couplings

Use Continental ContiTech Insta-Lock™ Cam & Groove Fittings with this product.

### Order Codes

546-661

## Chem One™

SAP #	ID	Nom. OD		Max. WP		Bend Radius		Vacuum HG		Weight		
		in.	mm	in.	mm	in.	mm	in.	mm	lb./ft.	kg/m	
20408836	3/4	19.0	1.2	30.5	200	1.38	2	50.8	29	737	0.39	0.58
20408837	1	25.3	1.4	36.8	200	1.38	3	76.2	29	737	0.49	0.73
20408838	1¼	32.0	1.6	42.2	200	1.38	3	76.2	29	737	0.53	0.78
20408870	1½	38.0	1.9	48.3	200	1.38	4	101.6	29	737	0.63	0.93
20408871	2	51.0	2.4	61.8	200	1.38	5	127.0	29	737	0.86	1.28
20408872	2½	63.0	2.9	75.6	200	1.38	6	152.4	29	737	1.24	1.84
20408873	3	76.0	3.4	88.1	200	1.38	8	203.2	29	737	1.46	2.17
20408813	4	102.0	4.5	115.0	200	1.38	11	279.4	29	737	2.06	3.06



Air & Multipurpose  
General Purpose  
Heavy Duty  
Push-on

Chemical Transfer

Cleaning Equipment

Food  
Transfer  
Washdown

Marine

Material Handling  
Abrasives  
Bulk Transfer  
Cement & Concrete

Mining

Petroleum  
Aircraft Fueling  
Dispensing  
Dock  
Transfer

Spray

Steam

Vacuum

LPG Delivery

Water  
Discharge  
Suction & Discharge  
Washdown

Welding

Coupling Systems

Equipment

Appendix

# DEF Transfer Hose



## Product Specifications

### Application

Continental DEF Dispensing Hose is specifically designed to convey the high-purity, aqueous urea solution DEF.

### Packaging

100 ft lengths

### Construction Tube

Pliosyn™ Ultra-High Molecular Weight Polyethylene (UHMWPE) with proprietary backing. Tube tested per iso 22241-2 immersion test at independent lab to confirm compatibility with DEF aqueous solution.

### Branding

Example: Continental ContiTech DEF Transfer Hose 3/4" (19.1mm), Continental ContiTech DEF Transfer Hose (Date Code) Made in Canada

### Cover

Black corrugated EPDM

### Couplings

Contact fitting manufacturer for proper fitting recommendation.

### Reinforcement

Spiral-plied synthetic fabric with double wire helix

### Order Codes

546-552

### Temperature Range

-40°F to 140°F (-40°C to 60°C)

## DEF Transfer Hose

Features	Benefits
Enhanced manufacturing practices	Significantly reduces contamination that can clog an SCR system and stop a truck
Premium braided construction	Reduced volumetric expansion to meet Weights and Measures system criteria
Static Wire	Requirement for installations in Class I, Division 1 areas as outlined in NFPA 70
Meets ISO 22241 standard	Ensures desirable characteristics of AUS 32 (DEF) are met, such as quality, safety, reliability and contamination

## DEF Transfer Hose

SAP #	ID	Nom. OD		Max. WP	Bend Radius		Vacuum HG		Weight		
		in.	mm		in.	mm	in.	mm	lb./ft.	kg/m	
20741106	1	25.4	1.45	37.3	250	4	102	29	737	0.42	0.89
20738416	1½	38.1	1.97	50	250	5	127	29	737	0.84	1.25
20738464	2	50.8	2.55	64.8	250	6	152	29	737	1.22	1.82
20738465	3	76.2	3.63	92.2	250	9	229	29	737	2.11	3.14

\*Alternate packaging specs available upon request

**Air & Multipurpose**  
General Purpose  
Heavy Duty  
Push-on

**Chemical Transfer**

Cleaning Equipment

**Food**  
Transfer  
Washdown

Marine

**Material Handling**  
Abrasives  
Bulk Transfer  
Cement & Concrete

Mining

**Petroleum**  
Aircraft Fueling  
Dispensing  
Dock  
Transfer

Spray

Steam

Vacuum

LPG Delivery

**Water**  
Discharge  
Suction & Discharge  
Washdown

Welding

Coupling Systems

Equipment

Appendix

# Viper™



Air & Multipurpose  
General Purpose  
Heavy Duty  
Push-on

Chemical Transfer

Cleaning Equipment

Food  
Transfer  
Washdown

Marine

Material Handling  
Abrasives  
Bulk Transfer  
Cement & Concrete

Mining

Petroleum  
Aircraft Fueling  
Dispensing  
Dock  
Transfer

Spray

Steam

Vacuum

LPG Delivery

Water  
Discharge  
Suction & Discharge  
Washdown

Welding

Coupling Systems

Equipment

Appendix

## Product Specifications

### Application

For the transfer of a variety of industrial chemicals used today. (Refer to Continental ContiTech Chemical Resistance Guide for compatibility.) For use in pressure, gravity flow and/or suction service. Hose may be cleaned using open-end steam up to 50 psi or in a bath containing 10% Sodium Hydroxide (NaOH), up to 212°F (100°C).

### Construction Tube

Beige Alphasyn® Modified Cross-Linked Polyethylene (Modified XLPE)

### Cover

Black Omegasyn™ abrasion-resistant EPDM with white spiral stripe

### Reinforcement

Spiral-plied synthetic fabric with double wire helix

### Temperature Range

-40°F to 250°F (-40°C to 121°C)

### Packaging

100' length coiled, polywrapped

### Branding (Spiral)

Example: Continental ContiTech Viper™ Chemical Transfer Alphasyn® 200 psi WP

### Couplings

Fittings should be permanently attached for fluid temperatures above 125°F (52°C) and up to 250°F (121°C). Use Continental ContiTech Insta-Lock™ Cam & Groove Fittings with this product. See the Couplings Systems information pages at the back of the catalog.

### Order Codes

546-345

## Viper™

SAP #	ID	Nom. OD		Max. WP		Bend Radius		Vacuum HG		Weight		
		in.	mm	psi	MPa	in.	mm	in.	mm	lb./ft.	kg/m	
20106813	1	25.4	1.45	36.9	200	1.38	4	100	29	737	0.53	0.79
20091802	1½	38.1	1.95	49.6	200	1.38	5	125	29	737	0.74	1.10
20091803	2	50.8	2.54	64.5	200	1.38	7	175	29	737	1.16	1.73
20069573	2½	63.5	3.05	77.5	200	1.38	8	200	29	737	1.41	2.10
20091805	3	76.2	3.59	91.2	200	1.38	10	250	29	737	1.82	2.71
20123987	4	101.6	4.64	117.8	200	1.38	14	350	29	737	2.42	3.61

Note: Refer to the Continental ContiTech Chemical Resistance Charts pages in Appendix B for specific chemical and temperature compatibility.

Viper™ chemical hose will handle fluid up to 250°F (121°C), however, this rating is contingent on the specific chemical conveyed. Contact Customer Service at 1-800-235-4632 for any chemical above the temperature stated in the Continental ContiTech Chemical Resistance Guide. Refer to the Continental ContiTech Chemical Resistance Chart for Specific Chemical and Temperature Compatibility.

# Fabchem™ Pliosyn™ (UHMWPE) Tube



**Air & Multipurpose**  
 General Purpose  
 Heavy Duty  
 Push-on

**Chemical Transfer**

Cleaning Equipment

**Food**  
 Transfer  
 Washdown

Marine

**Material Handling**  
 Abrasives  
 Bulk Transfer  
 Cement & Concrete

Mining

**Petroleum**  
 Aircraft Fueling  
 Dispensing  
 Dock  
 Transfer

Spray

Steam

Vacuum

LPG Delivery

**Water**  
 Discharge  
 Suction & Discharge  
 Washdown

Welding

Coupling Systems

Equipment

Appendix

## Product Specifications

### Application

A significant improvement to our chemical hose line. It handles the majority of common industrial chemicals in pressure, gravity flow and suction service.

### Branding (Spiral)

Example: Continental ContiTech Fabchem™ Chemical Transfer Hose, 200 psi WP

### Construction Tube

Pliosyn™ Ultra-High Molecular Weight Polyethylene (UHMWPE)

### Couplings

Use Continental ContiTech Insta-Lock™ Cam & Groove Fittings with this product. See the Coupling Systems information pages at the back of the catalog.

### Cover

Green EPDM synthetic rubber with bright orange longitudinal stripe, corrugated (wrapped impression)

### Order Codes

546-065 Green Cover, 546-533 Purple Cover

### Reinforcement

Spiral-plied synthetic fabric with double wire helix

### Temperature Range

-40°F to 150°F (-40°C to 66°C)

### Packaging

100' exact length, coiled, polywrapped

## Fabchem™ Pliosyn™ (UHMWPE) Tube

SAP #		ID		Nom. OD		Max. WP		Bend Radius		Vacuum HG		Weight		
Green	Purple	Blue	in.	mm	in.	mm	psi	MPa	in.	mm	in.	mm	lb./ft.	kg/m
20018477		20617876	1/2	12.7	0.95	24.1	200	1.38	3	76	29	737	0.33	0.49
20018478		20617877	3/4	19.1	1.22	31.0	200	1.38	4	89	29	737	0.46	0.68
20018481	20673999	20243623	1	25.4	1.47	37.3	200	1.38	4	102	29	737	0.60	0.89
20018485			1¼	31.8	1.73	43.9	200	1.38	4	102	29	737	0.73	1.09
20018488	20674040	20385256	1½	38.1	1.97	50.0	200	1.38	5	127	29	737	0.84	1.25
20018493	20674041	20598926	2	50.8	2.55	64.8	200	1.38	6	152	29	737	1.22	1.82
20018496			2½	63.5	3.14	79.8	200	1.38	8	203	29	737	1.78	2.65
20018498			3	76.2	3.63	92.2	200	1.38	9	229	29	737	2.11	3.14
20018502			4	101.6	4.67	118.6	200	1.38	10	254	29	737	2.81	4.18
		20579508	6	152.4	6.88	175	200	1.38	18	457	29	737	5.98	8.90

Note: Refer to the Continental ContiTech Chemical Resistance Charts pages in Appendix B for specific chemical and temperature compatibility.

# Brown Flexwing® Chemrin® (CPE) Tube



## Product Specifications

### Application

A versatile chemical hose capable of handling a wide variety of acids, alcohols, salt solutions and petroleum-based products.

### Construction Tube

Black Chemrin® synthetic rubber

### Cover

Brown EPDM synthetic rubber with white spiral brand (wrapped impression)

### Reinforcement

Spiral-plied synthetic fabric with double wire helix

### Temperature Range

-30°F to 275°F (-34°C to 135°C)

### Packaging

100' exact length, coiled, polywrapped

### Branding (Spiral)

Example: Continental ContiTech Brown Flexwing® with Chemrin® 150 psi WP

### Couplings

Use Continental ContiTech Insta-Lock™ Cam & Groove Fittings with this product. See the Coupling Systems information pages at the back of the catalog.

### Order Codes

546-069

541-069 (Custom lengths with fittings.)

## Brown Flexwing®

SAP #	ID		Nom. OD		Max. WP		Bend Radius		Vacuum HG		Weight	
	in.	mm	in.	mm	psi	MPa	in.	mm	in.	mm	lb./ft.	kg/m
20018560	3/4	19.1	1.22	31.0	150	1.03	3	76	29	737	0.45	0.67
20018561	1	25.4	1.47	37.3	150	1.03	4	89	29	737	0.57	0.85
20018567	1¼	31.8	1.73	43.9	150	1.03	4	102	29	737	0.69	1.03
20018569	1½	38.1	2.02	51.3	150	1.03	4	102	29	737	0.95	1.41
20018571	2	50.8	2.55	64.8	150	1.03	5	127	29	737	1.26	1.88
20263622	2½	63.5	3.09	78.5	150	1.03	6	152	29	737	1.71	2.54
20018573	3	76.2	3.61	91.7	150	1.03	7	178	29	737	2.11	3.14
20018574	4	101.6	4.69	119.1	150	1.03	10	254	29	737	3.04	4.52
20014953	6	152.4	6.91	175.5	150	1.03	30	762	29	737	6.32	9.41

Note: Refer to the Continental ContiTech Chemical Resistance Charts pages in Appendix B for specific chemical and temperature compatibility.

Air & Multipurpose  
General Purpose  
Heavy Duty  
Push-on

Chemical Transfer

Cleaning Equipment

Food  
Transfer  
Washdown

Marine

Material Handling  
Abrasives  
Bulk Transfer  
Cement & Concrete

Mining

Petroleum  
Aircraft Fueling  
Dispensing  
Dock  
Transfer

Spray

Steam

Vacuum

LPG Delivery

Water  
Discharge  
Suction & Discharge  
Washdown

Welding

Coupling Systems

Equipment

Appendix

# Hi-Per®



## Product Specifications

### Application

A premium hose which is FEP lined to handle a broad spectrum of fluids and materials in a wide variety of applications.

### Construction Tube

FEP has FDA/USDA compliant materials

### Cover

Blue EPDM synthetic rubber with bright orange spiral transfer tape (wrapped impression)

### Reinforcement

Spiral-plied synthetic fabric with double wire helix

### Temperature Range

-40°F to 300°F (-40°C to 149°C)

### Packaging

Custom lengths available (minimum 5')

### Branding (Spiral)

Example: Continental ContiTech Hi-Per® Universal Chemical Hose FEP lined

### Couplings

Use Continental ContiTech Insta-Lock™ Cam & Groove Fittings with this product. See the Coupling Systems information pages at the back of the catalog.

### Non-Stock/Sizes

Order in increments of 100' for 1/2"-2"

Order in increments of 60' for 2½" and larger sizes

### Order Codes

546-256

### Hi-Per®

SAP #	ID		Nom. OD		Max. WP		Bend Radius		Vacuum HG		Weight	
	in.	mm	in.	mm	psi	MPa	in.	mm	in.	mm	lb./ft.	kg/m
20018637	1/2	12.7	0.97	24.6	200	1.38	3	76	29	737	0.37	0.55
20018639	3/4	19.1	1.11	28.2	200	1.38	5	127	29	737	0.56	0.83
20018642	1	25.4	1.52	38.6	200	1.38	8	191	29	737	0.71	1.06
20018644	1¼	31.8	1.73	43.9	200	1.38	11	279	29	737	0.84	1.25
20018647	1½	38.1	2.13	54.1	200	1.38	14	356	29	737	1.24	1.85
20018650	2	50.8	2.69	68.3	200	1.38	18	457	29	737	1.71	2.54
20157471	3	76.2	3.67	93.2	200	1.38	35	889	29	737	2.52	3.75

Note: Refer to the Continental ContiTech Chemical Resistance Charts pages in Appendix B for specific chemical and temperature compatibility.

**Air & Multipurpose**  
General Purpose  
Heavy Duty  
Push-on

**Chemical Transfer**

Cleaning Equipment

**Food**  
Transfer  
Washdown

Marine

**Material Handling**  
Abrasives  
Bulk Transfer  
Cement & Concrete

Mining

**Petroleum**  
Aircraft Fueling  
Dispensing  
Dock  
Transfer

Spray

Steam

Vacuum

LPG Delivery

**Water**  
Discharge  
Suction & Discharge  
Washdown

Welding

Coupling Systems

Equipment

Appendix

# Orange Flexwing® Flosyn® Tube



**Air & Multipurpose**

- General Purpose
- Heavy Duty
- Push-on

**Chemical Transfer**

Cleaning Equipment

**Food**

- Transfer
- Washdown

Marine

**Material Handling**

- Abrasives
- Bulk Transfer
- Cement & Concrete

Mining

**Petroleum**

- Aircraft Fueling
- Dispensing
- Dock Transfer

Spray

Steam

Vacuum

LPG Delivery

**Water**

- Discharge
- Suction & Discharge
- Washdown

Welding

Coupling Systems

Equipment

Appendix

## Product Specifications

**Application**

A versatile chemical hose capable of handling a wide variety of acids, alcohols, salt solutions and petroleum-based products.

**Construction Tube**

Black Flosyn® synthetic rubber

**Cover**

Orange Chemivic™ synthetic rubber with white spiral brand (wrapped impression)

**Reinforcement**

Spiral-plied synthetic fabric with double wire helix

**Temperature Range**

-25°F to 250°F (-32°C to 121°C)

**Packaging**

100' exact length, coiled, polywrapped

**Branding (Spiral)**

Example: Continental ContiTech Orange Flexwing® with Flosyn® 150 psi WP

**Couplings**

Use Continental ContiTech Insta-Lock™ Cam & Groove Fittings with this product. See the Coupling Systems information pages at the back of the catalog.

**Non-Stock/Sizes**

Order in increments of 100'

**Order Codes**

541-063

### Orange Flexwing®

SAP #	ID	Nom. OD		Max. WP		Bend Radius		Vacuum HG		Weight		
		in.	mm	in.	mm	in.	mm	in.	mm	lb./ft.	kg/m	
20014912	1	25.4	1.44	36.6	150	1.03	4	89	29	737	0.61	0.91
20014913	1¼	31.8	1.73	43.9	150	1.03	4	102	29	737	0.79	1.18
20014915	1½	38.1	1.97	50.0	150	1.03	4	102	29	737	0.95	1.41
20014917	2	50.8	2.58	65.5	150	1.03	5	127	29	737	1.45	2.16
20014918	2½	63.5	3.08	78.2	150	1.03	6	152	29	737	1.77	2.63
20014919	3	76.2	3.59	91.2	150	1.03	7	178	29	737	2.26	3.36
20014921	4	101.6	4.69	119.1	150	1.03	10	254	29	737	3.31	4.93
20131037	6	152.4	6.81	173.0	150	1.03	30	762	29	737	6.29	9.36

Note: Refer to the Continental ContiTech Chemical Resistance Charts pages in Appendix B for specific chemical and temperature compatibility.



# Purple Flexwing®



## Product Specifications

### Application

A versatile hose developed to handle a wide range of chemicals, acids and alcohols in both suction and discharge service.

### Construction Tube

Black EPDM synthetic rubber

### Cover

Purple EPDM with yellow spiral brand (wrapped impression)

### Reinforcement

Spiral-plied synthetic fabric with double wire helix

### Temperature Range

-40°F to 221°F (-40°C to 104°C)

### Packaging

100' exact length, coiled, polywrapped

### Branding (Spiral)

Example: Continental ContiTech Purple Flexwing® with EPDM 150 psi Max WP

### Couplings

Use Continental ContiTech Insta-Lock™ Cam & Groove Fittings with this product. See the Coupling Systems information pages at the back of the catalog.

### Order Codes

546-805

## Purple Flexwing®

SAP #	ID		Nom. OD		Max. WP		Bend Radius		Vacuum HG		Weight	
	in.	mm	in.	mm	psi	MPa	in.	mm	in.	mm	lb./ft.	kg/m
20018743	1½	38.1	2.02	51.3	150	1.03	4	102	29	737	0.95	1.41
20018749	2	50.8	2.53	64.3	150	1.03	5	127	29	737	1.16	1.73
20018750	3	76.2	3.58	90.9	150	1.03	7	178	29	737	2.00	2.98
20018751	4	101.6	4.69	119.1	150	1.03	10	254	29	737	3.03	4.51

Note: Refer to the Continental ContiTech Chemical Resistance Charts pages in Appendix B for specific chemical and temperature compatibility.

**Air & Multipurpose**  
General Purpose  
Heavy Duty  
Push-on

Chemical Transfer

Cleaning Equipment

**Food**  
Transfer  
Washdown

Marine

**Material Handling**  
Abrasives  
Bulk Transfer  
Cement & Concrete

Mining

**Petroleum**  
Aircraft Fueling  
Dispensing  
Dock  
Transfer

Spray

Steam

Vacuum

LPG Delivery

**Water**  
Discharge  
Suction & Discharge  
Washdown

Welding

Coupling Systems

Equipment

Appendix

# Plicord® ExtremeFlex™ Brown



## Product Specifications

### Application

A high-tech, flexible and versatile chemical hose capable of handling a wide variety of acids, alcohols, salt solutions and petroleum-based products.

### Construction Tube

Black Chemrin® (CPE) synthetic rubber

### Cover

Corrugated Brown EPDM synthetic rubber with white spiral stripe

### Reinforcement

Spiral-plied synthetic fabric with double wire helix

### Temperature Range

-30°F to 275°F (-34°C to 135°C)

### Packaging

100' exact cut length, coiled, polywrapped

### Branding (Spiral)

Example: Continental ContiTech Plicord® ExtremeFlex™ Brown w/ Chemrin® 150 psi. Made In Canada

### Couplings

Use Continental ContiTech Insta-Lock™ Cam & Groove Fittings with the product. See the Coupling Systems information pages at the back of the catalog.

### Non-Stock/Sizes

400' minimum if not stocked.

### Order Codes

546-723

## Plicord® ExtremeFlex™ Brown

SAP #	ID	Nom. OD		Max. WP		Bend Radius		Vacuum HG		Weight		
		in.	mm	in.	mm	in.	mm	in.	mm	lb./ft.	kg/m	
20524365	1	25.30	1.42	36.00	150	1.03	1.50	38.10	29	737	0.50	0.75
20524366	1¼	32.00	1.63	41.50	150	1.03	2.00	50.80	29	737	0.57	0.85
20668438	1½	38.00	1.92	48.70	150	1.03	2.25	57.20	29	737	0.74	1.10
20524368	2	51.20	2.44	61.90	150	1.03	3.00	76.00	29	737	0.97	1.45
20524369	3	76.20	3.54	89.80	150	1.03	4.50	114.00	29	737	1.80	2.68
20524381	4	102.10	4.57	116.10	150	1.03	6.00	152.00	29	737	2.47	3.68



Air & Multipurpose

General Purpose

Heavy Duty

Push-on

Chemical Transfer

Cleaning Equipment

Food

Transfer

Washdown

Marine

Material Handling

Abrasives

Bulk Transfer

Cement & Concrete

Mining

Petroleum

Aircraft Fueling

Dispensing

Dock

Transfer

Spray

Steam

Vacuum

LPG Delivery

Water

Discharge

Suction & Discharge

Washdown

Welding

Coupling Systems

Equipment

Appendix

# Plicord® ExtremeFlex™ Purple



## Product Specifications

### Application

A high-tech, flexible and versatile chemical hose capable of handling a wide range of chemicals, acids and alcohols in both suction and discharge service.

### Construction Tube

Black EPDM synthetic rubber

### Cover

Corrugated Purple EPDM synthetic rubber with yellow spiral stripe

### Reinforcement

Spiral-plied synthetic fabric with double wire helix

### Temperature Range

-40°F to 221°F (-40°C to 104°C)

### Packaging

100' exact cut length, coiled, polywrapped

### Branding (Spiral)

Example: Continental ContiTech Plicord® ExtremeFlex™ Purple 150 psi. Made In Canada

### Couplings

Use Continental ContiTech Insta-Lock™ Cam & Groove Fittings with the product. See the Coupling Systems information pages at the back of the catalog.

### Non-Stock/Sizes

400' minimum if not stocked.

### Order Codes

546-721

## Plicord® ExtremeFlex™ Purple

SAP #	ID	Nom. OD		Max. WP		Bend Radius		Vacuum HG		Weight		
		in.	mm	in.	mm	in.	mm	in.	mm	lb./ft.	kg/m	
20524360	1½	38.00	1.92	48.70	150	1.03	2.25	57.20	29	737	0.73	1.09
20524361	2	51.20	2.44	61.90	150	1.03	3.00	76.00	29	737	0.95	1.42
20524362	3	76.10	3.54	89.80	150	1.03	4.50	114.00	29	737	1.76	2.62
20524363	4	102.10	4.57	116.10	150	1.03	6.00	152.00	29	737	2.41	3.59



Air & Multipurpose  
General Purpose  
Heavy Duty  
Push-on

Chemical Transfer

Cleaning Equipment

Food  
Transfer  
Washdown

Marine

Material Handling  
Abrasives  
Bulk Transfer  
Cement & Concrete

Mining

Petroleum  
Aircraft Fueling  
Dispensing  
Dock  
Transfer

Spray

Steam

Vacuum

LPG Delivery

Water  
Discharge  
Suction & Discharge  
Washdown

Welding

Coupling Systems

Equipment

Appendix

# Cleaning Equipment



**Air & Multipurpose**  
 General Purpose  
 Heavy Duty  
 Push-on

Chemical Transfer

**Cleaning Equipment**

**Food**  
 Transfer  
 Washdown

Marine

**Material Handling**  
 Abrasives  
 Bulk Transfer  
 Cement & Concrete

Mining

**Petroleum**  
 Aircraft Fueling  
 Dispensing  
 Dock  
 Transfer

Spray

Steam

Vacuum

LPG Delivery

**Water**  
 Discharge  
 Suction & Discharge  
 Washdown

Welding

Coupling Systems

Equipment

Appendix

	Page	Superior Abrasion Cover	Oil Resistance Cover	Microban Cover	Temp. Range*	Non-Marking*	Wire	Textile	Couple Assemblies
Fortress 300	87	Yes	Yes		-20°F to 200°F (-29°C to 93°C)	Yes		Yes	
Fortress 1000	88	Yes	Yes	Yes	-20°F to 200°F (-29°C to 93°C)	Yes		Yes	Yes
Fortress 3000	89	Yes	Yes	Yes	-20°F to 250°F (-29°C to 121°C)	Yes	Yes		Yes
Galvanator 3000	63	Yes	Yes		-20°F to 250°F (-29°C to 121°C)	Yes	Yes		Yes
Gauntlet 1500	60	Yes	Yes		-20°F to 200°F (-29°C to 93°C)	Yes		Yes	Yes
Gauntlet 3000	61	Yes	Yes		-20°F to 250°F (-29°C to 121°C)	Yes	Yes		Yes
Gauntlet 4500	62	Yes	Yes		-20°F to 250°F (-29°C to 121°C)	Yes	Yes		Yes
Neptune 1500	54				-20°F to 200°F (-29°C to 93°C)	Yes		Yes	Yes
Neptune 3000	55				-20°F to 250°F (-29°C to 121°C)	Yes	Yes		Yes
Neptune 4001-R	56				-20°F to 250°F (-29°C to 121°C)	Yes	Yes		Yes
Neptune 4500	57				-20°F to 250°F (-29°C to 121°C)	Yes	Yes		Yes
Neptune 6000	58				-20°F to 250°F (-29°C to 121°C)	Yes	Yes		Yes
SpiraFlow	53				-20°F to 250°F (-29°C to 121°C)	Yes	Yes		Yes
Whitewater	59				-20°F to 250°F** (-29°C to 121°C)	Yes	Yes		Yes

\*Non-black colors

\*\*Hot water for Steam Cleaner Service at 325°F (163°C) and 350 psi

# SpiraFlow®



## Product Specifications

### Application

Designed specifically for the pressure washer industry. A pressure washer hose that reduces damming which can cause clean spots. Ideal for surface cleaning applications such as parking decks and lots; beef, dairy and poultry operations; gas stations; garages; and auto mechanic shops.

### Construction Tube

Black Nitrile synthetic rubber

### Cover

Black, Blue or Gray oil-resistant synthetic rubber, RMA Class B (Medium/High Oil Resistance)

### Reinforcement

Braided (1) steel wire

### Temperature Range

-20°F to 250°F (-29°C to 121°C)

### Packaging

500' reels, maximum 3 pieces, 50' increments, coupled lengths available.

### Branding

Not branded

### Couplings

Contact fitting manufacturer for proper fitting recommendations and coupling procedure.

### Order Codes

539-185 (black)  
539-186 (blue)  
539-187 (gray)

## SpiraFlow®

SAP #			ID		Nom. OD		Max. WP		Weight	
Black	Blue	Gray	in.	mm	in.	mm	psi	MPa	lb./ft.	kg/m
20342127	20342128	20342221	3/8	9.53	0.78	19.69	4000	27.58	0.30	0.44

**Air & Multipurpose**  
General Purpose  
Heavy Duty  
Push-on

Chemical Transfer

Cleaning Equipment

**Food**  
Transfer  
Washdown

Marine

**Material Handling**  
Abrasives  
Bulk Transfer  
Cement & Concrete

Mining

**Petroleum**  
Aircraft Fueling  
Dispensing  
Dock  
Transfer

Spray

Steam

Vacuum

LPG Delivery

**Water**  
Discharge  
Suction & Discharge  
Washdown

Welding

Coupling Systems

Equipment

Appendix

# Neptune™ 1500



## Product Specifications

### Application

For pressure washer equipment, agricultural sprayers and high-pressure air lines.

### Construction Tube

Nitrile synthetic rubber

### Cover

Blue, Gray, Red, Yellow or Black oil-resistant synthetic rubber, RMA Class B (Medium Oil Resistance)

### Reinforcement

Braided (1) synthetic yarn up through 1/2". Braided (2) synthetic yarn for 3/4"

### Temperature Range

-20°F to 200°F (-29°C to 93°C)

### Packaging

1/4"-5/16" - 550' to 750' reels, max 8 pieces, 25' minimum  
 3/8"-500' reels, max 3 pieces, 50' increments  
 1/2"-3/4" - 450' to 550' reels, max 5 pieces, 10' minimum

### Branding

Example: Continental ContiTech Neptune™ 1500 3/8" 1500 psi WP. Made in U.S.A.

### Couplings

Contact fitting manufacturer for proper fitting recommendation and coupling procedure. Coupled lengths with MxMS fittings and Kink Guards available.

### Order Codes

536-374 (blue)  
 536-387 (gray)  
 536-388 (black)  
 536-490 (yellow)

## Neptune™ 1500

SAP #				ID		Nom. OD		Max. WP		Weight	
Blue	Gray	Black	Yellow	in.	mm	in.	mm	psi	MPa	lb./ft.	kg/m
20449806	20023093	20023102		1/4	6.4	0.59	15.0	1500	10.34	0.11	0.16
		20023106		5/16	7.9	0.69	17.5	1500	10.34	0.15	0.22
20142362	20023096	20023109	20029580	3/8	9.5	0.75	19.1	1500	10.34	0.18	0.27
20590578	20023099	20023116		1/2	12.7	0.84	21.3	1200	8.27	0.19	0.28

Note: Not recommended for steam service.

Neptune™ 1500 in 1/2" ID size is rated at a working pressure rating of 1200 psi. All other sizes listed above are rated at a working pressure of 1500 psi.

Air & Multipurpose

General Purpose

Heavy Duty

Push-on

Chemical Transfer

Cleaning Equipment

Food Transfer Washdown

Marine

Material Handling

Abrasives

Bulk Transfer

Cement & Concrete

Mining

Petroleum

Aircraft Fueling

Dispensing

Dock Transfer

Spray

Steam

Vacuum

LPG Delivery

Water

Discharge

Suction & Discharge

Washdown

Welding

Coupling Systems

Equipment

Appendix

# Neptune™ 3000



## Product Specifications

### Application

For use on pressure washer machines with working pressures up to 3000 psi.

### Construction Tube

Nitrile synthetic rubber

### Cover

Black, Blue, Yellow or Gray oil-resistant synthetic rubber, RMA Class B (Medium Oil Resistance)

### Reinforcement

Braided (1) steel wire

### Temperature Range

-20°F to 250°F (-29°C to 121°C)

### Packaging

500' reel, maximum 3 pieces, 50' increments

### Branding

Example: Continental ContiTech Neptune™ 3000 3/8" 3000 psi WP. Made in U.S.A.

### Couplings

Use Continental ContiTech pressure washing fittings with this product. See the Coupling Systems information pages at the back of the catalog for available sizes. Refer to the Continental ContiTech Hose Assembly Manual for crimp procedures. Coupled lengths with MxMS fittings and Kink Guards available.

### Order Codes

539-085 (black)  
 539-089 (blue)  
 539-104 (yellow)  
 539-090 (gray)

## Neptune™ 3000

SAP #				ID		Nom. OD		Max. WP		Weight	
Black	Blue	Yellow	Gray	in.	mm	in.	mm	psi	MPa	lb./ft.	kg/m
20023506	20023623	20155405	20023720	1/4	6.4	0.53	13.5	3000	20.69	0.15	0.22
20023581	20023638	20023949	20023726	3/8	9.5	0.69	17.5	3000	20.69	0.24	0.36
20023613	20023670	20023959	20216243	1/2	12.7	0.82	20.8	3000	20.69	0.32	0.48

Note: Not recommended for steam service.

**Air & Multipurpose**  
 General Purpose  
 Heavy Duty  
 Push-on

Chemical Transfer

Cleaning Equipment

**Food**  
 Transfer  
 Washdown

Marine

**Material Handling**  
 Abrasives  
 Bulk Transfer  
 Cement & Concrete

Mining

**Petroleum**  
 Aircraft Fueling  
 Dispensing  
 Dock  
 Transfer

Spray

Steam

Vacuum

LPG Delivery

**Water**  
 Discharge  
 Suction & Discharge  
 Washdown

Welding

Coupling Systems

Equipment

Appendix

# Neptune™ 4001-R



## Product Specifications

### Application

For high-pressure washer equipment with working pressures up to 4000 psi.

### Construction Tube

Nitrile synthetic rubber

### Cover

Black, Yellow, Blue or Gray oil resistant synthetic rubber, RMA Class B (Medium Oil Resistance)

### Reinforcement

Braided (1) steel wire

### Temperature Range

-20°F to 250°F (-29°C to 121°C)

### Packaging

500' reel, maximum 3 pieces, 50' increments

### Branding

Example: Continental ContiTech Neptune™ 4001-R 3/8" 4000 psi WP. Made in U.S.A.

### Couplings

Use Continental ContiTech pressure washing fittings with this product. See the Coupling Systems information pages at the back of the catalog for available sizes. Refer to the Continental ContiTech Hose Assembly Manual for crimp procedures. Coupled lengths with MxMS fittings and Kink Guards available.

### Order Codes

- 539-261 (black)
- 539-266 (yellow)
- 539-265 (blue)
- 539-262 (gray)
- 539-111 (red)

## Neptune™ 4001-R

SAP #				ID		Nom. OD		Max. WP		Weight	
Black	Yellow	Blue	Gray	in.	mm	in.	mm	psi	MPa	lb./ft.	kg/m
20129270	20135601	20119564	20527217	3/8	9.5	0.69	17.5	4000	27.58	0.25	0.37

Note: Not recommended for steam service.

**Air & Multipurpose**

- General Purpose
- Heavy Duty
- Push-on

Chemical Transfer

Cleaning Equipment

- Food Transfer Washdown

Marine

**Material Handling**

- Abrasives
- Bulk Transfer
- Cement & Concrete

Mining

**Petroleum**

- Aircraft Fueling
- Dispensing
- Dock Transfer

Spray

Steam

Vacuum

LPG Delivery

**Water**

- Discharge
- Suction & Discharge
- Washdown

Welding

Coupling Systems

Equipment

Appendix



# Neptune™ 4500



## Product Specifications

### Application

For use on pressure washer machines with working pressures up to 4500 psi.

### Construction Tube

Nitrile synthetic rubber

### Cover

Black or Blue oil-resistant synthetic rubber, RMA Class B (Medium Oil Resistance)

### Reinforcement

Braided (2) steel wires

### Temperature Range

-20°F to 250°F (-29°C to 121°C)

### Packaging

1/4"-3/8" - 500' reels, maximum 3 pieces, minimum of 50' lengths  
 1/2" - 500' reels, maximum 3 pieces, minimum of 50' lengths

### Branding

Example: Continental ContiTech Neptune™ 4500 3/8" 4500 psi WP. Made in U.S.A.

### Couplings

Use Continental ContiTech pressure washing fittings with this product. See the Coupling Systems information pages at the back of the catalog for available sizes. Refer to the Continental ContiTech Hose Assembly Manual for crimp procedures. Coupled lengths with MxMS fittings and Kink Guards available.

### Order Codes

539-091 (black)  
 539-124 (blue)

## Neptune™ 4500

SAP #		ID		Nom. OD		Max. WP		Weight	
Black	Blue	in.	mm	in.	mm	psi	MPa	lb./ft.	kg/m
	20069357	1/4	6.4	0.54	13.7	4500	31.03	0.20	0.30
20023741	20024005	3/8	9.5	0.69	17.5	4500	31.03	0.28	0.42
20023757		1/2	12.7	0.82	20.8	4500	31.03	0.35	0.52

Note: Not recommended for steam service.

**Air & Multipurpose**  
 General Purpose  
 Heavy Duty  
 Push-on

Chemical Transfer

Cleaning Equipment

**Food**  
 Transfer  
 Washdown

Marine

**Material Handling**  
 Abrasives  
 Bulk Transfer  
 Cement & Concrete

Mining

**Petroleum**  
 Aircraft Fueling  
 Dispensing  
 Dock  
 Transfer

Spray

Steam

Vacuum

LPG Delivery

**Water**  
 Discharge  
 Suction & Discharge  
 Washdown

Welding

Coupling Systems

Equipment

Appendix

# Neptune™ 6000



## Product Specifications

### Application

For use on pressure washer machines with working pressures up to 6000 psi.

### Construction Tube

Nitrile synthetic rubber

### Cover

Black oil resistant synthetic rubber, RMA Class B (Medium Oil Resistance)

### Reinforcement

Braided (2) steel wires

### Temperature Range

-20°F to 250°F (-29°C to 121°C)

### Packaging

500' reels, maximum 3 piece, 50' increments, coupled lengths available

### Branding

Example: Continental ContiTech Neptune™ 6000 3/8" 6000 psi WP. Made in U.S.A.

### Couplings

Contact fitting manufacturer for proper fitting recommendation and coupling procedure.

### Order Codes

539-149 (black)

539-148 (gray)

## Neptune™ 6000

SAP #		ID		Nom. OD		Max. WP		Weight	
Black	Gray	in.	mm	in.	mm	psi	MPa	lb./ft.	kg/m
20046112	20551519	3/8	9.5	0.69	17.5	6000	41.37	0.30	0.45

Note: Not recommended for steam service.

**Air & Multipurpose**

General Purpose

Heavy Duty

Push-on

Chemical Transfer

**Cleaning Equipment**

**Food**

Transfer

Washdown

Marine

**Material Handling**

Abrasives

Bulk Transfer

Cement & Concrete

Mining

**Petroleum**

Aircraft Fueling

Dispensing

Dock

Transfer

Spray

Steam

Vacuum

LPG Delivery

**Water**

Discharge

Suction & Discharge

Washdown

Welding

Coupling Systems

Equipment

Appendix

# Whitewater®



## Product Specifications

### Application

For use on either steam cleaner machines or combination steam cleaner/pressure washer machines.

### Construction Tube

Pyrosyn® synthetic rubber

### Cover

Black and Red Hysunite™ synthetic rubber, RMA Class B (Medium Oil Resistance)

### Reinforcement

Braided (1) steel wire

### Temperature Range

Handles hot water at 325°F (163°C) and 350 psi for Steam Cleaning Service, handles hot water at 250°F (121°C) and 3000 psi (2500 psi on 1/2") for Pressure Washer Service

### Packaging

500' reel, maximum 3 pieces, 50' increments coupled lengths available

### Branding

Example: Continental ContiTech 3/8" Whitewater® Pressure Washer 3000 psi/250°F (121°C) Steam Cleaner 350 psi/325°F (163°C). Made in U.S.A.

### Couplings

Contact fitting manufacturer for proper fitting recommendation and coupling procedure.

### Order Codes

539-095 (black)  
539-110 (red)

### Whitewater® - Steam Cleaner Service - up to 325°F (163°C)

SAP #		Nom. ID		Nom. OD		Max. WP		Weight	
Black	Red	in.	mm	in.	mm	psi	MPa	lb./ft.	kg/m
20023806	20023984	3/8	9.50	0.69	17.50	350	2.40	0.23	0.34
20023820	20023987	1/2	12.70	0.83	21.20	350	2.40	0.31	0.46

### Whitewater® - Pressure Washer Service - up to 250°F (121°C)

SAP #		Nom. ID		Nom. OD		Max. WP		Weight	
Black	Red	in.	mm	in.	mm	psi	MPa	lb./ft.	kg/m
20023806	20023984	3/8	9.50	0.69	17.50	3,000	20.6	0.23	0.34
20023820	20023987	1/2	12.70	0.83	21.20	2,500	16.9	0.31	0.46

Note: Not recommended for steam service.

**Air & Multipurpose**  
General Purpose  
Heavy Duty  
Push-on

Chemical Transfer

Cleaning Equipment

**Food**  
Transfer  
Washdown

Marine

**Material Handling**  
Abrasives  
Bulk Transfer  
Cement & Concrete

Mining

**Petroleum**  
Aircraft Fueling  
Dispensing  
Dock  
Transfer

Spray

Steam

Vacuum

LPG Delivery

**Water**  
Discharge  
Suction & Discharge  
Washdown

Welding

Coupling Systems

Equipment

Appendix

# Gauntlet® 1500



## Product Specifications

### Application

Gauntlet® 1500 is for pressure washer equipment with working pressures up to 1500 psi. Its super abrasion-resistant cover provides maximum protection against adverse effects of oil and animal fats.

### Construction Tube

Nitrile synthetic rubber

### Cover

Black or Yellow oil-resistant Carbryn™ synthetic rubber, RMA Class A (High Oil Resistance)

### Reinforcement

Braided (1) synthetic yarn up through 1/2". Braided (2) synthetic yarn for 3/4"

### Temperature Range

-20°F to 200°F (-29°C to 93°C)

### Packaging

500' reel, maximum 3 pieces, 50' increments

### Branding

Example: Continental ContiTech Gauntlet® 1500 3/8" 1500 psi. Made in U.S.A.

### Couplings

Contact fitting manufacturer for proper fitting recommendation and coupling procedure. Coupled lengths with MxMS fittings and Kink Guards available.

### Order Codes

536-480 (black)  
536-474 (yellow)  
536-574 (red)

## Gauntlet® 1500

SAP #			ID		Nom. OD		Max. WP		Weight	
Black	Yellow	Red	in.	mm	in.	mm	psi	MPa	lb./ft.	kg/m
20023338	20045137		1/4	6.4	0.59	15.0	1500	10.34	0.11	0.16
20023339	20023331		3/8	9.5	0.75	19.1	1500	10.34	0.18	0.27
20023341	20023333	20115073	1/2	12.7	0.84	21.3	1200	8.27	0.18	0.27

Note: Not recommended for steam service.

Gauntlet® 1500 in the 1/2" ID is rated at a working pressure of 1200 psi. All other sizes listed above are rated at a working pressure of 1500 psi.

**Air & Multipurpose**

- General Purpose
- Heavy Duty
- Push-on

Chemical Transfer

Cleaning Equipment

- Food Transfer Washdown

Marine

**Material Handling**

- Abrasives
- Bulk Transfer
- Cement & Concrete

Mining

**Petroleum**

- Aircraft Fueling
- Dispensing
- Dock Transfer

Spray

Steam

Vacuum

LPG Delivery

**Water**

- Discharge
- Suction & Discharge
- Washdown

Welding

Coupling Systems

Equipment

Appendix

# Gauntlet® 3000



## Product Specifications

### Application

For use on pressure washer machines with working pressures up to 3000 psi. Its super abrasion-resistant cover provides maximum protection against adverse effects of oil and animal fats.

### Construction Tube

Nitrile synthetic rubber

### Cover

Black or Yellow oil-resistant Carbryn™ synthetic rubber, RMA Class A (High Oil Resistance)

### Reinforcement

Braided (1) steel wire

### Temperature Range

-20°F to 250°F (-29°C to 121°C)

### Packaging

500' reels, maximum 3 pieces, 50' increments

### Branding

Example: Continental ContiTech Gauntlet® 3000 3/8" 3000 psi. Made in U.S.A.

### Couplings

Use Continental ContiTech pressure washing fittings with this product. See the Coupling Systems information pages at the back of the catalog for available sizes. Refer to the Continental ContiTech Hose Assembly Manual for crimp procedures. Coupled lengths with MxMS fittings and Kink Guards available.

### Order Codes

539-099 (black)  
539-100 (yellow)

## Gauntlet® 3000

SAP #		ID		Nom. OD		Max. WP		Weight	
Black	Yellow	in.	mm	in.	mm	psi	MPa	lb./ft.	kg/m
20023887	20023890	3/8	9.5	0.69	17.5	3000	20.69	0.24	0.36
20023889	20023894	1/2	12.7	0.82	20.8	3000	20.69	0.32	0.48

Note: Not recommended for steam service.

**Air & Multipurpose**  
General Purpose  
Heavy Duty  
Push-on

Chemical Transfer

Cleaning Equipment

**Food**  
Transfer  
Washdown

Marine

**Material Handling**  
Abrasives  
Bulk Transfer  
Cement & Concrete

Mining

**Petroleum**  
Aircraft Fueling  
Dispensing  
Dock  
Transfer

Spray

Steam

Vacuum

LPG Delivery

**Water**  
Discharge  
Suction & Discharge  
Washdown

Welding

Coupling Systems

Equipment

Appendix

# Gauntlet® 4500



**Air & Multipurpose**  
 General Purpose  
 Heavy Duty  
 Push-on

Chemical Transfer

Cleaning Equipment

**Food**  
 Transfer  
 Washdown

Marine

**Material Handling**  
 Abrasives  
 Bulk Transfer  
 Cement & Concrete

Mining

**Petroleum**  
 Aircraft Fueling  
 Dispensing  
 Dock  
 Transfer

Spray

Steam

Vacuum

LPG Delivery

**Water**  
 Discharge  
 Suction & Discharge  
 Washdown

Welding

Coupling Systems

Equipment

Appendix

## Product Specifications

### Application

For use on pressure washer machines with working pressures up to 4500 psi. Its super abrasion-resistant cover provides maximum protection against adverse effects of oil and animal fats.

### Construction Tube

Nitrile synthetic rubber

### Cover

Black or Yellow oil-resistant Carbryn™ synthetic rubber, RMA Class A (High Oil Resistance)

### Reinforcement

Braided (2) steel wires

### Temperature Range

-20°F to 250°F (-29°C to 121°C)

### Packaging

1/4"-3/8" - 500' reels, maximum 3 pieces, minimum of 50' lengths, coupled lengths available

1/2" - 500' reels, maximum 3 pieces, minimum of 50' lengths, coupled lengths available

### Branding

Example: Continental ContiTech Gauntlet® 4500 3/8" 4500 psi WP. Made in U.S.A.

### Couplings

Use Continental ContiTech pressure washing fittings with this product. See the Coupling Systems information pages at the back of the catalog for available sizes. Refer to the Continental ContiTech Hose Assembly Manual for crimp procedures. Coupled lengths with MxMS fittings and Kink Guards available.

### Order Codes

539-122 (black)  
 539-120 (yellow)

## Gauntlet® 4500

SAP #	ID		Nom. OD		Max. WP		Weight			
	Black	Yellow	in.	mm	in.	mm	psi	MPa	lb./ft.	kg/m
20331250			1/4	6.4	0.54	13.7	4500	31.03	0.20	0.30
20220625	20024000		3/8	9.5	0.69	17.5	4500	31.03	0.27	0.40
20048788	20325124		1/2	12.7	0.82	20.8	4500	31.03	0.34	0.51

Note: Not recommended for steam service.

# Galvanator® 3000



## Product Specifications

### Application

For pressure washer equipment. Its rust-resistant reinforcement and superior abrasion-resistant cover provide maximum protection against adverse effects of water, oil and animal fats.

### Construction Tube

Nitrile synthetic rubber

### Cover

Yellow or Black Carbryn™ synthetic rubber (wrapped finish), ORS, RMA Class A (High Oil Resistance)

### Reinforcement

Braided (2) steel wires

### Temperature Range

-20°F to 250°F (-29°C to 121°C)

### Packaging

500' reels, maximum 3 pieces, 50' increments

### Branding

Example: Galvanator® 3000 3/8" (9.5mm) 3000 psi (20.7 MPa). Made in U.S.A.

### Couplings

Contact fitting manufacturer for proper fitting recommendation and coupling procedure. Coupled lengths with MxMS fittings and Kink Guards available.

### Order Codes

539-200 (yellow)  
539-201 (black)

## Galvanator® 3000

SAP #		ID		Nom. OD		Max. WP		Bend Radius		Weight	
Yellow	Black	in.	mm	in.	mm	psi	MPa	in.	mm	lb./ft.	kg/m
20024095	20024109	3/8	9.5	6.9	17.5	3000	20.69	2.0	64	0.26	0.39
20024100	20024110	1/2	12.7	0.82	20.8	3000	20.69	3.5	89	0.31	0.49

Note: Not recommended for steam service.

**Air & Multipurpose**  
General Purpose  
Heavy Duty  
Push-on

Chemical Transfer

Cleaning Equipment

**Food**  
Transfer  
Washdown

Marine

**Material Handling**  
Abrasives  
Bulk Transfer  
Cement & Concrete

Mining

**Petroleum**  
Aircraft Fueling  
Dispensing  
Dock  
Transfer

Spray

Steam

Vacuum

LPG Delivery

**Water**  
Discharge  
Suction & Discharge  
Washdown

Welding

Coupling Systems

Equipment

Appendix

# Food Transfer



**Air & Multipurpose**  
 General Purpose  
 Heavy Duty  
 Push-on

Chemical Transfer

Cleaning Equipment

**Food**  
 Transfer  
 Washdown

Marine

**Material Handling**  
 Abrasives  
 Bulk Transfer  
 Cement & Concrete

Mining

**Petroleum**  
 Aircraft Fueling  
 Dispensing  
 Dock  
 Transfer

Spray

Steam

Vacuum

LPG Delivery

**Water**  
 Discharge  
 Suction & Discharge  
 Washdown

Welding

Coupling Systems

Equipment

Appendix

	Page	Dry or Liquid	Temp. Range	Beer/ Wine	Dairy	Thermo- Clear plastic	3-A, FDA, USDA	Static NSF 61	Helical Wire
Exstatic	68	Dry	-25°F to 180°F (-32°C to 82°C)				FDA, USDA		Yes
Gray Flextra LT	67	Liquid	-25°F to 212°F (-32°C to 100°C)	Yes	Yes		Yes		Yes
Harvest	69	Dry	-25°F to 180°F (-32°C to 82°C)				Yes		Yes
Nutriflex S&D	71	Both	-15°F to 158°F (-26°C to 70°C)	Yes	Yes	Yes	Yes	Yes	
Nutrilex Static Wire	72	Dry	-15°F to 158°F (-26°C to 70°C)		Yes	Yes	Yes	Yes	Yes
Nutriflo S&D	70	Both	-15°F to 158°F (-26°C to 70°C)	Yes	Yes	Yes	Yes	Yes	
Plicord Blue Flour	73	Dry	-40°F to 180°F (-40°C to 82°C)				Yes	FDA	Yes
Plicord Brewline	74	Liquid	-40°F to 220°F (-40°C to 104°C)	Yes			Yes	Yes	
Plicord Extremeflex Beverage Gray	80	Liquid	-30°F to 220°F (-34°C to 104°C)	Yes	Yes		Yes	Yes	Yes
Plicord Extremeflex Beverage Red with EZ Clean Cover	81	Liquid	-30°F to 220°F (-34°C to 104°C)	Yes	Yes		Yes	Yes	Yes
Plicord Extremeflex Food Grade	75	Dry	-25°F to 212°F (-32°C to 100°C)		Yes		Yes	Yes	Yes
Plicord Gray Food	66	Liquid	-25°F to 230°F (-32°C to 110°C)		Yes		Yes	Yes	Yes
Plicord Wineline	76	Liquid	-40°F to 220°F (-40°C to 104°C)	Yes			Yes	Yes	
Pliovic FG (FDA-3A)	77	Both	-10°F to 158°F (-23°C to 70°C)	Yes	Yes	Yes	Yes	Yes	
Potable Water	78	Liquid	-40°F to 180°F (-40°C to 82°C)				Yes	Yes	
Spirathane PT	122	Dry	0°F to 158°F (-18°C to 70°C)			Yes	Yes	FDA	Yes
Tan Flexwing	82	Liquid	-40°F to 180°F (-40°C to 82°C)				Yes	Yes	Yes
Tan Flextra	83	Dry	-40°F to 180°F (-40°C to 82°C)						Yes
Tan Softwall	84								
Vintner	79	Liquid	-30°F to 220°F (-34°C to 104°C)	Yes			Yes	Yes	
White Flexwing	65	Both	-25°F to 230°F (-32°C to 110°C)		Yes		Yes	Yes	Yes



# White Flexwing®



## Product Specifications

### Application

A highly flexible hose for gravity flow, pressure, or suction service transferring oily and non-oily edibles from tank truck and in-plant service.

### Construction Tube

White Chemivic™ synthetic rubber (FDA/USDA compliant and conforms to 3-A Sanitary Standard 18-03)

### Cover

White Chemivic™ synthetic rubber (wrapped impression)

### Reinforcement

Spiral-plied synthetic fabric with galvanized wire helix

### Temperature Range

-25°F to 230°F (-32°C to 110°C)

### Packaging

100' length, coiled, polywrapped

### Branding (Spiral)

Example: Continental ContiTech White Flexwing® 150 psi WP; FDA, 3-A, and USDA

### Couplings

Contact fitting manufacturer for proper fitting recommendations and coupling procedure.

### Order Codes

549-151

### White Flexwing®

SAP #	ID		Nom. OD		Max. WP		Bend Radius		Vacuum HG		Weight	
	in.	mm	in.	mm	psi	MPa	in.	mm	in.	mm	lb./ft.	kg/m
20019284	3/4	19.1	1.20	30.5	150	1.03	2	51	29	737	0.47	0.70
20019286	1	25.4	1.44	36.6	150	1.03	3	76	29	737	0.57	0.85
20019287	1¼	31.8	1.70	43.2	150	1.03	4	102	29	737	0.69	1.03
20019289	1½	38.1	1.97	50.0	150	1.03	4	102	29	737	0.86	1.28
20019292	2	50.8	2.53	64.3	150	1.03	5	114	29	737	1.23	1.83
20019296	2½	63.5	3.10	78.7	150	1.03	6	146	29	737	1.81	2.69
20019297	3	76.2	3.60	91.4	150	1.03	7	178	29	737	2.16	3.21
20019301	4	101.6	4.64	117.9	150	1.03	10	254	29	737	3.05	4.54

For Continental ContiTech food hose compliance information, see Appendix C.

**Air & Multipurpose**  
General Purpose  
Heavy Duty  
Push-on

Chemical Transfer

Cleaning Equipment

**Food**  
Transfer  
Washdown

Marine

**Material Handling**  
Abrasives  
Bulk Transfer  
Cement & Concrete

Mining

**Petroleum**  
Aircraft Fueling  
Dispensing  
Dock  
Transfer

Spray

Steam

Vacuum

LPG Delivery

**Water**  
Discharge  
Suction & Discharge  
Washdown

Welding

Coupling Systems

Equipment

Appendix

# Plicord® Gray Food



## Product Specifications

### Application

A flexible hose for gravity flow, pressure, or suction service transferring edibles from tank truck and in-plant service.

### Branding (Spiral)

Example: Continental ContiTech Plicord® Gray Food; FDA, 3-A, and USDA 150 psi

### Construction Tube

White Chemivic™ synthetic rubber (FDA/USDA compliant and conforms to 3-A Sanitary Standard 18-03)

### Couplings

Contact fitting manufacturer for proper fitting recommendations and coupling procedure.

### Cover

Gray Chemivic™ synthetic rubber (wrapped impression)

### Order Codes

549-834

### Reinforcement

Spiral-plied synthetic fabric with galvanized wire helix

### Temperature Range

-25°F to 230°F (-32°C to 110°C)

### Packaging

100' length, coiled, polywrapped

## Plicord® Gray Food

SAP #	ID	Nom. OD		Max. WP		Bend Radius		Vacuum HG		Weight		
Gray	in.	mm	in.	mm	psi	MPa	in.	mm	in.	mm	lb./ft.	kg/m
20020211	1	25.4	1.45	36.7	150	1.03	3	75	29	737	0.58	0.86
20020212	1½	38.1	1.97	50.0	150	1.03	4	102	29	737	0.85	1.26
20020214	2	50.8	2.59	65.8	150	1.03	5	114	29	737	1.42	2.11
20020216	2½	63.5	3.09	78.5	150	1.03	6	152	29	737	1.77	2.63
20020217	3	76.2	3.59	91.2	150	1.03	7	178	29	737	2.10	3.13
20020219	4	101.6	4.68	118.9	150	1.03	10	254	29	737	3.19	4.75

For Continental ContiTech food hose compliance information, see Appendix C.

Air & Multipurpose

General Purpose

Heavy Duty

Push-on

Chemical Transfer

Cleaning Equipment

**Food**

Transfer

Washdown

Marine

**Material Handling**

Abrasives

Bulk Transfer

Cement & Concrete

Mining

**Petroleum**

Aircraft Fueling

Dispensing

Dock

Transfer

Spray

Steam

Vacuum

LPG Delivery

**Water**

Discharge

Suction & Discharge

Washdown

Welding

Coupling Systems

Equipment

Appendix

# Gray Flextra® LT



## Product Specifications

### Application

A lightweight, highly flexible hose used for transferring edibles in gravity flow, pressure or suction service. Larger ID sizes (5" and 6") applicable as "must" hoses in the wine industry.

### Construction Tube

White Chemivic™ (complies with FDA, USDA and 3-A)

### Cover

Gray Chemivic™ (corrugated, wrapped impression)

### Reinforcement

Synthetic textile fabric plies and two galvanized wire helix

### Temperature Range

-25°F to 212°F (-32°C to 100°C)

### Packaging

Coiled-polyethylene wrapped/bagel pack

### Branding (Spiral)

Example: Continental ContiTech Gray Flextra® LT 150 psi WP; FDA, 3-A and USDA

### Couplings

Contact fitting manufacturer for proper fitting recommendation and coupling procedure.

### Order Codes

549-357

## Gray Flextra® LT

SAP #	ID		Nom. OD		Max. WP		Bend Radius		Vacuum HG		Weight	
	in.	mm	in.	mm	psi	MPa	in.	mm	in.	mm	lb./ft.	kg/m
20155751	1½	38.1	1.92	48.8	150	1.03	3	64	29	737	0.77	1.15
20134015	2	50.8	2.44	62.0	150	1.03	3	76	29	737	1.00	1.49
20313545	2½	63.5	3.00	76.2	150	1.03	5	127	29	737	1.46	2.17
20070367	3	76.2	3.51	89.2	150	1.03	6	140	29	737	1.95	2.90
20131039	4	101.6	4.55	115.6	150	1.03	7	191	29	737	2.59	3.85
20129912	5	127.0	5.66	143.8	150	1.03	12	305	29	737	3.84	5.71
20129913	6	152.4	6.66	169.2	150	1.03	17	432	29	737	4.55	6.77

For Continental ContiTech food hose compliance information, see Appendix C.

**Air & Multipurpose**  
General Purpose  
Heavy Duty  
Push-on

Chemical Transfer

Cleaning Equipment

**Food**  
Transfer  
Washdown

Marine

**Material Handling**  
Abrasives  
Bulk Transfer  
Cement & Concrete

Mining

**Petroleum**  
Aircraft Fueling  
Dispensing  
Dock  
Transfer

Spray

Steam

Vacuum

LPG Delivery

**Water**  
Discharge  
Suction & Discharge  
Washdown

Welding

Coupling Systems

Equipment

Appendix

# Exstatic®



## Product Specifications

### Application

Exstatic® hose is for tank truck and/or in-plant transfer of dry, bulk foodstuffs where there is a potential for electrical static build-up.

### Construction Tube

FDA UHMWPE (static dissipating/static conductive) has FDA/USDA compliant materials

### Cover

Blue SBR synthetic rubber (corrugated) / spiral transfer brand (wrapped impression)

### Reinforcement

Spiral-plied synthetic fabric with double wire helix

### Temperature Range

-25°F to 180°F (-32°C to 82°C)

### Packaging

100' length, coiled, polywrapped

### Branding (Spiral)

Example: Continental ContiTech Plicord® Exstatic® FDA Dry Material handling 150 psi

### Couplings

Contact fitting manufacturer for proper fitting recommendation and coupling procedure. Use Continental ContiTech Insta-Lock™ Cam & Groove Fittings with this product. See the Couplings Systems information pages at the back of the catalog.

### Order Codes

549-608

## Exstatic®

SAP #	ID	Nom. OD		Max. WP		Bend Radius		Vacuum HG		Weight		
		in.	mm	in.	mm	in.	mm	in.	mm	lb./ft.	kg/m	
20019899	2	50.8	2.50	63.5	150	1.03	8	203	29	737	1.07	1.59
20019901	3	76.2	3.56	90.4	150	1.03	12	305	29	737	1.83	2.72
20019904	4	101.6	4.59	116.6	150	1.03	16	406	29	737	2.49	3.71
20019905	5	127.0	5.67	144.0	150	1.03	20	508	29	737	3.69	5.49

For Continental ContiTech food hose compliance information, see Appendix C.

Air & Multipurpose

General Purpose

Heavy Duty

Push-on

Chemical Transfer

Cleaning Equipment

**Food**

Transfer

Washdown

Marine

**Material Handling**

Abrasives

Bulk Transfer

Cement & Concrete

Mining

**Petroleum**

Aircraft Fueling

Dispensing

Dock

Transfer

Spray

Steam

Vacuum

LPG Delivery

**Water**

Discharge

Suction & Discharge

Washdown

Welding

Coupling Systems

Equipment

Appendix

# Harvest®



## Product Specifications

### Application

For tank truck and/or in-plant applications for the transfer of dry, non-oily bulk foodstuffs.

### Construction Tube

FDA, White Pureten™ (natural rubber) (FDA/USDA compliant and conforms to 3-A Sanitary Standard 18-03)

### Cover

Gray EPDM synthetic rubber (corrugated) / orange branding tape (wrapped impression)

### Reinforcement

Spiral-plied synthetic fabric with double galvanized wire helix

### Temperature Range

-25°F to 180°F (-32°C to 82°C)

### Packaging

100' length, coiled, polywrapped

### Branding (Spiral)

Example: Continental ContiTech Harvest® 150 psi WP; FDA/USDA

### Couplings

Contact fitting manufacturer for proper fitting recommendation and coupling procedure.

### Order Codes

549-627

### Harvest®

SAP #	ID	Nom. OD		Max. WP		Bend Radius		Vacuum HG		Weight		
		in.	mm	in.	mm	in.	mm	in.	mm	lb./ft.	kg/m	
20019927	2	50.8	2.73	69.3	150	1.03	5	127	29	737	1.57	2.34
20019928	3	76.2	3.74	95.0	150	1.03	7	178	29	737	2.32	3.45
20019929	4	101.6	4.78	121.4	150	1.03	10	254	29	737	3.44	5.12
20019930	5	127.0	5.91	150.1	150	1.03	15	381	29	737	4.76	7.08

For Continental ContiTech food hose compliance information, see Appendix C.

**Air & Multipurpose**  
General Purpose  
Heavy Duty  
Push-on

Chemical Transfer

Cleaning Equipment

**Food**  
Transfer  
Washdown

Marine

**Material Handling**  
Abrasives  
Bulk Transfer  
Cement & Concrete

Mining

**Petroleum**  
Aircraft Fueling  
Dispensing  
Dock  
Transfer

Spray

Steam

Vacuum

LPG Delivery

**Water**  
Discharge  
Suction & Discharge  
Washdown

Welding

Coupling Systems

Equipment

Appendix

# Nutriflo® Suction and Discharge Hose



## Product Specifications

### Application

For handling almost every type of dry bulk food material or liquid in gravity flow and vacuum service. Nutriflo® conforms to USDA Meat and Poultry, 3-A Sanitary, and FDA Standards, and is used for the transmission of raw and pasteurized milk and other high water content dairy items.

### Construction Tube

Clear Pliovic® (FDA, 3-A, USDA compliant), NSF-61

### Cover

Clear Pliovic®

### Reinforcement

White or Clear high-density Pliovic® helix

### Temperature Range

-15°F to 158°F (-26°C to 70°C)

### Packaging

100' length, coiled, polywrapped

### Branding

Not branded

### Couplings

Contact fitting manufacturer for proper fitting recommendation and coupling procedure.

### Order Codes

586-416 (white)

586-421 (clear)

## Nutriflo® Suction and Discharge

SAP #	ID		Nom. OD		Max. WP		Bend Radius		Vacuum HG		Weight		
	White	Clear	in.	mm	in.	mm	psi	MPa	in.	mm	in.	mm	lb./ft.
20013266	20328013	3/4	19.1	0.99	25.2	120	0.83	3	83	29	737	0.18	0.27
20013269	20013329	1	25.4	1.24	31.5	106	0.73	5	114	29	737	0.26	0.39
20013274	20013330	1¼	31.8	1.55	39.4	99	0.68	5	127	29	737	0.36	0.54
20013279	20013331	1½	38.1	1.78	45.2	89	0.61	6	152	29	737	0.43	0.64
20013283	20013332	2	50.8	2.37	60.2	79	0.54	8	203	29	737	0.67	1.00
20013287	20013333	2½	63.5	2.89	73.4	65	0.45	10	254	29	737	0.89	1.32
20013290	20013334	3	76.2	3.48	88.4	65	0.45	12	305	29	737	1.15	1.71
20013293	20013335	4	101.6	4.50	114.3	55	0.38	16	406	29	737	1.65	2.46
20013297	20013337	6	152.4	6.63	168.4	47	0.32	36	914	29	737	3.39	5.04

For Continental ContiTech food hose compliance information, see Appendix C.

**Air & Multipurpose**

- General Purpose
- Heavy Duty
- Push-on

Chemical Transfer

Cleaning Equipment

**Food**

- Transfer
- Washdown

Marine

**Material Handling**

- Abrasives
- Bulk Transfer
- Cement & Concrete

Mining

**Petroleum**

- Aircraft Fueling
- Dispensing
- Dock Transfer

Spray

Steam

Vacuum

LPG Delivery

**Water**

- Discharge
- Suction & Discharge
- Washdown

Welding

Coupling Systems

Equipment

Appendix

# Nutriflex™ Suction and Discharge Hose



## Product Specifications

### Application

Nutriflex™ S&D hose is capable of handling almost every type of dry bulk food material or liquid in gravity flow and vacuum service. Nutriflex™ conforms to USDA Meat and Poultry, 3-A Sanitary, and FDA Standards, and is used for transmission of raw and pasteurized milk and other high water content dairy items.

### Construction Tube

Clear Pliovic® (FDA, 3-A, USDA compliant), NSF-61

### Cover

Clear Pliovic® (corrugated construction)

### Reinforcement

Clear high-density rigid Pliovic® helix

### Temperature Range

-15°F to 158°F (-26°C to 70°C)

### Packaging

100' length, coiled, polywrapped

### Branding

Not branded

### Couplings

Contact fitting manufacturer for proper fitting recommendation and coupling procedure.

### Order Codes

586-417 (white)

586-422 (clear)

## Nutriflex™ Suction and Discharge

SAP #		ID		Nom. OD		Max. WP		Bend Radius		Vacuum HG		Weight	
White	Clear	in.	mm	in.	mm	psi	MPa	in.	mm	in.	mm	lb./ft.	kg/m
20013300	20013338	1	25.4	1.29	32.8	60	0.41	2	38	29	737	0.22	0.33
20013303	20013339	1¼	31.8	1.56	39.6	50	0.34	3	64	29	737	0.28	0.42
20013306	20013340	1½	38.1	1.88	47.8	50	0.34	4	81	29	737	0.31	0.46
20013309	20013341	2	50.8	2.43	61.7	40	0.28	4	81	29	737	0.51	0.76
20013311	20013342	2½	63.5	3.00	76.2	35	0.24	5	114	29	737	0.82	1.22
20013313	20013343	3	76.2	3.58	90.9	35	0.24	7	165	29	737	1.05	1.56
20013315	20013344	4	101.6	4.71	119.6	35	0.24	10	264	29	737	1.67	2.49
20118679	20013345	6	152.4	6.72	170.7	25	0.17	30	747	29	737	2.27	3.38

For Continental ContiTech food hose compliance information, see Appendix C.

Air & Multipurpose  
General Purpose  
Heavy Duty  
Push-on

Chemical Transfer

Cleaning Equipment

**Food**  
Transfer  
Washdown

Marine

**Material Handling**  
Abrasives  
Bulk Transfer  
Cement & Concrete

Mining

**Petroleum**  
Aircraft Fueling  
Dispensing  
Dock  
Transfer

Spray

Steam

Vacuum

LPG Delivery

**Water**  
Discharge  
Suction & Discharge  
Washdown

Welding

Coupling Systems

Equipment

Appendix

# Nutriflex™ Static Wire



## Product Specifications

### Application

For handling almost every type of dry bulk food material or liquid in gravity flow and vacuum service. Nutriflex™ Static Wire conforms to USDA Meat and Poultry, 3-A Sanitary, and FDA Standards, and is recommended for transmission of powder pellets or granular materials.

### Temperature Range

-15°F to 158°F (-26°C to 70°C)

### Packaging

100' length, coiled, polywrapped

### Branding

Not branded

### Couplings

Contact fitting manufacturer for proper fitting recommendation and coupling procedure.

### Order Codes

586-472

### Construction Tube

Clear Pliovic® (FDA, 3-A, USDA compliant), NSF-61

### Cover

Clear Pliovic® (corrugated construction) static wire placed between the tube and cover

### Reinforcement

Clear, high-density Pliovic® helix

## Nutriflex™ Static Wire

SAP #	ID		Nom. OD		Max. WP		Bend Radius		Vacuum HG		Weight	
	Clear	in.	mm	in.	mm	psi	MPa	in.	mm	in.	mm	lb./ft.
20050287	1/4	31.8	1.56	39.6	50	0.34	3	64	29	737	0.29	0.43
20013602	1/2	38.1	1.84	46.8	50	0.34	4	81	29	737	0.36	0.54
20119161	3/4	44.5	2.09	53.1	45	0.31	4	81	29	737	0.40	0.60
20013603	2	50.8	2.43	61.7	40	0.28	4	89	29	737	0.52	0.77
20013604	2 1/2	63.5	3.00	76.2	35	0.24	5	114	29	737	0.80	1.19
20013605	3	76.2	3.58	90.9	35	0.24	7	165	29	737	1.09	1.62
20013606	4	101.6	4.65	118.1	35	0.24	11	264	29	737	1.51	2.25
20013607	5	127.0	5.75	146.1	35	0.24	22	559	29	737	2.15	3.20
20013608	6	152.4	6.87	174.5	25	0.17	30	747	28	711	2.98	4.43

For Continental ContiTech food hose compliance information, see Appendix C.

Air & Multipurpose  
General Purpose  
Heavy Duty  
Push-on

Chemical Transfer

Cleaning Equipment

**Food**  
Transfer  
Washdown

Marine

**Material Handling**  
Abrasives  
Bulk Transfer  
Cement & Concrete

Mining

**Petroleum**  
Aircraft Fueling  
Dispensing  
Dock  
Transfer

Spray

Steam

Vacuum

LPG Delivery

**Water**  
Discharge  
Suction & Discharge  
Washdown

Welding

Coupling Systems

Equipment

Appendix



# Plicord® Blue Flour



## Product Specifications

### Application

Tank truck or in-plant service hose is for discharge transfer of abrasive materials and dry foods such as flour, cake mixes, etc.

### Construction Tube

3/16" gauge white Pureten™ tube (FDA compliant)

### Cover

Blue SBR rubber (wrapped impression)

### Reinforcement

Spiral-plied synthetic fabric with 2 antistatic wires

### Temperature Range

-40°F to 180°F (-40°C to 82°C)

### Packaging

100' length, coiled, polywrapped

### Branding (Spiral)

Example: Continental ContiTech Plicord® Blue Flour Discharge FDA 150 psi

### Couplings

Contact fitting manufacturer for proper fitting recommendation and coupling procedure.

### Order Codes

549-503

## Plicord® Blue Flour

SAP #	ID		Nom. OD		Max. WP		Weight	
	in.	mm	in.	mm	psi	MPa	lb./ft.	kg/m
20019792	2	50.8	2.68	68.1	150	1.03	1.39	2.07
20019794	3	76.2	3.69	93.7	150	1.03	2.02	3.01
20019795	4	101.6	4.71	119.6	150	1.03	2.63	3.91
20019796	5	127.0	5.72	145.3	150	1.03	3.27	4.87

For Continental ContiTech food hose compliance information, see Appendix C.

**Air & Multipurpose**  
General Purpose  
Heavy Duty  
Push-on

Chemical Transfer

Cleaning Equipment

**Food**  
Transfer  
Washdown

Marine

**Material Handling**  
Abrasives  
Bulk Transfer  
Cement & Concrete

Mining

**Petroleum**  
Aircraft Fueling  
Dispensing  
Dock  
Transfer

Spray

Steam

Vacuum

LPG Delivery

**Water**  
Discharge  
Suction & Discharge  
Washdown

Welding

Coupling Systems

Equipment

Appendix

# Plicord® Brewline



**Air & Multipurpose**  
 General Purpose  
 Heavy Duty  
 Push-on

Chemical Transfer

Cleaning Equipment

**Food**  
 Transfer  
 Washdown

Marine

**Material Handling**  
 Abrasives  
 Bulk Transfer  
 Cement & Concrete

Mining

**Petroleum**  
 Aircraft Fueling  
 Dispensing  
 Dock  
 Transfer

Spray

Steam

Vacuum

LPG Delivery

**Water**  
 Discharge  
 Suction & Discharge  
 Washdown

Welding

Coupling Systems

Equipment

Appendix

## Product Specifications

### Application

A quality discharge hose designed specifically for the highly demanding service of transferring non-oily liquid products in wineries and breweries.

### Construction Tube

White chlorobutyl rubber (FDA/USDA compliant and conforms to 3-A Sanitary Standard 18-03)

### Cover

Red EPDM with a white spiral stripe (wrapped impression)

### Reinforcement

Spiral-plyed synthetic fabric, 4 plies to 1½" ID; 6 plies over 1½" ID

### Temperature Range

-40°F to 220°F (-40°C to 104°C)

### Packaging

100' length, coiled, polywrapped

### Branding

Example: Continental ContiTech Plicord® Brewline® hose 250 psi; FDA, 3-A and USDA

### Couplings

Contact fitting manufacturer for proper fitting recommendation and coupling procedure.

### Order Codes

549-885

## Plicord® Brewline

SAP #	ID		Nom. OD		Max. WP		Weight	
	in.	mm	in.	mm	psi	MPa	lb./ft.	kg/m
20020324	3/4	19.1	1.34	34.0	250	1.72	0.54	0.80
20020327	1	25.4	1.69	42.9	250	1.72	0.81	1.21
20032192	1¼	31.8	2.00	50.8	250	1.72	1.05	1.56
20020335	1½	38.1	2.23	56.6	250	1.72	1.19	1.77
20020341	2	50.8	2.88	73.2	250	1.72	1.86	2.77
20020345	2½	63.5	3.51	89.2	250	1.72	2.66	3.96
20020348	3	76.2	4.09	103.9	250	1.72	3.57	5.31
20020352	4	101.6	5.31	134.9	250	1.72	5.43	8.08

For Continental ContiTech food hose compliance information, see Appendix C.

# Plicord® ExtremeFlex™ Food Grade



## Product Specifications

### Application

A high-tech, flexible corrugated hose with pretzel-like agility and proven performance. Best of all, it is available at a non-corrugated price, making it a great value. With ExtremeFlex™, there's even more to appreciate:

- ▶ **Flexible Handling:** Easier to move in and out of tight spaces and around sharp corners.
- ▶ **Lightweight:** Easier to lift and carry, so there are fewer workplace injuries.
- ▶ **Lower Force to Bend:** Easier to connect and disconnect, keeping productivity high.

### Construction Tube

White Chemivic™ synthetic rubber (FDA/USDA compliant and conforms to 3-A Sanitary Standard 18-03)

### Cover

White or gray Chemivic™ corrugated synthetic rubber (wrapped impression)

### Reinforcement

Spiral-plied synthetic fabric with galvanized wire helix

### Temperature Range

-25°F to 212°F (-32°C to 100°C)

### Packaging

Coiled and polywrapped

### Branding (Spiral)

Continental ContiTech Plicord® ExtremeFlex™ Food Grade 150 psi WP

### Couplings

Contact fitting manufacturer for proper fitting recommendations and coupling procedure

### Non-Stock/Sizes

400' minimum order

### Order Codes

- 549-462 (white)
- 549-164 (gray)

## Plicord® ExtremeFlex™ Food Grade

SAP #		ID		Nom. OD		Max. WP		Bend Radius		Vacuum HG		Weight	
White	Gray	in.	mm	in.	mm	psi	MPa	in.	mm	in.	mm	lb./ft.	kg/m
20478040	20483718	2	51.2	2.4	62.0	150	1.03	2	51	29	737	1.00	1.48
20478043	20483781	3	76.1	3.5	89.9	150	1.03	3	76	29	737	1.89	2.79
20478044	20483782	4	102.1	4.6	116.6	150	1.03	4	102	29	737	2.69	3.98

For Continental ContiTech food hose compliance information, see Appendix C.



**Air & Multipurpose**  
General Purpose  
Heavy Duty  
Push-on

Chemical Transfer

Cleaning Equipment

**Food**  
Transfer  
Washdown

Marine

**Material Handling**  
Abrasives  
Bulk Transfer  
Cement & Concrete

Mining

**Petroleum**  
Aircraft Fueling  
Dispensing  
Dock  
Transfer

Spray

Steam

Vacuum

LPG Delivery

**Water**  
Discharge  
Suction & Discharge  
Washdown

Welding

Coupling Systems

Equipment

Appendix

# Plicord® Winline®



## Product Specifications

### Application

A quality, non-toxic hose for handling wine, potable water, and other non-oily liquid food products where the hose must meet FDA requirements. For discharge service and suction service up to 20" hg vacuum at ambient temperature.

### Construction Tube

White chlorobutyl rubber (FDA/USDA compliant and conforms to 3-A Sanitary Standard 18-03)

### Cover

White EPDM rubber with a purple spiral stripe (wrapped impression)

### Reinforcement

Spiral-plied synthetic fabric, 4 plies to 1½" ID; 6 plies over 1½" ID

### Temperature Range

-40°F to 220°F (-40°C to 104°C)

### Packaging

100' length, coiled, polywrapped

### Branding (Spiral)

Example: Continental ContiTech Plicord® Winline® hose 250 psi; FDA, 3-A, and USDA

### Couplings

Contact fitting manufacturer for proper fitting recommendation and coupling procedure.

### Order Codes

549-887

## Plicord® Winline®

SAP #	ID		Nom. OD		Max. WP		Weight	
	in.	mm	in.	mm	psi	MPa	lb./ft.	kg/m
20020367	3/4	19.1	1.39	35.3	250	1.72	0.60	0.89
20020371	1	25.4	1.69	42.9	250	1.72	0.80	1.19
20099578	1¼	31.8	2.00	50.8	250	1.72	1.04	1.55
20020376	1½	38.1	2.23	56.6	250	1.72	1.20	1.79
20020379	2	50.8	2.92	74.2	250	1.72	1.98	2.95
20020380	2½	63.5	3.50	88.9	250	1.72	2.65	3.94
20020382	3	76.2	4.09	103.9	250	1.72	3.55	5.28
20031599	4	101.6	5.30	134.6	250	1.72	5.40	8.04

For Continental ContiTech food hose compliance information, see Appendix C.

Air & Multipurpose  
General Purpose  
Heavy Duty  
Push-on

Chemical Transfer

Cleaning Equipment

**Food**  
Transfer  
Washdown

Marine

**Material Handling**  
Abrasives  
Bulk Transfer  
Cement & Concrete

Mining

**Petroleum**  
Aircraft Fueling  
Dispensing  
Dock  
Transfer

Spray

Steam

Vacuum

LPG Delivery

**Water**  
Discharge  
Suction & Discharge  
Washdown

Welding

Coupling Systems

Equipment

Appendix

# Pliovic® FG (FDA-3A)



## Product Specifications

### Application

A versatile, lightweight, reinforced tubing for the food and beverage, general air, multipurpose, pharmaceutical and cosmetics industries; computer component manufacturers; textile mills; and air-actuated equipment.

### Construction Tube

Clear Pliovic® compound, conforms to FDA, USDA, NSF-61 and 3-A standards

### Cover

Clear Pliovic® compound, conforms to FDA, USDA, NSF-61 and 3-A standards

### Reinforcement

Spiral synthetic yarn

### Temperature Range

-10°F to 158°F (-23°C to 70°C)

### Packaging

1/4"-5/8" - 300' Bagel Pack, one piece  
3/4" and 1" - 200' Bagel Pack, one piece

### Branding

Example: Continental ContiTech Pliovic® FG FDA & 3-A Compliant 3/8" ID (9.5mm) 250 psi WP (1.7 MPa). Made in U.S.A.

### Couplings

Contact fitting manufacturer for proper fitting recommendations and coupling procedure

### Non-Stock/Sizes

Contact customer service for availability on cut, coiled and tied hose lengths.

### Order Codes

540-337

## Pliovic® FG (FDA-3A)

SAP #	ID		Nom. OD		Max. WP		Weight	
	in.	mm	in.	mm	psi	MPa	lb./ft.	kg/m
20129509	1/4	6.4	0.44	11.2	250	1.72	0.05	0.07
20129600	5/16	7.9	0.50	12.7	250	1.72	0.07	0.10
20129601	3/8	9.5	0.59	15.0	250	1.72	0.08	0.12
20129602	1/2	12.7	0.75	19.1	200	1.38	0.12	0.18
20129603	5/8	15.9	0.87	22.1	200	1.38	0.15	0.22
20337878	3/4	19.1	1.02	25.9	150	1.03	0.19	0.28
20316305	1	25.4	1.34	34.0	125	0.86	0.31	0.46
20463346	1¼	31.75	1.72	43.6	125	0.86	0.60	0.89
20463340	1½	38.1	1.98	50.2	125	0.86	0.72	1.07
20462279	2	50.8	2.51	63.8	100	0.69	1.00	1.48

For Continental ContiTech food hose compliance information, see Appendix C.

**Air & Multipurpose**  
General Purpose  
Heavy Duty  
Push-on

Chemical Transfer

Cleaning Equipment

**Food**  
Transfer  
Washdown

Marine

**Material Handling**  
Abrasives  
Bulk Transfer  
Cement & Concrete

Mining

**Petroleum**  
Aircraft Fueling  
Dispensing  
Dock  
Transfer

Spray

Steam

Vacuum

LPG Delivery

**Water**  
Discharge  
Suction & Discharge  
Washdown

Welding

Coupling Systems

Equipment

Appendix

# Potable Water



## Product Specifications

### Application

Designed to handle water suitable for drinking. Used in oilfield or industrial applications. Used in discharge service only. This hose is not NSF approved.

### Construction Tube

White natural rubber (complies with FDA requirements)

### Cover

Blue SBR (smooth, wrapped impression)

### Reinforcement

Synthetic textile fabric plies

### Temperature Range

-40°F to 180°F (-40°C to 82°C)

### Packaging

Coiled-polyethylene wrapped/bagel pack

### Branding (Spiral)

Example: Continental ContiTech Potable Water Hose

### Couplings

Contact fitting manufacturer for proper fitting recommendation and coupling procedure.

### Order Codes

542-445

## Potable Water

SAP #	ID	Nom. OD		Max. WP		Weight		
		in.	mm	psi	MPa	lb./ft.	kg/m	
20016702	1	25.4	1.49	37.9	250	1.72	0.55	0.82
20016704	1½	38.1	1.98	50.3	250	1.38	0.77	1.15
20016706	2	50.8	2.50	63.5	150	1.03	0.96	1.43
20344236	3	76.2	3.58	91.0	150	1.03	1.72	2.56
20016709	4	101.6	4.56	115.8	150	1.03	1.99	2.96

For Continental ContiTech food hose compliance information, see Appendix C.

Air & Multipurpose  
General Purpose  
Heavy Duty  
Push-on

Chemical Transfer

Cleaning Equipment

**Food**  
Transfer  
Washdown

Marine

**Material Handling**  
Abrasives  
Bulk Transfer  
Cement & Concrete

Mining

**Petroleum**  
Aircraft Fueling  
Dispensing  
Dock  
Transfer

Spray

Steam

Vacuum

LPG Delivery

**Water**  
Discharge  
Suction & Discharge  
Washdown

Welding

Coupling Systems

Equipment

Appendix

# Vintner™



## Product Specifications

### Application

For handling in-plant and/or tank truck transfer of wine, beer, potable water and other non-oily, liquid foodstuffs.

### Construction Tube

White chlorobutyl (FDA/USDA compliant and conforms to 3-A Sanitary Standard 18-03)

### Cover

Gray EPDM synthetic rubber (wrapped) / purple branding tape

### Reinforcement

Spiral-plied synthetic fabric with Monofilament Helix

### Temperature Range

-30°F to 220°F (- 34°C to 104°C)

### Packaging

100' length, coiled, polywrapped

### Branding (Spiral)

Example: Continental ContiTech Plicord® Vintner™ 250 psi; FDA, 3-A, and USDA

### Couplings

Contact fitting manufacturer for proper fitting recommendations and coupling procedure

### Non-Stock/Sizes

Contact customer service for availability on cut, coiled and tied hose lengths.

### Order Codes

549-886

## Vintner™

SAP #	ID	Nom. OD		Max. WP		Bend Radius		Vacuum HG		Weight		
		in.	mm	psi	MPa	in.	mm	in.	mm	lb./ft.	kg/m	
20020354	1	25.4	1.62	41.1	250	1.72	3	76	27	686	0.71	1.06
20020356	1½	38.1	2.11	53.6	250	1.72	4	102	27	686	0.98	1.46
20020361	2	50.8	2.68	68.1	250	1.72	7	178	27	686	1.38	2.05
20020362	2½	63.5	3.21	81.5	250	1.72	10	254	27	686	1.78	2.65
20020365	3	76.2	3.85	97.8	250	1.72	12	305	27	686	2.59	3.86

For Continental ContiTech food hose compliance information, see Appendix C.

**Air & Multipurpose**  
General Purpose  
Heavy Duty  
Push-on

Chemical Transfer

Cleaning Equipment

**Food**  
Transfer  
Washdown

Marine

**Material Handling**  
Abrasives  
Bulk Transfer  
Cement & Concrete

Mining

**Petroleum**  
Aircraft Fueling  
Dispensing  
Dock  
Transfer

Spray

Steam

Vacuum

LPG Delivery

**Water**  
Discharge  
Suction & Discharge  
Washdown

Welding

Coupling Systems

Equipment

Appendix

# Plicord® ExtremeFlex™ Beverage Gray



## Product Specifications

### Application

For beer, wine, distillery and beverage (edible liquid) transfer processing facilities. Ideal for applications requiring flexible and/or tight bend connections.

### Construction Tube

White Chlorobutyl (FDA/USDA compliant & conforms to a 3-A Sanitary Standard 18-03)

### Cover

Corrugated grey chemical (wrapped impression), New corrugated red EZ Clean UHMWPE cover (semi-smooth finish)

### Reinforcement

Spiral-plyed fabrics with double galvanized helix wire

### Temperature Range

-30°F to 220°F (-34°C to 104°C)

### Couplings

Tri-Clamp or Sanitary ends are typically used with this hose

### Order Codes

549-603 Gray Cover

## Plicord® ExtremeFlex™ Beverage Gray

Part #	ID		Nom. OD		Max. WP		Bend Radius		Vacuum HG @ 72°F		Weight	
	in.	mm	in.	mm	psi	MPa	in.	mm	in.	mm	lb./ft.	kg/m
20762678	1	25.4	1.56	39.7	250	1.72	1.5	38	29	737	0.73	1.09
20762679	1½	38.1	2.02	51.3	250	1.72	2.3	57	29	737	0.92	1.38
20762751	2	50.8	2.53	64.2	250	1.72	3.0	76	29	737	1.20	1.79
20762752	3	76.2	3.59	91.2	200	1.38	4.5	114	29	737	2.02	3.01
20762753	4	101.6	4.60	116.8	150	1.03	6.0	152	29	737	2.76	4.11

**Air & Multipurpose**  
General Purpose  
Heavy Duty  
Push-on

Chemical Transfer

Cleaning Equipment

**Food**  
Transfer  
Washdown

Marine

**Material Handling**  
Abrasives  
Bulk Transfer  
Cement & Concrete

Mining

**Petroleum**  
Aircraft Fueling  
Dispensing  
Dock  
Transfer

Spray

Steam

Vacuum

LPG Delivery

**Water**  
Discharge  
Suction & Discharge  
Washdown

Welding

Coupling Systems

Equipment

Appendix



# Plicord® ExtremeFlex™ Beverage Red with EZ Clean Cover



## Product Specifications

### Application

For beer, wine, distillery and beverage (edible liquid) transfer processing facilities. Ideal for applications requiring flexible and/or tight bend connections.

### Construction Tube

White Chlorobutyl (FDA/USDA compliant & conforms to a 3-A Sanitary Standard 18-03)

### Cover

Corrugated grey chemical (wrapped impression), New corrugated red EZ Clean UHMWPE cover (semi-smooth finish)

### Reinforcement

Spiral-plied fabrics with double galvanized helix wire

### Temperature Range

-30°F to 220°F (-34°C to 104°C)

### Couplings

Tri-Clamp or Sanitary ends are typically used with this hose

### Order Codes

549-605 EZ Clean Red Cover

## Plicord® ExtremeFlex™ Beverage Red

Part #	ID		Nom. OD		Max. WP		Bend Radius		Vacuum HG @ 72°F		Weight	
	in.	mm	in.	mm	psi	MPa	in.	mm	in.	mm	lb./ft.	kg/m
20776605	1	25.4	1.52	38.7	250	1.72	2	51	29	737	0.65	0.96
20762754	1½	38.1	2.03	51.6	250	1.72	3	76	29	737	0.93	1.38
20752524	2	50.8	2.537	64.5	250	1.72	4	102	29	737	1.21	1.80
20762758	3	76.2	3.601	91.5	200	1.38	6	152	29	737	2.03	3.02
20762760	4	101.6	4.607	117	150	1.03	8	203	29	737	2.77	4.12

Air & Multipurpose  
General Purpose  
Heavy Duty  
Push-on

Chemical Transfer

Cleaning Equipment

**Food**  
Transfer  
Washdown

Marine

**Material Handling**  
Abrasives  
Bulk Transfer  
Cement & Concrete

Mining

**Petroleum**  
Aircraft Fueling  
Dispensing  
Dock  
Transfer

Spray

Steam

Vacuum

LPG Delivery

**Water**  
Discharge  
Suction & Discharge  
Washdown

Welding

Coupling Systems

Equipment

Appendix

# Tan Flexwing®



**Air & Multipurpose**

- General Purpose
- Heavy Duty
- Push-on

Chemical Transfer

Cleaning Equipment

**Food**

- Transfer
- Washdown

Marine

**Material Handling**

- Abrasives
- Bulk Transfer
- Cement & Concrete

Mining

**Petroleum**

- Aircraft Fueling
- Dispensing
- Dock Transfer

Spray

Steam

Vacuum

LPG Delivery

**Water**

- Discharge
- Suction & Discharge
- Washdown

Welding

Coupling Systems

Equipment

Appendix

## Product Specifications

**Application**

Tan Flexwing® is for acids, alcohol bases and salt solutions.

**Construction Tube**

Tan Pureten™ gum rubber (non oil-resistant) (FDA/USDA compliant)

**Cover**

Tan SBR synthetic rubber (non oil-resistant) with blue spiral stripe (wrapped impression)

**Reinforcement**

Spiral-plied synthetic fabric with wire helix

**Temperature Range**

-40°F to 180°F (-40°C to 82°C)

**Packaging**

100' lengths, coiled and polywrapped

**Branding (Spiral)**

Example: Continental ContiTech Tan Flexwing® with Pureten™ 150 psi WP

**Couplings**

Contact fitting manufacturer for proper fitting recommendation and coupling procedure.

**Order Codes**

549-986

### Tan Flexwing®

Material	ID		Nom. OD		Max. WP		Bend Radius		Vacuum HG		Weight	
	in.	mm	in.	mm	psi	MPa	in.	mm	in.	mm	lb./ft.	kg/m
20790764	2	50.8	2.68	68.1	150	1.03	5.0	127	29	737	1.44	2.14
20790765	3	76.2	3.75	95.3	150	1.03	7.0	178	29	737	2.32	3.45
20790766	4	101.6	4.83	122.7	150	1.03	10.0	254	29	737	3.39	5.04

# Tan Flextra®



## Product Specifications

### Application

For tank truck and in-plant service. Used to convey non-oily abrasive materials such as sand, limestone, plastic pellets and dry abrasive food products

### Construction Tube

Pureten™ gum rubber (non oil-resistant) (FDA/USDA compliant)

### Cover

Tan SBR gum rubber (corrugated) with yellow spiral stripe (wrapped impression)

### Reinforcement

Spiral-plied synthetic fabric with wire helix

### Temperature Range

-40°F to 180°F (-40°C to 82°C)

### Packaging

100' length, coiled, polywrapped

### Branding (Spiral)

Example: Continental ContiTech Tan Flextra® with Pureten™ 75 psi WP

### Couplings

Contact fitting manufacturer for proper fitting recommendations and coupling procedure

### Non-Stock/Sizes

Contact customer service for availability on cut, coiled and tied hose lengths.

### Order Codes

549-987

### Tan Flextra®

Material	ID		Nom. OD		Max. WP		Bend Radius		Vacuum HG		Weight	
	in.	mm	in.	mm	psi	MPa	in.	mm	in.	mm	lb./ft.	kg/m
20790761	2	50.8	2.60	66.0	75	0.52	4	102	29	737	1.21	1.80
20790762	3	76.2	3.63	92.2	75	0.52	6	152	29	737	1.94	2.89
20790763	4	101.6	4.69	119.1	75	0.52	9	229	29	737	2.74	4.08

**Air & Multipurpose**  
General Purpose  
Heavy Duty  
Push-on

Chemical Transfer

Cleaning Equipment

**Food**  
Transfer  
Washdown

Marine

**Material Handling**  
Abrasives  
Bulk Transfer  
Cement & Concrete

Mining

**Petroleum**  
Aircraft Fueling  
Dispensing  
Dock  
Transfer

Spray

Steam

Vacuum

LPG Delivery

**Water**  
Discharge  
Suction & Discharge  
Washdown

Welding

Coupling Systems

Equipment

Appendix

# Tan Softwall



## Product Specifications

### Application

A fabric-reinforced hose for the discharge of non-oily abrasive materials such as sand, limestone, gravel, plastic pellets and dry food products. For use where static electrical buildup is not a problem.

### Construction Tube

Tan Pureten™ gum rubber (FDA/USDA compliant)

### Cover

Tan SBR synthetic rubber (wrapped impression)

### Reinforcement

Spiral-plied synthetic fabric with static wire

### Temperature Range

-40°F to 180°F (-40°C to 82°C)

### Packaging

100' lengths, coiled and polywrapped

### Branding (Spiral)

Example: Continental ContiTech Tan Softwall with Pureten™ 75 psi WP

### Couplings

Contact fitting manufacturer for proper fitting recommendation and coupling procedure.

### Order Codes

549-988

## Tan Softwall

Material	ID		Nom. OD		Max. WP		Weight	
	in.	mm	in.	mm	psi	MPa	lb./ft.	kg/m
20790767	3	76.2	3.69	93.7	75	0.52	1.80	2.68
20790768	4	101.6	4.78	121.4	75	0.52	2.61	3.88

Air & Multipurpose

General Purpose

Heavy Duty

Push-on

Chemical Transfer

Cleaning Equipment

**Food**

Transfer

Washdown

Marine

**Material Handling**

Abrasives

Bulk Transfer

Cement & Concrete

Mining

**Petroleum**

Aircraft Fueling

Dispensing

Dock

Transfer

Spray

Steam

Vacuum

LPG Delivery

**Water**

Discharge

Suction & Discharge

Washdown

Welding

Coupling Systems

Equipment

Appendix

# Food Transfer

## Food Hose Recommendation Guide - Specific Hose Application Capabilities

Tube: Compound	Chemivic	Pureten	Pureten	Chlorobutyl	Pliovic
Tube: Color	White	Tan	White	White	Clear
Hose Name	White Flexwing, White Flextra, Gray Flextra LT, Gray Food White Softwall	Flexwing, Tan Flextra, Tan Softwall	Blue Flour Discharge, Harvest	Winline, Brewline, Vintner	Pliovic FG, Nutriflo, Nutriflex, Nutriflex SW
<b>Food</b>					
<b>(B)</b>					
Beet Sugar, Granular	I	A	A	X	B
Buttermilk, Dried	X	A	A	X	B
<b>(C)</b>					
Cane Sugar, Granular	I	A	A	X	B
Cashew Nut Oil	A	X	X	X	X
Castor Oil	A	X	X	X	X
Citric Acid	A	A	A	A	B
Cocoa Butter	A	X	X	X	I
Coconut Oil	A	X	X	X	X
Corn Oil	A	X	X	X	X
Cottonseed Oil	A	X	X	X	X
<b>(F)</b>					
Fish Meal	A	X	X	X	B
Flour	I	A	A	X	
<b>(G)</b>					
Grape Juice	A	X	X	A	B
<b>(L)</b>					
Lactic Acid	A	B	B	B	X
Lard Oil	A	X	X	X	X
Linseed Oil	A	X	X	X	X
Liquor (Spirits)	B	X	X	X	B
<b>(M)</b>					
Milk	A	X	X	A	B
Mineral Oil	A	X	X	X	B
Molasses	A	A	A	A	A
<b>(O)</b>					
Olive Oil	A	X	X	X	X
Orange Juice	A	X	X	A	A
<b>(P)</b>					
Palm Oil	A	X	X	X	X
Paraffin	A	X	X	X	B
Peanut Oil	A	X	X	X	X
Potato Flour	I	A	A	A	A
<b>(S)</b>					
Salt, Granular, Table Grade	I	A	A	X	A
Shortening	A	X	X	X	I
Soybean Oil	A	X	X	X	X
Sucrose	A	A	A	X	A
Sugar, Granulated	I	A	A	X	A
Sugar, Syrup	A	A	A	A	A
<b>(T)</b>					
Tallow	A	X	X	X	X
Tomato Juice, Paste & Puree Sauce	A	X	X	I	B
<b>(V)</b>					
Vegetable Oil	A	X	X	X	X
Vinegar	A	X	X	A	A
<b>(W)</b>					
Water, Potable	A	X	X	A	A
Whiskey	B	X	X	X	X
Wine	A	X	X	A	I

Key: A - Excellent; B - Good; X - Not recommended; I - Insufficient information.

Note: For temperatures in excess of 150°F (66°C), consult Customer Service.

Air & Multipurpose  
General Purpose  
Heavy Duty  
Push-on

Chemical Transfer

Cleaning Equipment

**Food**  
Transfer  
Washdown

Marine

Material Handling  
Abrasives  
Bulk Transfer  
Cement & Concrete

Mining

Petroleum  
Aircraft Fueling  
Dispensing  
Dock  
Transfer

Spray

Steam

Vacuum

LPG Delivery

Water  
Discharge  
Suction & Discharge  
Washdown

Welding

Coupling Systems

Equipment

Appendix

# Food Washdown



**Air & Multipurpose**  
 General Purpose  
 Heavy Duty  
 Push-on

Chemical Transfer

Cleaning Equipment

**Food  
 Transfer  
 Washdown**

Marine

**Material Handling**  
 Abrasives  
 Bulk Transfer  
 Cement & Concrete

Mining

**Petroleum**  
 Aircraft Fueling  
 Dispensing  
 Dock  
 Transfer

Spray

Steam

Vacuum

LPG Delivery

**Water**  
 Discharge  
 Suction & Discharge  
 Washdown

Welding

Coupling Systems

Equipment

Appendix

	Page	Non-Marking	Superior Oil Resistance Tube and Cover	Superior Abrasion Cover	Anti Microbial Cover	Tapered Nozzle	Wire	Textile
Blue Fortress 300	90	Yes	Yes	Yes	Yes			Yes
Fortress 300	87	Yes	Yes	Yes	Yes			Yes
Fortress 1000	88	Yes	Yes	Yes	Yes			Yes
Fortress 3000	89	Yes	Yes	Yes	Yes		Yes	
Gauntlet 1500	60	Yes*	Yes	Yes				Yes
Plicord Washdown	251					Yes		Yes
Sani-Wash 300	92	Yes						Yes
Sani-Wash Plus 300	91	Yes	Yes					Yes
Super Sani-Wash 300	93	Yes			Yes			Yes

\*Non-black colors.

# Fortress® 300 with Microban® Product Protection



## Product Specifications

### Application

A high-quality construction for hot water up to 200°F (93°C) for cleanup service in food processing plants, dairies, packing houses, bottling plants, breweries, canneries and creameries. Its super abrasion and oil-resistant cover provides maximum protection against the adverse effects of oil and animal fats. The cover of our Fortress® 300 hose incorporates Microban's\*\* antimicrobial built-in product protection.

### Construction Tube

Black Nitrile synthetic rubber

### Cover

Yellow Carbryn™ synthetic rubber, RMA Class A (High Oil Resistance) with Microban® product protection

### Reinforcement

Spiral synthetic yarn

### Temperature Range

-20°F to 200°F (-29°C to 93°C)

### Packaging

1/2"-3/4" - 500' reels, maximum 3 pieces, 50' increments  
1" - 450' reels, maximum 3 pieces, 50' increments

### Branding

Example: Fortress® 300 with Microban® Antimicrobial Product Protection 3/8" 300 psi WP. Made in U.S.A. Continental ContiTech

### Couplings

Use Continental ContiTech pressure washing fittings with this product. See the Coupling Systems information pages at the back of the catalog for available sizes. Refer to the Continental ContiTech Hose Assembly Manual for crimp procedures. Coupled lengths with MxMS fittings and Kink Guards available.

### Non-Stock/Sizes

Contact customer service for availability on cut, coiled and tied hose lengths.

### Order Codes

569-120 (yellow)

## Fortress® 300

SAP #	ID		Nom. OD		Max. WP		Weight		Water Discharge Suction & Discharge Washdown Welding Coupling Systems
	Yellow	in.	mm	in.	mm	psi	MPa	lb./ft.	
20135640	1/2		12.7	0.90	22.8	300	2.07	0.29	0.43
20135644	5/8		15.9	1.06	27.0	300	2.07	0.36	0.54
20135645	3/4		19.1	1.19	30.2	300	2.07	0.41	0.61
20135646	1		25.4	1.50	38.1	300	2.07	0.60	0.89

\*Microban® antimicrobial product protection inhibits the growth of bacteria, mold and fungi that can cause odor, stains or degradation of the hose cover.

Microban® is intended to protect the hose cover only. It is not a substitute for good sanitary practices.

Air & Multipurpose  
General Purpose  
Heavy Duty  
Push-on

Chemical Transfer

Cleaning Equipment

Food  
Transfer  
Washdown

Marine

Material Handling  
Abrasives  
Bulk Transfer  
Cement & Concrete

Mining

Petroleum  
Aircraft Fueling  
Dispensing  
Dock  
Transfer

Spray

Steam

Vacuum

LPG Delivery

Water  
Discharge  
Suction & Discharge  
Washdown

Welding

Coupling Systems

Equipment

Appendix

# Fortress® 1000 with Microban® Product Protection



## Product Specifications

### Application

For use on pressure washer machines with working pressures up to 1000 psi. Applications include washdown service in food processing plants, dairies, packing houses, bottling plants, breweries, canneries and creameries. Its super abrasion and oil-resistant cover provides maximum protection against the adverse effects of oil and animal fats. The cover of our Fortress® Washdown hose incorporates Microban's\*\* antimicrobial built-in product protection.

### Construction Tube

Nitrile synthetic rubber

### Cover

Carbryn™ synthetic rubber, RMA Class A (High Oil Resistance) with Microban® product protection

### Reinforcement

Braided (1) synthetic yarn

### Temperature Range

-20°F to 200°F (-29°C to 93°C)

### Packaging

500' reels, maximum 3 pieces, 50' increments: coupled lengths available

### Branding

Example: Fortress® 1000 with Microban® Antimicrobial Product Protection 3/8" 1000 psi WP. Made in U.S.A. Continental ContiTech

### Couplings

Contact fitting manufacturer for proper fitting recommendation and coupling procedure.

### Order Codes

536-575 (yellow)  
536-583 (red)  
536-481 (blue)

## Fortress® 1000

SAP #	ID		Nom. OD		Max. WP		Weight	
	in.	mm	in.	mm	psi	MPa	lb./ft.	kg/m
20451915	1/4	6.4	0.59	15.0	1000	6.9	0.12	0.18
20139345	3/8	9.5	0.75	19.1	1000	6.9	0.18	0.27
20141359	1/2	12.7	0.86	21.8	1000	6.9	0.20	0.30
20141420	3/4	19.1	1.20	30.5	1000	6.9	0.42	0.62

\*Microban® Antimicrobial Product Protection inhibits the growth of bacteria, mold and fungi that can cause odor, stains or degradation of the hose cover.

Microban® is intended to protect the hose cover only. It is not a substitute for good sanitary practices.

Air & Multipurpose  
General Purpose  
Heavy Duty  
Push-on

Chemical Transfer

Cleaning Equipment

**Food**  
Transfer  
Washdown

Marine

**Material Handling**  
Abrasives  
Bulk Transfer  
Cement & Concrete

Mining

**Petroleum**  
Aircraft Fueling  
Dispensing  
Dock  
Transfer

Spray

Steam

Vacuum

LPG Delivery

**Water**  
Discharge  
Suction & Discharge  
Washdown

Welding

Coupling Systems

Equipment

Appendix



# Fortress® 3000 with Microban® Product Protection



## Product Specifications

### Application

Fortress® 3000 is for use on pressure washer machines with working pressures up to 3000 psi. Applications include washdown service in food processing plants, dairies, packing houses, bottling plants, breweries, canneries and creameries. Its super abrasion and oil-resistant cover provides maximum protection against the adverse effects of oil and animal fats. The cover of Fortress® Washdown hose incorporates Microban's\*\* antimicrobial built-in product protection.

### Construction Tube

Nitrile synthetic rubber

### Cover

Carbryn™ synthetic rubber, RMA Class A (High Oil Resistance) with Microban® built-in product protection

### Reinforcement

Braided (1) steel wire

### Temperature Range

-20°F to 250°F (-29°C to 121°C)

### Packaging

500' reel, maximum 3 pieces, 50' increments: coupled lengths available

### Branding

Example: Fortress® 3000 with Microban® Antimicrobial Product Protection 3/8" 3000 psi WP. Made in U.S.A. Continental ContiTech

### Couplings

Use Continental ContiTech pressure washing fittings with this product. See the Coupling Systems information pages at the back of the catalog for available sizes. Refer to the Continental ContiTech Hose Assembly Manual for crimp procedures. Coupled lengths with MxMS fittings and Kink Guards available.

### Order Codes

539-400 (Yellow)  
539-401 (Blue)

## Fortress® 3000

SAP #	ID		Nom. OD		Max. WP		Weight	
	in.	mm	in.	mm	psi	MPa	lb./ft.	kg/m
20141421	1/4	6.4	0.53	13.5	3000	20.69	0.15	0.22
20139340	3/8	9.5	0.69	17.5	3000	20.69	0.24	0.36
20141423	1/2	12.7	0.82	20.8	3000	20.69	0.32	0.48

\*Microban® antimicrobial product protection inhibits the growth of bacteria, mold and fungi that can cause odor, stains or degradation of the hose cover.

Microban® is intended to protect the hose cover only. It is not a substitute for good sanitary practices.

Air & Multipurpose  
General Purpose  
Heavy Duty  
Push-on

Chemical Transfer

Cleaning Equipment

**Food**  
Transfer  
Washdown

Marine

**Material Handling**  
Abrasives  
Bulk Transfer  
Cement & Concrete

Mining

**Petroleum**  
Aircraft Fueling  
Dispensing  
Dock  
Transfer

Spray

Steam

Vacuum

LPG Delivery

**Water**  
Discharge  
Suction & Discharge  
Washdown

Welding

Coupling Systems

Equipment

Appendix

# Blue Fortress® 300 with Microban® with FDA Compliant White Tube



## Product Specifications

### Application

A high-quality construction for hot water up to 200°F (93°C) cleanup service in food processing plants, dairies, packing houses, bottling plants, breweries, canneries and creameries. Its super abrasion and oil-resistant cover provides maximum protection against the adverse effects of oil and animal fats. The cover of our Blue Fortress® 300 hose incorporates Microban's® antimicrobial built-in product protection. The white tube is comprised of FDA compliant materials.

### Construction Tube

White FDA compliant nitrile synthetic rubber

### Cover

Blue Carbryn™ synthetic rubber, RMA Class A (High Oil Resistance) with Microban® product protection

### Reinforcement

Spiral synthetic yarn

### Temperature Range

-20°F to 200°F (-29°C to 93°C)

### Packaging

Bulk

### Branding

Example: Fortress® 300 with Microban® Antimicrobial Product Protection 3/4" 300 psi WP. Made in U.S.A. Continental ContiTech

### Couplings

Contact fitting manufacturer for proper fitting recommendation and coupling procedure.

### Order Codes

569-121

## Blue Fortress® 300 with FDA Compliant White Tube

SAP #	ID		Nom. OD		Max. WP		Weight	
	in.	mm	in.	mm	psi	MPa	lb./ft.	kg/m
20189064	1/2	12.7	0.90	22.8	300	2.07	0.30	0.45
20630248	5/8	15.8	1.06	26.9	300	2.07	0.37	0.62
20190318	3/4	19.1	1.19	30.2	300	2.07	0.44	0.65
20459020	1	25.4	1.50	38.1	300	2.07	0.57	0.95

\*Microban® antimicrobial product protection inhibits the growth of bacteria, mold and fungi that can cause odor, stains or degradation of the hose cover. Microban® is intended to protect the hose cover only. It is not a substitute for good sanitary practice.

Air & Multipurpose  
General Purpose  
Heavy Duty  
Push-on

Chemical Transfer

Cleaning Equipment

**Food**  
Transfer  
Washdown

Marine

**Material Handling**  
Abrasives  
Bulk Transfer  
Cement & Concrete

Mining

**Petroleum**  
Aircraft Fueling  
Dispensing  
Dock  
Transfer

Spray

Steam

Vacuum

LPG Delivery

**Water**  
Discharge  
Suction & Discharge  
Washdown

Welding

Coupling Systems

Equipment

Appendix

# Sani-Wash™ Plus 300



## Product Specifications

### Application

A high-quality, economical construction for hot water up to 200°F (93°C) cleanup service in food processing plants, dairies, packing houses, bottling plants, breweries, canneries and creameries.

### Construction Tube

Black Nitrile synthetic rubber, RMA Class A (High Oil Resistance), non-FDA

### Cover

White Chemivic™ synthetic rubber, RMA Class A (High Oil Resistance)

### Reinforcement

Spiral synthetic yarn

### Temperature Range

-20°F to 200°F (-29°C to 93°C)

### Packaging

1/2"-3/4" - 500' reels, maximum 3 pieces, 50' increments  
1" - 450' reels, maximum 3 pieces, 50' increments

### Branding

Example: Sani-Wash™ Plus (19.1mm) 300 psi WP. Made in U.S.A. Continental ContiTech

### Couplings

Contact fitting manufacturer for proper fitting recommendation and coupling procedure.

### Order Codes

569-019

## Sani-Wash™ Plus 300

SAP #	ID		Nom. OD		Max. WP		Weight	
	in.	mm	in.	mm	psi	MPa	lb./ft.	kg/m
20026069	1/2	12.7	0.91	23.1	300	2.07	0.27	0.40
20026071	3/4	19.1	1.18	30.0	300	2.07	0.40	0.60
20026078	1	25.4	1.50	38.1	275	1.90	0.60	0.89

**Air & Multipurpose**  
General Purpose  
Heavy Duty  
Push-on

Chemical Transfer

Cleaning Equipment

**Food**  
Transfer  
Washdown

Marine

**Material Handling**  
Abrasives  
Bulk Transfer  
Cement & Concrete

Mining

**Petroleum**  
Aircraft Fueling  
Dispensing  
Dock  
Transfer

Spray

Steam

Vacuum

LPG Delivery

**Water**  
Discharge  
Suction & Discharge  
Washdown

Welding

Coupling Systems

Equipment

Appendix

# Sani-Wash™ 300



**Air & Multipurpose**  
 General Purpose  
 Heavy Duty  
 Push-on

Chemical Transfer

Cleaning Equipment

**Food**  
 Transfer  
 Washdown

Marine

**Material Handling**  
 Abrasives  
 Bulk Transfer  
 Cement & Concrete

Mining

**Petroleum**  
 Aircraft Fueling  
 Dispensing  
 Dock  
 Transfer

Spray

Steam

Vacuum

LPG Delivery

**Water**  
 Discharge  
 Suction & Discharge  
 Washdown

Welding

Coupling Systems

Equipment

Appendix

## Product Specifications

### Application

An economical hose for hot water washdown up to 205°F (96°C) cleanup in food processing plants, dairies, packing houses, bottling plants, breweries, canneries and creameries.

### Construction Tube

EPDM synthetic rubber

### Cover

White EPDM synthetic rubber

### Reinforcement

Textile reinforced

### Temperature Range

-40°F to 205°F (-40°C to 96°C)

### Packaging

1/2"-3/4" - 500' reels, maximum 3 pieces, 50' increments  
 1" - 450' reels, maximum 3 pieces, 50' increments

### Branding

Example: Continental ContiTech Sani-Wash™ 300 psi WP 3/4" (19.1mm). Made in U.S.A.

### Couplings

Contact fitting manufacturer for proper fitting recommendations and coupling procedure

### Order Codes

569-020

## Sani-Wash™ 300

SAP #	ID		Nom. OD		Max. WP		Weight		
	White	in.	mm	in.	mm	psi	MPa	lb./ft.	kg/m
20070992	1/2		12.7	0.84	21.3	300	2.07	0.26	0.39
20136571	5/8		15.9	1.00	25.4	300	2.07	0.31	0.46
20070993	3/4		19.1	1.17	29.7	300	2.07	0.42	0.63
20070994	1		25.4	1.47	37.3	300	2.07	0.62	0.92

# Super Sani-Wash™ 300



## Product Specifications

### Application

An economical hose for hot water washdown up to 200°F (93°C) cleanup in food processing plants, dairies, packing houses, bottling plants, breweries, canneries and creameries. The cover of the Super Sani-Wash™ Washdown hose incorporates Microban's® antimicrobial built-in product protection.

### Construction Tube

EPDM synthetic rubber

### Cover

White EPDM synthetic rubber with Microban® product protection

### Reinforcement

Spiral textile reinforced

### Temperature Range

-40°F to 200°F (- 40°C to 93°C)

### Packaging

Reels

### Branding

Example: Continental ContiTech Super Sani-Wash™ 300 with Microban® antimicrobial product protection 300 psi WP. 3/4" (19.1mm). Made in U.S.A.

### Couplings

Contact fitting manufacturer for proper fitting recommendation and coupling procedure.

### Non-Stock/Sizes

For special production run minimum requirements, see Appendix C.

### Order Codes

569-021

## Super Sani-Wash™ 300

SAP #	ID		Nom. OD		Max. WP		Weight	
	in.	mm	in.	mm	psi	MPa	lb./ft.	kg/m
20449743	1/2	12.7	0.84	21.3	300	2.07	0.26	0.39
20448570	3/4	19.1	1.17	29.7	300	2.07	0.42	0.63
20449746	1	25.4	1.47	37.3	300	2.07	0.62	0.92

\*Microban® antimicrobial product protection inhibits the growth of bacteria, mold and fungi that can cause odor, stains or degradation of the hose cover. Microban® is intended to protect the hose cover only. It is not a substitute for good sanitary practice.

**Air & Multipurpose**  
General Purpose  
Heavy Duty  
Push-on

Chemical Transfer

Cleaning Equipment

**Food**  
Transfer  
Washdown

Marine

**Material Handling**  
Abrasives  
Bulk Transfer  
Cement & Concrete

Mining

**Petroleum**  
Aircraft Fueling  
Dispensing  
Dock  
Transfer

Spray

Steam

Vacuum

LPG Delivery

**Water**  
Discharge  
Suction & Discharge  
Washdown

Welding

Coupling Systems

Equipment

Appendix

# Marine

**Air & Multipurpose**

- General Purpose
- Heavy Duty
- Push-on

Chemical Transfer

Cleaning Equipment

**Food**

- Transfer
- Washdown

**Marine**

**Material Handling**

- Abrasives
- Bulk Transfer
- Cement & Concrete

**Mining**

**Petroleum**

- Aircraft Fueling
- Dispensing
- Dock
- Transfer

Spray

Steam

Vacuum

LPG Delivery

**Water**

- Discharge
- Suction & Discharge
- Washdown

Welding

Coupling Systems

Equipment

Appendix



	Page	SAE	USCG	Hardwall	Softwall
Flexshield™ Marine Barrier Hose USCG/SAE J1527 & ISO 7840 Type A1-15	101	Yes	Yes		
Marine Fuel Feed Vent Hose USCG/SAE J1527 Type A2	102	Yes	Yes		
Marine Fuel Feed Vent Hose USCG/SAE J1527 Type B2	103	Yes	Yes		
Marine Fuel Line USCG/SAE J1527 & ISO 7840 Type A1	100	Yes	Yes		
Plicord® Hardwall Wet Exhaust	96-99		Yes	Yes	
Plicord® SAE J1527 Type A2 (fuel fill)	95	Yes	Yes	Yes	
Plicord® Softwall Wet Exhaust	98-99		Yes		Yes

# Plicord® SAE J1527 Type A2 Fuel Fill



## Product Specifications

### Application

The Plicord® SAE J1527 Type A2, ISO 7840 and CE Fuel Fill hose is for marine gasoline tanks. It is the connection from the boat's fuel fill port down to the boat's fuel tank.

### Construction Tube

Nitrile synthetic rubber RMA Class A (High Oil Resistance)

### Cover

Chemivic™ synthetic rubber (wrapped impression)

### Reinforcement

Spiral-plied synthetic fabric with wire helix

### Temperature Range

-20°F to 180°F (-29°C to 82°C)

### Packaging

50' exact length, coiled, and polywrapped

### Branding

Example: Continental ContiTech SAE J1527, USCG Type A2, ISO 7840

### Couplings

Contact fitting manufacturer for proper fitting recommendation and coupling procedure.

### Order Codes

543-414

## Plicord® SAE J1527 Type A2

SAP #	ID		Nom. OD		Max. WP		Vacuum HG		Weight	
	in.	mm	in.	mm	psi	MPa	in.	mm	lb./ft.	kg/m
20050850	1¼	31.8	1.70	43.2	100	0.69	29	737	0.68	1.01
20017852	1½	38.0	1.86	47.1	100	0.69	29	737	0.65	0.97
20017855	1⅞	47.6	2.30	58.4	100	0.69	29	737	0.96	1.43
20095640	2	50.8	2.43	61.7	50	0.34	29	737	1.01	1.50
20017857	2⅜	69.9	2.80	71.1	50	0.34	29	737	1.19	1.77

**Air & Multipurpose**  
General Purpose  
Heavy Duty  
Push-on

Chemical Transfer

Cleaning Equipment

**Food**  
Transfer  
Washdown

**Marine**

**Material Handling**  
Abrasives  
Bulk Transfer  
Cement & Concrete

Mining

**Petroleum**  
Aircraft Fueling  
Dispensing  
Dock  
Transfer

Spray

Steam

Vacuum

LPG Delivery

**Water**  
Discharge  
Suction & Discharge  
Washdown

Welding

Coupling Systems

Equipment

Appendix

# Plicord® Hardwall Wet Exhaust



## Product Specifications

### Application

For water suction and discharge applications including: engine intake, bilge exhaust, toilet, holding tank and scupper lines. Also for industrial water suction and discharge applications where unique sizes are required to fit over pipe. Does not meet SAE J2006 R2 Spec.\*

### Construction Tube

Black Nitrile synthetic rubber RMA Class A (High Oil Resistance)

### Cover

Black SBR synthetic rubber (wrapped impression)

### Reinforcement

Spiral-plyed synthetic fabric with wire helix

### Temperature Range

-20°F to 180°F (-29°C to 82°C)

\*Spec 542-812 (<6") and 541-812 (>6") meet the SAE J2006 R2 Spec but the tube is non-oil resistant (Class C Oil Resistance)

### Packaging

1/2"-5 1/2" - 50' exact length, coiled and polywrapped  
6"-8" - 25' exact length, polywrapped

### Branding (Spiral)

Example: Industrial ORS/Wet Exhaust Continental ContiTech

### Couplings

Contact fitting manufacturer for proper fitting recommendation and coupling procedure.

### Order Codes

543-193 (<6")

541-193 (>6")

#### Air & Multipurpose

General Purpose

Heavy Duty

Push-on

Chemical Transfer

Cleaning Equipment

#### Food

Transfer

Washdown

#### Marine

#### Material Handling

Abrasives

Bulk Transfer

Cement & Concrete

Mining

#### Petroleum

Aircraft Fueling

Dispensing

Dock

Transfer

Spray

Steam

Vacuum

LPG Delivery

#### Water

Discharge

Suction & Discharge

Washdown

Welding

Coupling Systems

Equipment

Appendix



**Plicord® Hardwall Wet Exhaust**

SAP #	ID	Nom. OD		Max. WP		Bend Radius		Vacuum HG		Weight		
		in.	mm	in.	mm	psi	MPa	in.	mm	in.	mm	lb./ft.
20142763	1/2	12.7	0.95	24.3	250	1.72	2	51	29	737	0.35	0.52
20149571	5/8	15.9	1.07	27.3	200	1.38	2	51	29	737	0.40	0.59
20133706	3/4	19.0	1.19	30.4	200	1.38	3	76	29	737	0.46	0.68
20142765	7/8	22.2	1.32	33.5	200	1.38	3	76	29	737	0.52	0.77
20129126	1	25.4	1.44	36.6	150	1.03	3	76	29	737	0.57	0.84
20138386	1 1/8	28.6	1.58	40.3	150	1.03	4	102	29	737	0.64	0.95
20107682	1 1/4	31.8	1.70	43.3	150	1.03	4	102	29	737	0.70	1.04
20123332	1 3/8	34.9	1.82	46.3	125	0.86	4	102	29	737	0.75	1.11
20123383	1 1/2	38.1	1.94	49.3	100	0.69	4	102	29	737	0.81	1.20
20142751	1 5/8	41.3	2.07	52.8	100	0.69	4	102	29	737	0.87	1.29
20123333	1 3/4	44.4	2.22	56.4	100	0.69	4	102	29	737	0.94	1.40
20105482	1 7/8	47.6	2.33	59.3	100	0.69	6	152	29	737	0.99	1.47
20123384	2	50.8	2.44	62.4	75	0.52	6	152	29	737	1.05	1.56
20107683	2 1/8	54.0	2.59	65.8	75	0.52	6	152	29	737	1.11	1.65
20138387	2 1/4	57.1	2.70	68.6	75	0.52	6	152	29	737	1.16	1.72
20140304	2 3/8	60.3	2.83	72.1	75	0.52	8	203	29	737	1.22	1.81
20107684	2 1/2	63.5	3.02	76.8	75	0.52	8	203	29	737	1.57	2.33
20135126	2 3/4	69.8	3.28	83.3	50	0.34	8	203	29	737	1.72	2.56
20139655	2 7/8	73.0	3.40	86.5	50	0.34	8	203	29	737	1.79	2.66
20123334	3	76.2	3.51	89.1	50	0.34	10	254	29	737	1.77	2.63
20107686	3 1/8	79.4	3.66	93.0	50	0.34	10	254	29	737	1.86	2.77
20135127	3 1/2	88.9	4.05	103.0	50	0.34	10	254	29	737	2.07	3.08
20142764	4	101.6	4.53	115.2	50	0.34	12	305	29	737	2.45	3.65
20278423	4 1/2	114.3	5.10	129.7	30	0.21	14	356	29	737	3.47	5.17
20274816	5	127.0	5.61	142.5	30	0.21	24	610	29	737	3.83	5.70
20183338	6	152.4	6.67	169.4	30	0.21	30	762	29	737	5.19	7.73
20344004	6 5/8	168.3	7.49	190.4	30	0.21	36	914	29	737	7.93	11.80
20183339	8	203.2	8.87	225.4	30	0.21	44	1118	29	737	8.92	13.20

Air & Multipurpose  
General Purpose  
Heavy Duty  
Push-on

Chemical Transfer

Cleaning Equipment

Food  
Transfer  
Washdown

Marine

Material Handling  
Abrasives  
Bulk Transfer  
Cement & Concrete

Mining

Petroleum  
Aircraft Fueling  
Dispensing  
Dock  
Transfer

Spray

Steam

Vacuum

LPG Delivery

Water  
Discharge  
Suction & Discharge  
Washdown

Welding

Coupling Systems

Equipment

Appendix

# Plicord® Softwall Wet Exhaust



## Product Specifications

### Application

For water discharge applications for engines, toilets, scuppers and bilge pumps. Will not part. Does not meet SAE J2006 R1 Spec.\*

### Construction Tube

Black Nitrile synthetic rubber RMA Class A (High Oil Resistance)

### Cover

Black Chemivic™ synthetic rubber (wrapped impression)

### Reinforcement

Spiral-plied synthetic fabric

### Temperature Range

-20°F to 180°F (-29°C to 82°C)

\*Spec 542-813 (<6") and 541-813 (>6") meet the SAE J2006 R1 Spec but the tube is non-oil resistant (Class C Oil Resistance)

### Packaging

25' exact lengths, coiled and polywrapped

### Branding (Spiral)

Example: Industrial ORS/Wet Exhaust Continental ContiTech

### Couplings

Contact fitting manufacturer for proper fitting recommendation and coupling procedure.

### Order Codes

543-154 (<6")

541-154 (>6")

**Air & Multipurpose**

General Purpose

Heavy Duty

Push-on

Chemical Transfer

Cleaning Equipment

**Food**

Transfer

Washdown

**Marine**

**Material Handling**

Abrasives

Bulk Transfer

Cement & Concrete

Mining

**Petroleum**

Aircraft Fueling

Dispensing

Dock

Transfer

Spray

Steam

Vacuum

LPG Delivery

**Water**

Discharge

Suction & Discharge

Washdown

Welding

Coupling Systems

Equipment

Appendix

**Plicord® Softwall Wet Exhaust**

SAP #	ID		Nom. OD		Max. WP		Weight	
	in.	mm	in.	mm	psi	MPa	lb./ft.	kg/m
20123258	1/2	12.7	0.94	23.9	250	1.72	0.29	0.43
20126043	3/4	19.0	1.18	30.0	200	1.38	0.26	0.38
20115943	7/8	22.2	1.30	33.2	200	1.38	0.44	0.65
20107027	1	25.4	1.43	36.3	150	1.03	0.48	0.71
20156178	1½	28.6	1.57	39.9	150	1.03	0.54	0.80
20113717	1¼	31.8	1.69	43.0	150	1.03	0.59	0.87
20107028	1½/16	33.3	1.75	44.5	125	0.86	0.64	0.90
20110836	1¾	34.9	1.81	46.0	125	0.86	0.64	0.95
20107029	1½	38.1	1.92	49.0	100	0.62	0.62	0.92
20107050	1¾	41.3	2.06	52.5	100	0.69	0.74	1.10
20108751	1¾	44.4	2.20	56.0	100	0.69	0.80	1.19
20115942	1¾	47.6	2.32	59.0	100	0.69	0.84	1.25
20107025	2	50.8	2.51	63.7	75	0.52	1.04	1.54
20137213	2¼	54.0	2.64	67.1	75	0.52	1.10	1.63
20105483	2¼	57.1	2.75	69.9	75	0.52	1.15	1.71
20105484	2¾	60.3	2.94	74.7	75	0.52	1.35	2.01
20107080	2½	63.5	3.05	77.6	75	0.52	1.41	2.10
20107081	2¾	73.0	3.44	87.4	75	0.52	1.61	2.31
20105485	3	76.2	3.54	90.1	50	0.34	1.66	2.47
20137215	3¼	79.4	3.70	94.0	50	0.34	1.74	2.59
20107082	3½	88.9	4.09	109.0	50	0.34	1.94	2.89
20110837	4	101.6	4.57	116.1	50	0.34	2.18	3.24
20110838	4½	114.3	5.06	128.6	30	0.21	2.43	3.62
20118697	5	127.0	5.56	141.3	30	0.21	2.68	3.99
20137217	5½	139.7	6.09	154.8	30	0.21	2.94	4.38
20114451	6	152.4	6.56	166.6	30	0.21	3.19	4.75
20126042	6¾	168.3	7.37	187.3	30	0.21	4.78	7.12

**Air & Multipurpose**  
General Purpose  
Heavy Duty  
Push-on

Chemical Transfer

Cleaning Equipment

**Food**  
Transfer  
Washdown

Marine

**Material Handling**  
Abrasives  
Bulk Transfer  
Cement & Concrete

Mining

**Petroleum**  
Aircraft Fueling  
Dispensing  
Dock  
Transfer

Spray

Steam

Vacuum

LPG Delivery

**Water**  
Discharge  
Suction & Discharge  
Washdown

Welding

Coupling Systems

Equipment

Appendix

# Marine Fuel Line USCG/SAE J1527 & ISO 7840 Type A1



## Product Specifications

### Application

For marine gasoline tanks. For fuel feed and vent applications on marine pleasure craft. It meets U.S. Coast Guard and International Marine Certification Institute requirements for type A1 service.

### Construction Tube

Black Nitrile synthetic rubber RMA Class A (High Oil Resistance)

### Cover

Black Chemivic™ synthetic rubber

### Reinforcement

Spiral synthetic yarn

### Temperature Range

0°F to 115°F (-17°C to 46°C)

### Packaging

200' reels, maximum 3 pieces, increments of 50'

### Branding

Example: Continental ContiTech USCG/SAE J 1527 Type A1 ISO 7840-A1 CE

### Couplings

Contact fitting manufacturer for proper fitting recommendation and coupling procedure.

### Order Codes

595-032

## Marine Fuel Line SAE J1527 Type A1

SAP #	ID		Nom. OD		Max. WP		Weight	
	in.	mm	in.	mm	psi	MPa	lb./ft.	kg/m
20069186	1/4	6.4	0.65	16.5	49	0.34	0.17	0.25
20069187	5/16	7.9	0.71	18.0	49	0.34	0.19	0.28
20069188	3/8	9.5	0.78	19.8	49	0.34	0.20	0.30
20028994	1/2	12.7	0.89	23.0	36	0.25	0.26	0.39
20106800	5/8	15.9	1.06	25.8	36	0.25	0.35	0.52

Air & Multipurpose  
General Purpose  
Heavy Duty  
Push-on

Chemical Transfer

Cleaning Equipment

Food  
Transfer  
Washdown

Marine

Material Handling  
Abrasives  
Bulk Transfer  
Cement & Concrete

Mining

Petroleum  
Aircraft Fueling  
Dispensing  
Dock  
Transfer

Spray

Steam

Vacuum

LPG Delivery

Water  
Discharge  
Suction & Discharge  
Washdown

Welding

Coupling Systems

Equipment

Appendix

# Flexshield™ SAE J1527 USCG Type A1-15 / ISO 7840 Marine Barrier Hose



## Product Specifications

### Application

Designed for marine gasoline tanks for fuel feed and vent applications on marine pleasure craft. Barrier style construction meets new EPA requirements for low permeation class A1-15 marine fuel lines. Fire resistant cover provides minimum 2½ minute fire resistivity for USCG type A service.

### Construction Tube

Black Chemivic™ synthetic rubber

### Cover

Nitrile synthetic rubber

### Reinforcement

Polyester spiral with nylon barrier

### Temperature Range

-20°F to 180°F (-29°C to 82°C)

### Packaging

Reels

### Branding

Example: Flexshield™ 5412 3/8" SAE J1527 USCG Type A1-15 / ISO 7840-A1 CE Continental ContiTech

### Couplings

Contact fitting manufacturer for proper fitting recommendation and coupling procedure.

### Non-Stock/Sizes

Contact a Continental ContiTech representative for special production run minimum requirements and private label options.

### Order Codes

1/4" - 475-412-008  
 5/16" - 475-412-010  
 3/8" - 475-412-012  
 1/2" - 475-412-016

## Flexshield™ SAE J1527 Type A1-15

SAP #	ID		Nom. OD		Weight		Min. Burst	
	in.	mm	in.	mm	lb./ft.	kg/m	psi	bar
20464766	1/4	5.95	0.627	15.92	0.15	0.23	250	17.2
20464768	5/16	7.54	0.658	16.71	0.16	0.24	250	17.2
20464769	3/8	9.12	0.725	18.41	0.20	0.30	250	17.2

Air & Multipurpose  
 General Purpose  
 Heavy Duty  
 Push-on

Chemical Transfer

Cleaning Equipment

Food  
 Transfer  
 Washdown

Marine

Material Handling  
 Abrasives  
 Bulk Transfer  
 Cement & Concrete

Mining

Petroleum  
 Aircraft Fueling  
 Dispensing  
 Dock  
 Transfer

Spray

Steam

Vacuum

LPG Delivery

Water  
 Discharge  
 Suction & Discharge  
 Washdown

Welding

Coupling Systems

Equipment

Appendix

# Marine Fuel Feed Vent Hose USCG/ SAE J1527 Type A2 Fire Retardant



## Product Specifications

### Application

For fuel feed and vent application on marine pleasure craft.

### Packaging

500'-750' reels, maximum 3 pieces, minimum length 35'

### Construction Tube

Black Nitrile synthetic rubber RMA Class A (High Oil Resistance)

### Branding (Spiral)

Example: Continental ContiTech USCG/SAE J 1527 Type A2

### Cover

Gray Chemivic™ synthetic rubber

### Couplings

Contact fitting manufacturer for proper fitting recommendation and coupling procedure.

### Reinforcement

Spiral synthetic yarn

### Order Codes

595-022

### Temperature Range

0°F to 115°F (-18°C to 46°C)

## Marine Fuel Feed Vent Hose Type A2

ID	Nom. OD		Max. WP		Weight		
	in.	mm	in.	mm	psi	MPa	lb./ft.
1/4	6.4	0.66	16.8	35	0.24	0.19	0.28
5/16	7.9	0.72	18.3	35	0.24	0.22	0.33
3/8	9.5	0.78	19.8	35	0.24	0.24	0.36
1/2	12.7	0.91	23.1	35	0.24	0.3	0.45
5/8	15.9	0.96	25.8	35	0.24	0.34	0.51

Air &amp; Multipurpose

General Purpose

Heavy Duty

Push-on

Chemical Transfer

Cleaning Equipment

Food

Transfer

Washdown

Marine

Material Handling

Abrasives

Bulk Transfer

Cement &amp; Concrete

Mining

Petroleum

Aircraft Fueling

Dispensing

Dock

Transfer

Spray

Steam

Vacuum

LPG Delivery

Water

Discharge

Suction &amp; Discharge

Washdown

Welding

Coupling Systems

Equipment

Appendix

# Marine Fuel Feed Vent Hose USCG/SAE J1527 Type B2 Non-Fire Retardant



## Product Specifications

### Application

For fuel feed and vent application on marine pleasure craft.

### Construction Tube

Nitrile synthetic rubber RMA Class A (High Oil Resistance)

### Cover

Gray Chemivic™ synthetic rubber

### Reinforcement

Spiral synthetic yarn

### Temperature Range

0°F to 115°F (-18°C to 46°C)

### Packaging

500'-750', maximum 3 pieces, minimum length 35'

### Branding

Example: Continental ContiTech USCG/SAE J 1527 Type B2.

### Couplings

Contact fitting manufacturer for proper fitting recommendation and coupling procedure.

### Order Codes

595-009

## Marine Fuel Feed Vent Hose Type B2

SAP #	ID		Nom. OD		Max. WP		Weight	
	in.	mm	in.	mm	psi	MPa	lb./ft.	kg/m
Gray	1/4	6.4	0.58	14.7	34	0.23	0.12	0.18
	5/16	7.9	0.66	16.8	34	0.23	0.15	0.22
20028805	3/8	9.5	0.70	17.8	34	0.23	0.16	0.24
	1/2	12.7	0.81	20.6	34	0.23	0.18	0.27
20028810	5/8	15.9	0.96	24.4	34	0.23	0.19	0.28

Air & Multipurpose  
General Purpose  
Heavy Duty  
Push-on

Chemical Transfer

Cleaning Equipment

Food  
Transfer  
Washdown

Marine

Material Handling  
Abrasives  
Bulk Transfer  
Cement & Concrete

Mining

Petroleum  
Aircraft Fueling  
Dispensing  
Dock  
Transfer

Spray

Steam

Vacuum

LPG Delivery

Water  
Discharge  
Suction & Discharge  
Washdown

Welding

Coupling Systems

Equipment

Appendix

# Abrasives



**Air & Multipurpose**  
 General Purpose  
 Heavy Duty  
 Push-on

Chemical Transfer

Cleaning Equipment

**Food**  
 Transfer  
 Washdown

Marine

**Material Handling**  
 Abrasives  
 Bulk Transfer  
 Cement & Concrete

Mining

**Petroleum**  
 Aircraft Fueling  
 Dispensing  
 Dock  
 Transfer

Spray

Steam

Vacuum

LPG Delivery

**Water**  
 Discharge  
 Suction & Discharge  
 Washdown

Welding

Coupling Systems

Equipment

Appendix

	Page	Food Grade	Clear	Static Dissipating/ Static Conductive Tube	Temp. Range	Static Wire	Thermo-plastic	Rubber
Artrac	111			Yes	-40°F to 158°F (-40°C to 70°C)		Yes	
Arvac SW	110				-40°F to 158°F (-40°C to 70°C)	Yes	Yes	
Blucor	108			Yes*	-25°F to 180°F (-32°C to 82°C)			Yes
Blucor Couplings	109							
Diversiflex	112			Yes*	-25°F to 180°F (-32°C to 82°C)			Yes
Diversipipe 75	113			Yes*	-40°F to 180°F (-40°C to 82°C)			Yes
Diversipipe 150	114			Yes*	-40°F to 180°F (-40°C to 82°C)			Yes
Flexible Downspout	115				-25°F to 180°F (-32°C to 82°C)			Yes
Nutriflex Static Wire	72	Yes	Yes		-15°F to 158°F (-26°C to 70°C)	Yes	Yes	
Plicord Blast	106			Yes	-25°F to 180°F (-32°C to 82°C)			Yes
Plicord Dredge Sleeve	117			Yes	-25°F to 180°F (-32°C to 82°C)			Yes
Plicord Hydrovator	116			Yes	-25°F to 180°F (-32°C to 82°C)			Yes
Plicord RVC	118				-20°F to 180°F (-29°C to 82°C)			Yes
Plicord Sand Suction	119			Yes	-25°F to 180°F (-32°C to 82°C)			Yes
Plicord XF Blast	107			Yes	-25°F to 180°F (-32°C to 82°C)			Yes
Sandblast Deadman	105				-20°F to 190°F (-29°C to 88°C)			Yes
Spiraflex Air Seeder	120		Yes		0°F to 158°F (-18°C to 70°C)			
Spirathane HD	121				0°F to 158°F (-18°C to 70°C)		Yes	
Spirathane LD	123		Yes		0°F to 158°F (-18°C to 70°C)		Yes	
Spirathane PT	122	Yes	Yes		0°F to 158°F (-18°C to 70°C)	Yes	Yes	



# Sandblast Deadman



## Product Specifications

### Application

Double Line Sandblast Deadman hose is for use with systems for the automatic shut-off of sandblasting equipment at the operator end of the system. Used in a pneumatic closed circuit pattern, deadman hose is connected to air-actuated shut valves which, in turn, are controlled at all times by the sandblast operator via a "deadman" switch at the nozzle end of the sandblast hose.

### Construction Tube

Premium-quality EPDM synthetic rubber, RMA Class C (Limited Oil Resistance)

### Cover

Yellow/Yellow EPDM, RMA Class C (Limited Oil Resistance)

### Reinforcement

Spiral-plied synthetic yarn

### Temperature Range

-20°F to 190°F (-29°C to 88°C)

### Packaging

450'-750' reels, maximum 2 pieces, minimum length 25'

### Branding

Continuous brand 3/16" ID (4.8mm) Sandblast Deadman. Made in U.S.A. Continental ContiTech

### Couplings

Contact fitting manufacturer for proper fitting recommendation and coupling procedure.

### Order Codes

- 569-595 Yellow/Yellow
- 569-616 Red/Blue
- 569-627 Black/Yellow
- 569-676 Red/Black
- 569-696 Yellow/Gray
- 569-628 Blue/Blue

## Sandblast Deadman

SAP #		ID			Nom. OD		Max. WP		Weight			
Yellow/ Yellow	Black/ Yellow	Red/Black	Yellow/ Gray	Blue/Blue	in.	mm	in.	mm	psi	MPa	lb./ft.	kg/m
20027303	20266436	20709610	20646905	20658279	3/16	4.8	0.44	11.2	200	1.38	0.14	0.21

**Air & Multipurpose**  
General Purpose  
Heavy Duty  
Push-on

Chemical Transfer

Cleaning Equipment

**Food**  
Transfer  
Washdown

Marine

**Material Handling**  
Abrasives  
Bulk Transfer  
Cement & Concrete

Mining

**Petroleum**  
Aircraft Fueling  
Dispensing  
Dock  
Transfer

Spray

Steam

Vacuum

LPG Delivery

**Water**  
Discharge  
Suction & Discharge  
Washdown

Welding

Coupling Systems

Equipment

Appendix

# Plicord® Blast



## Product Specifications

### Application

Heavy-duty hose for steel shot or sand blasting in cleaning or finishing metal, stone, glass or other surfaces.

### Construction Tube

ChemiTuf® synthetic rubber (static dissipating/static conductive)

### Cover

2 ply: Black SBR synthetic rubber (wrapped impression)  
4 ply: Green SBR synthetic rubber (wrapped impression)

### Reinforcement

Spiral-plied synthetic fabric

### Temperature Range

-25°F to 180°F (-32°C to 82°C)

### Packaging

50' lengths, coiled and polywrapped

### Branding (Spiral)

Example: Continental ContiTech Plicord® Blast 150 psi WP

### Couplings

Contact fitting manufacturer for proper fitting recommendation and coupling procedure.

### Plicord® Blast (2 Ply)

Order Codes: 549-020, Survivor 549-805

SAP #	ID	Nom. OD		Max. WP		Weight			
Black	Survivor Compound	in.	mm	in.	mm	psi	MPa	lb./ft.	kg/m
20018947	20673581	1/2	12.7	1.13	28.7	150	1.03	0.41	0.61
20018954	20678582	3/4	19.1	1.48	37.6	150	1.03	0.68	1.01
20018963	20673583	1	25.4	1.88	47.8	150	1.03	1.05	1.56
20018972	20678584	1¼	31.8	2.16	54.9	150	1.03	1.26	1.88
20018982	20673585	1½	38.1	2.38	60.5	150	1.03	1.42	2.11
20018993	20677610	2	50.8	2.86	72.6	150	1.03	1.70	2.53

### Plicord® Blast (4 Ply)

Order Codes: 549-027

SAP #	ID	Nom. OD		Max. WP		Weight		
Green	in.	mm	in.	mm	psi	MPa	lb./ft.	kg/m
20031672	1/2	12.7	1.14	26.7	150	1.03	0.44	0.61
20019031	3/4	19.1	1.50	38.1	150	1.03	0.71	1.06
20019033	1	25.4	1.88	47.8	150	1.03	1.08	1.61
20019037	1¼	31.8	2.16	54.9	150	1.03	1.31	1.95
20019040	1½	38.1	2.38	60.5	150	1.03	1.45	2.16
20019043	2	50.8	2.88	73.2	150	1.03	1.75	2.60

**Air & Multipurpose**  
General Purpose  
Heavy Duty  
Push-on

Chemical Transfer

Cleaning Equipment

**Food**  
Transfer  
Washdown

Marine

**Material Handling**  
Abrasives  
Bulk Transfer  
Cement & Concrete

Mining

**Petroleum**  
Aircraft Fueling  
Dispensing  
Dock  
Transfer

Spray

Steam

Vacuum

LPG Delivery

**Water**  
Discharge  
Suction & Discharge  
Washdown

Welding

Coupling Systems

Equipment

Appendix

# Plicord® XF Blast



## Product Specifications

### Application

Standard-duty hose for steel shot or sand blasting in cleaning or finishing metal, stone, glass or other surfaces.

### Construction Tube

ChemiTuf® synthetic rubber (static dissipating/static conductive)

### Cover

Black SBR synthetic rubber (static dissipating/static conductive) (wrapped impression)

### Reinforcement

Spiral-plied synthetic fabric

### Temperature Range

-25°F to 180°F (-32°C to 82°C)

### Packaging

50' lengths, coiled and polywrapped

### Branding (Spiral)

Example: Continental ContiTech Plicord® XF Blast 150 psi WP

### Couplings

Contact fitting manufacturer for proper fitting recommendation and coupling procedure.

### Plicord® XF Blast (2 Ply)

Order Codes: 549-018

SAP #	ID		Nom. OD		Max. WP		Weight	
	in.	mm	in.	mm	psi	MPa	lb./ft.	kg/m
20018907	5/8	15.9	1.13	28.7	150	1.03	0.37	0.55
20018911	7/8	22.2	1.51	38.4	150	1.03	0.61	0.91
20018913	1 1/8	28.6	1.88	47.8	150	1.03	0.92	1.37
20018916	1 3/8	34.9	2.15	54.6	150	1.03	1.12	1.67
20018920	1 5/8	41.3	2.38	60.5	150	1.03	1.21	1.80
20018924	2 1/8	54.0	2.89	73.4	150	1.03	1.53	2.28

### Plicord® XF Blast (4 Ply)

Order Codes: 549-019

SAP #	ID		Nom. OD		Max. WP		Weight	
	in.	mm	in.	mm	psi	MPa	lb./ft.	kg/m
20018925	5/8	15.9	1.12	28.5	150	1.03	0.35	0.52
20018927	7/8	22.2	1.50	38.1	150	1.03	0.71	1.06
20018929	1 1/8	28.6	1.88	47.8	150	1.03	0.93	1.38
20018933	1 3/8	34.9	2.16	54.9	150	1.03	1.11	1.65
20018938	1 5/8	41.3	2.38	60.5	150	1.03	1.23	1.83
20018943	2 1/8	54.0	2.88	73.2	150	1.03	1.48	2.20

**Air & Multipurpose**  
General Purpose  
Heavy Duty  
Push-on

Chemical Transfer

Cleaning Equipment

**Food**  
Transfer  
Washdown

Marine

**Material Handling**  
Abrasives  
Bulk Transfer  
Cement & Concrete

Mining

**Petroleum**  
Aircraft Fueling  
Dispensing  
Dock  
Transfer

Spray

Steam

Vacuum

LPG Delivery

**Water**  
Discharge  
Suction & Discharge  
Washdown

Welding

Coupling Systems

Equipment

Appendix

# Blucor™



## Product Specifications

### Application

Blucor™ material handling hose with the Continental ContiTech 150 psi bolt-on split flange coupling is an easy and economical choice. Blucor™ has the high strength needed to handle pressure or suction service in the transfer of dry bulk, slurry, salt, cement, fertilizers and a limited quantity of oil-based products.

### Construction Tube

3/8" Black Pureten™, 3/8" Black ChemiTuf® (static dissipating/static conductive), or 3/8" Tan Pureten™

### Cover

Black corrugated abrasion-resistant SBR (wrapped impression)

### Reinforcement

Spiral-plied synthetic fabric with wire helix

### Temperature Range

-25°F to 180°F (-32°C to 82°C)

### Packaging

3"-8" - Coiled or straight, polywrapped  
10"-16" - Straight, polywrapped

### Branding (Spiral)

Example: Continental ContiTech Blucor™ Black Pureten™ Liner

### Couplings

Blucor™ bolt-on split flange couplings, see next page.

### Non-Stock/Sizes

Maximum shipping length: 3"-8": 100 ft.; 10", 12" & 16": 50 ft.

### Order Codes

541-789 (black Pureten™)  
541-458 (tan Pureten™)  
541-788 (black ChemiTuf®)  
541-934 (Survivor)

## Blucor™

SAP #		ID		Nom. OD		Max. Bend WP		Radius		Vacuum HG		Weight		
Black Pureten	Tan Pureten	Black Tufysn	W/ Survivor Compound	in.	mm	in.	mm	psi	in.	mm	in.	mm	lb./ft.	kg/m
20016075	20727995	20174317	20677611	3	76.2	4.39	111.5	150	16	406	29	737	4.63	6.89
20016084	20015583	20472262	20606370	4	101.6	5.25	133.4	150	20	508	29	737	5.67	8.44
20016105	20015584	20016070	20673534	6	152.4	7.37	187.2	150	36	914	29	737	9.48	14.11
20016127	20091843	20616942	20710232	8	203.2	9.44	239.8	150	48	1219	29	737	14.20	21.13
20016144	20015585	20099997	20548906	10	254.0	11.38	289.1	150	60	1524	29	737	16.63	24.75
20032306	20015586	20050994		12	304.8	13.81	350.8	100	72	1829	29	737	23.40	34.82
20562563		20693889	20766664	16	407.8	18.30	464.8	100	96	2438	29	737	40.60	

Air & Multipurpose  
General Purpose  
Heavy Duty  
Push-on

Chemical Transfer

Cleaning Equipment

Food  
Transfer  
Washdown

Marine

Material Handling  
Abrasives  
Bulk Transfer  
Cement & Concrete

Mining

Petroleum  
Aircraft Fueling  
Dispensing  
Dock  
Transfer

Spray

Steam

Vacuum

LPG Delivery

Water  
Discharge  
Suction & Discharge  
Washdown

Welding

Coupling Systems

Equipment

Appendix

# Blucor™ Couplings

## Bolt-On Split Flange Couplings



### Product Specifications

#### Specifications

Each fitting is manufactured of high-tensile 432 aluminum alloy. All flanges are 150 lbs. ANSI B16.5. Bolt-on split flange couplings are supplied with necessary mounting hardware (bolts, nuts and washers). Internal configurations of fitting corrugations have been designed specifically to match the corrugation of the Blucor™ hose.

#### Order Codes

604-189

#### Blucor™ Couplings

SAP #	ID		Nom. OD		Weight	
	in.	mm	in.	mm	lb./ft.	kg/m
20021516	3	76.2	7.5	190.5	3.6	5.36
20021517	4	101.6	9.0	228.6	4.0	5.95
20021518	6	152.4	11.0	279.4	8.2	12.20
20021519	8	203.2	13.5	342.9	14.0	20.83
20021520	10	254.0	16.0	406.4	25.0	37.20
20021521	12	304.8	19.0	482.6	30.0	44.64

Air & Multipurpose  
General Purpose  
Heavy Duty  
Push-on

Chemical Transfer

Cleaning Equipment

Food  
Transfer  
Washdown

Marine

**Material Handling**  
Abrasives  
Bulk Transfer  
Cement & Concrete

Mining

Petroleum  
Aircraft Fueling  
Dispensing  
Dock  
Transfer

Spray

Steam

Vacuum

LPG Delivery

Water  
Discharge  
Suction & Discharge  
Washdown

Welding

Coupling Systems

Equipment

Appendix

# Arvac™ SW



## Product Specifications

### Application

Heavy-duty abrasion-resistant suction hose used for a variety of abrasive material-handling applications, including the transfer of sand, gravel, cement, fly ash, glass, metals, plastic pellets, fertilizers, rock salts and slurries. Static wire for static dissipation.

### Construction Tube

Higher-temperature urethane

### Cover

Static-dissipating thermoplastic alloyed blend of nitrile, polyurethane and PVC

### Reinforcement

Rigid high-density PVC helix

### Temperature Range

-40°F to 158°F (-40°C to 70°C)

### Packaging

1¼"-6" - 20' lengths, polytube  
 100' lengths, coiled and polywrapped  
 8"-10" - 20', 40', 50' lengths, polytube

### Branding

Not branded

### Couplings

Contact fitting manufacturer for proper fitting recommendation and coupling procedure.

### Non-Stock/Sizes

Contact Continental ContiTech for special production run minimum requirements.

### Order Codes

586-550

## Arvac™ SW

SAP #	ID	Nom. OD		Max. WP		Weight		Vacuum HG		Bend Radius		Length	
		in.	mm	in.	mm	psi	MPa	lb./ft.	kg/m	in.	mm		
<b>Black</b>	<b>in.</b>	<b>mm</b>	<b>in.</b>	<b>mm</b>	<b>psi</b>	<b>MPa</b>	<b>lb./ft.</b>	<b>kg/m</b>	<b>in.</b>	<b>mm</b>	<b>in.</b>	<b>mm</b>	<b>ft.</b>
20448195	1¼	31.8	1.60	40.7	45	0.31	0.35	0.52	29	737	3.0	76	100
20448194	1½	38.1	1.87	47.4	40	0.28	0.39	0.58	29	737	3.0	76	100
20448193	2	50.8	2.46	62.5	40	0.28	0.67	0.99	29	737	2.5	63	100
20448192	2½	63.5	3.03	77.0	35	0.24	0.90	1.33	29	737	4.0	101	100
20448191	3	76.2	3.60	91.5	30	0.21	1.17	1.73	29	737	6.0	152	100
20448190	4	101.6	4.74	120.5	30	0.21	1.97	2.91	29	737	7.0	177	100
20447689	5	127.0	5.81	147.5	30	0.21	2.58	3.82	29	737	8.0	203	100
20452698	6	152.4	6.89	175.0	25	0.17	3.32	4.91	29	737	8.0	203	20
20452697	6	152.4	6.89	175.0	25	0.17	3.32	4.91	29	737	8.0	203	50
20447688	6	152.4	6.89	175.0	25	0.17	3.32	4.91	29	737	8.0	203	100
20447687	8	203.2	9.13	232.0	20	0.14	5.66	8.38	29	737	18.0	456	20
20450354	8	203.2	9.13	232.0	20	0.14	5.66	8.38	29	737	18.0	456	50
20447686	10	254.0	11.16	283.5	20	0.14	7.86	11.63	29	737	36.0	912	20
20460651	10	254.0	11.16	283.5	20	0.14	7.86	11.63	29	737	36.0	912	40

# Artrac®



## Product Specifications

### Application

The Artrac® hose is used for a variety of abrasive, material-handling applications to transfer sand, gravel, cement, fly ash, glass, metals, plastic pellets, fertilizers, rock salts and slurries.

### Construction Tube

Thermoplastic alloyed blend of polyurethane and PVC (static dissipating/static conductive)

### Cover

Thermoplastic alloyed blend of nitrile, polyurethane, and PVC (non-conductive) (Available with conductive cover - see order code below.)

### Reinforcement

Rigid high-density PVC helix

### Temperature Range

-40°F to 158°F (-40°C to 70°C)

### Packaging

1¼"-6" - 100' lengths, coiled and polywrapped  
8"-10" - 20' lengths, polytube

### Branding

Not branded

### Couplings

Contact fitting manufacturer for proper fitting recommendation and coupling procedure.

### Non-Stock/Sizes

Contact customer service

### Order Codes

586-462  
586-522 (with conductive cover)

## Artrac® Abrasive Material Handling

SAP #	ID	Nom. OD		Max. WP		Bend Radius		Vacuum HG		Weight			
Black	w/ Conductive Cove	in.	mm	in.	mm	psi	MPa	in.	mm	in.	mm	lb./ft.	kg/m
20013527		1¼	31.8	1.63	41.4	45	0.31	3.0	76	29	737	0.34	0.51
20013528	20762598	1½	38.1	1.89	48.0	40	0.28	3.0	76	29	737	0.40	0.60
20013529	20762599	2	50.8	2.47	62.7	40	0.28	2.5	63	29	737	0.67	1.00
20013531		2½	63.5	3.05	77.5	35	0.24	4.0	101	29	737	0.87	1.29
20013532	20358269	3	76.2	3.69	93.7	30	0.21	6.0	152	29	737	1.16	1.73
20013535	20247316	4	101.6	4.81	122.2	30	0.21	7.0	177	29	737	2.16	3.21
20013539		5	127.0	5.78	146.8	30	0.21	8.0	203	29	737	2.60	3.87
20013545	20247315	6	152.4	7.08	179.8	25	0.17	8.0	203	29	737	3.43	5.10
20013552		8	203.2	9.22	234.2	20	0.14	18.0	456	29	737	5.84	8.69
20013554		10	254.0	11.21	284.7	20	0.14	36.0	912	29	737	7.96	11.85

**Air & Multipurpose**  
General Purpose  
Heavy Duty  
Push-on

Chemical Transfer

Cleaning Equipment

**Food**  
Transfer  
Washdown

Marine

**Material Handling**  
Abrasives  
Bulk Transfer  
Cement & Concrete

Mining

**Petroleum**  
Aircraft Fueling  
Dispensing  
Dock  
Transfer

Spray

Steam

Vacuum

LPG Delivery

**Water**  
Discharge  
Suction & Discharge  
Washdown

Welding

Coupling Systems

Equipment

Appendix

# Diversiflex™



## Product Specifications

### Application

Provides the high strength needed to handle pressure or suction service in the movement of non-oily dry bulk materials such as salt, cement, fertilizers and dry chemicals. Typical applications include unloading hoppers to rail cars or barges and transferring materials from rail cars or barges to storage units.

### Construction Tube

1/4" Black ChemiTuf® synthetic rubber for abrasion resistance (static dissipating/static conductive)

### Cover

Abrasion-resistant SBR synthetic rubber (corrugated surface) (wrapped impression)

### Reinforcement

Spiral-plied synthetic fabric with wire helix

### Temperature Range

-25°F to 180°F (-32°C to 82°C)

### Packaging

Polywrapped

### Branding

Example: Continental ContiTech Plicord® Diversiflex™ Hose 75 psi Max WP

### Couplings

Contact fitting manufacturer for proper fitting recommendation and coupling procedure.

### Non-Stock/Sizes

Available up to 18" ID

### Order Codes

541-400

## Diversiflex™

SAP #	ID		Nom. OD		Max. WP		Bend Radius		Vacuum HG		Weight	
	in.	mm	in.	mm	psi	MPa	in.	mm	in.	mm	lb./ft.	kg/m
20212864	4	101.6	4.88	124.0	75	0.52	20	508	29	737	3.43	5.10
20116642	5	127.0	6.25	158.5	75	0.52	25	635	29	737	6.32	9.41
20325641	6	152.4	6.92	175.8	75	0.52	36	914	29	737	5.84	8.69
20268121	6 5/8	168.3	7.60	193.0	75	0.52	40	1016	29	737	7.04	10.48
20015474	8	203.2	9.05	229.9	75	0.52	48	1219	29	737	9.22	13.72
20031577	8 5/8	219.2	9.69	246.1	75	0.52	52	1321	29	737	10.82	16.10
20316082	10	254.0	11.04	280.4	75	0.52	60	1524	29	737	12.04	17.92
20587462	12	304.8	13.16	334.3	75	0.52	72	1829	29	737	16.38	24.38
20646669	12 3/4	323.9	13.91	353.3	75	0.52	77	1956	29	737	17.78	26.46

Air & Multipurpose

General Purpose

Heavy Duty

Push-on

Chemical Transfer

Cleaning Equipment

Food

Transfer

Washdown

Marine

Material Handling

Abrasives

Bulk Transfer

Cement & Concrete

Mining

Petroleum

Aircraft Fueling

Dispensing

Dock

Transfer

Spray

Steam

Vacuum

LPG Delivery

Water

Discharge

Suction & Discharge

Washdown

Welding

Coupling Systems

Equipment

Appendix



# Diversipipe® 75



## Product Specifications

### Application

A high-quality flexible hose for replacing cast iron pipes for the transfer of abrasive materials or corrosive chemicals where installation requires minimum bends or where the inherent flexibility of a durable rubber hose is required. Diversipipe® is also available in a softwall construction for discharge service.

### Construction Tube

Black ChemiTuf® synthetic rubber (static dissipating/static conductive) for slurry and dry bulk transfer, black Pureten™ for slurry, tan Pureten™ for slurry with high kinetic energy

### Cover

SBR synthetic rubber (wrapped impression)

### Reinforcement

Spiral-plied synthetic fabric with wire helix

### Temperature Range

-40°F to 180°F (-40°C to 82°C)

### Packaging

Polywrapped

### Branding

Example: Continental ContiTech Plicord® Material Handling Hose, 75 psi Max WP

### Couplings

Contact fitting manufacturer for proper fitting recommendation and coupling procedure.

### Non-Stock/Sizes

Available up to 18" ID

### Order Codes

Black ChemiTuf®: 541-047 (1/4" tube gauge)  
 541-044\* (3/8" tube gauge)  
 541-050\* (1/2" tube gauge)  
 Black Pureten™: 541-731 (1/4" tube gauge)  
 Tan Pureten™: 541-335 (1/4" tube gauge)  
 541-353\* (3/8" tube gauge)

## Diversipipe® 75

SAP #			ID		Nom. OD		Max. WP		Bend Radius		Vacuum HG		Weight	
(1/4)	(1/4)	(3/8)	in.	mm	in.	mm	psi	MPa	in.	mm	in.	mm	lb./ft.	kg/m
20469185		20609650	2	50.8	2.91	73.9	75	0.52	12	304.80	29	736.6	1.98	2.95
20258672			2½	63.5	3.39	86.1	75	0.52	15	381.00	29	736.6	2.44	3.64
20308540		20015308	3	76.2	3.89	98.8	75	0.52	18	457.20	29	736.6	2.99	4.46
20269761	20613574	20015309	4	101.6	4.91	124.7	75	0.52	24	609.60	29	736.6	3.79	5.65
20014880	20320682	20015310	4½	114.3	5.50	139.7	75	0.52	27	685.80	29	736.6	4.74	7.06
20269636			5	127.0	6.44	163.6	75	0.52	30	762.00	29	736.6	5.48	8.17
20421310	20015288	20015313	6	152.4	7.13	181.1	75	0.52	36	914.40	29	736.6	7.33	10.92
20268296	20015290		6⅝	168.3	7.78	197.6	75	0.52	39.7	1009.65	29	736.6	8.36	12.46
20472389	20015291	20015315	8	203.2	9.19	233.4	75	0.52	48	1219.20	29	736.6	10.48	15.62
		20731114	8⅝	219.1	9.75	247.6	75	0.52	51.75	1314.45	29	736.6	11.43	17.03
20048941			10	254.0	11.23	285.2	75	0.52	60	1524.00	29	736.6	14.83	22.10
20048942	20322091		12	304.8	13.31	338.1	75	0.52	72	1828.80	29	736.6	18.16	27.06

\*Note: 3/8" and 1/2" tube gauge specs available on request. Contact Customer Service.

**Air & Multipurpose**  
 General Purpose  
 Heavy Duty  
 Push-on

Chemical Transfer

Cleaning Equipment

**Food**  
 Transfer  
 Washdown

Marine

**Material Handling**  
 Abrasives  
 Bulk Transfer  
 Cement & Concrete

Mining

**Petroleum**  
 Aircraft Fueling  
 Dispensing  
 Dock  
 Transfer

Spray

Steam

Vacuum

LPG Delivery

**Water**  
 Discharge  
 Suction & Discharge  
 Washdown

Welding

Coupling Systems

Equipment

Appendix

# Diversipipe® 150



## Product Specifications

### Application

A high-quality flexible hose for replacing cast iron pipes for the transfer of abrasive materials or corrosive chemicals where installation requires minimum bends or where the inherent flexibility of a durable rubber hose is required. Diversipipe® is also available in a softwall construction for a discharge service.

### Construction Tube

Black ChemiTuf® (static dissipating/static conductive) for slurry and dry bulk transfer, black Pureten™ for slurry, tan Pureten™ for slurry with high kinetic energy

### Cover

SBR synthetic rubber (wrapped impression)

### Reinforcement

Spiral-plied synthetic fabric with wire helix

### Temperature Range

-40°F to 180°F (-40°C to 82°C)

### Packaging

Polywrapped

### Branding

Example: Continental ContiTech Plicord® Material Handling Hose, 150 psi Max WP

### Couplings

Contact fitting manufacturer for proper fitting recommendation and coupling procedure.

### Non-Stock/Sizes

Available up to 18" ID

### Order Codes

Black ChemiTuf®: 541-362 (1/4" tube gauge)  
 541-364\* (3/8" tube gauge)  
 541-360\* (1/2" tube gauge)  
 Black Pureten™: 541-372 (1/4" tube gauge)  
 541-350\* (3/8" tube gauge)  
 541-369\* (1/2" tube gauge)  
 Tan Pureten™: 541-380 (1/4" tube gauge)  
 541-366\* (3/8" tube gauge)  
 541-373\* (1/2" tube gauge)

## Diversipipe® 150

SAP #	ID	Nom. OD		Max. WP		Bend Radius		Vacuum HG		Weight		
(1/4)	in.	mm	in.	mm	psi	MPa	in.	mm	in.	mm	lb./ft.	kg/m
20046633	2	50.8	2.97	75.4	150	1.03	12	304.80	29	736.6	2.11	3.14
20221923	2½	63.5	3.44	87.4	150	1.03	15	381.00	29	736.6	2.65	3.95
20208953	3	76.2	3.94	100.1	150	1.03	18	457.20	29	736.6	3.05	4.54
20269765	4	101.6	5.00	127.0	150	1.03	24	609.60	29	736.6	4.10	6.11
20313031	4½	114.3	5.53	140.5	150	1.03	27	685.80	29	736.6	4.91	7.32
20543341	5	127.0	6.09	154.7	150	1.03	30	762.00	29	736.6	6.01	8.95
20015335	6	152.4	7.22	183.4	150	1.03	36	914.40	29	736.6	8.13	12.11
20556882	6⅝	168.3	7.84	199.1	150	1.03	40	1016.00	29	736.6	9.34	13.92
20686385	8	203.2	9.06	230.1	150	1.03	48	1219.20	29	736.6	11.51	17.15
20415228	8⅝	219.1	10.03	254.8	150	1.03	52	1320.80	29	736.6	14.35	21.38
20100181	10	254.0	11.38	289.1	150	1.03	60	1524.00	29	736.6	16.40	24.44
20290866	12	304.8	13.47	342.1	150	1.03	72	1828.80	29	736.6	19.83	29.55

\*Note: 3/8" and 1/2" tube gauge specs available on request. Contact Customer Service.

Air & Multipurpose  
 General Purpose  
 Heavy Duty  
 Push-on

Chemical Transfer

Cleaning Equipment

Food  
 Transfer  
 Washdown

Marine

**Material Handling**  
 Abrasives  
 Bulk Transfer  
 Cement & Concrete

Mining

**Petroleum**  
 Aircraft Fueling  
 Dispensing  
 Dock  
 Transfer

Spray

Steam

Vacuum

LPG Delivery

**Water**  
 Discharge  
 Suction & Discharge  
 Washdown

Welding

Coupling Systems

Equipment

Appendix

# Flexible Downspout



## Product Specifications

### Application

Flexible Downspout is an economical choice for gravity flow service. Install only in a vertical position.

### Construction Tube

1/8" Black ChemiTuf® synthetic rubber for abrasion resistance (static dissipating/static conductive)

### Cover

Black SBR synthetic rubber (wrapped impression)

### Reinforcement

Spiral-plied synthetic fabric

### Temperature Range

-25°F to 180°F (-32°C to 82°C)

### Packaging

Polywrapped

### Branding

Example: Continental ContiTech Flexible Downspout

### Couplings

Contact fitting manufacturer for proper fitting recommendation and coupling procedure.

### Non-Stock/Sizes

Available up to 18" ID

### Order Codes

541-015

## Flexible Downspout

SAP #	ID		Nom. OD		Max. WP		Weight	
	in.	mm	in.	mm	psi	MPa	lb./ft.	kg/m
20014797	4	101.6	4.41	111.9	50	0.34	1.28	1.89
20014798	4½	114.3	4.90	124.5	50	0.34	1.46	2.17
20014801	6	152.4	6.40	162.6	35	0.24	1.92	2.86
20014804	6⅝	168.3	7.02	178.3	35	0.24	2.11	3.14
20014808	8	203.2	8.40	213.4	25	0.17	2.54	3.78
20014809	8⅝	219.1	8.99	228.4	25	0.17	2.72	4.05
20014810	10	254.0	10.38	263.7	20	0.14	3.15	4.69
20025244	10¾	273.1	11.23	285.2	20	0.14	3.84	5.71
20014811	12	304.8	12.46	316.5	15	0.10	4.28	6.37
20014812	12¾	323.9	13.21	335.5	15	0.10	4.54	6.76
20014813	14	355.6	14.56	369.9	15	0.10	4.91	7.32
20014816	16	406.4	16.53	419.9	10	0.07	5.59	8.33

**Air & Multipurpose**  
General Purpose  
Heavy Duty  
Push-on

Chemical Transfer

Cleaning Equipment

**Food**  
Transfer  
Washdown

Marine

**Material Handling**  
Abrasives  
Bulk Transfer  
Cement & Concrete

Mining

**Petroleum**  
Aircraft Fueling  
Dispensing  
Dock  
Transfer

Spray

Steam

Vacuum

LPG Delivery

**Water**  
Discharge  
Suction & Discharge  
Washdown

Welding

Coupling Systems

Equipment

Appendix

# Plicord® Hydrovator™



## Product Specifications

### Application

A rugged yet lightweight hose designed exclusively for Hydrovac operations. Plicord® Hydrovator™ from Continental ContiTech combines the best in lightweight design and durability. ChemiTuf® tube handles the toughest Hydro Excavation jobs. The unique corrugated SBR cover provides superior flexibility in all applications. Hydrovator™ Hose rated for full vacuum. All sizes are rated for full vacuum.

### Construction Tube

Black natural rubber combined with a static dissipating ChemiTuf® liner.

### Cover

Static dissipating black SBR synthetic rubber with a heavy corrugated profile for high flexibility.

### Reinforcement

Double helix spiral steel wire with plies of synthetic fabric.

### Temperature Range

-25°F to 180°F (-32°C to 82°C)

### Packaging

Coiled or straight length.

### Branding

Example: Plicord® Hydrovator™ Vacuum Hose

### Couplings

Plain end, soft end or enlarged soft end.

### Non-Stock/Sizes

Built to length

### Order Codes

541-289

## Plicord® Hydrovator™

SAP #	ID		Nom. OD		Max. WP		Weight	
	in.	mm	in.	mm	psi	MPa	lb./ft.	kg/m
20435817	6	152.6	7.10	180.3	12	0.24	6.4	2.86
20435818	8	203.5	8.90	226.5	16	0.17	8.4	3.78
20435850	10	253.9	11.10	281.9	20	0.14	11.8	4.69

Air & Multipurpose

General Purpose

Heavy Duty

Push-on

Chemical Transfer

Cleaning Equipment

Food

Transfer

Washdown

Marine

Material Handling

Abrasives

Bulk Transfer

Cement & Concrete

Mining

Petroleum

Aircraft Fueling

Dispensing

Dock

Transfer

Spray

Steam

Vacuum

LPG Delivery

Water

Discharge

Suction & Discharge

Washdown

Welding

Coupling Systems

Equipment

Appendix

# Plicord® Dredge Sleeve



## Product Specifications

### Application

The Plicord® Dredge Sleeve is used as a flexible connection between pipe sections on the discharge line of hydraulic-type dredges.

### Construction Tube

3/8" ChemiTuf® abrasion-resistant rubber (static dissipating/ static conductive). Other gauges available upon request.

### Cover

Black SBR synthetic rubber (wrapped impression)

### Reinforcement

Multiple plies spirals synthetic and fabric

### Temperature Range

-25°F to 180°F (-32°C to 82°C)

### Packaging

Polywrapped

### Branding

Example: Continental ContiTech Plicord® Dredge Sleeve

### Couplings

Contact fitting manufacturer for proper fitting recommendation and coupling procedure.

### Order Codes

541-107

Available on request

541-290 1/2" ChemiTuf® tube 150 psi

541-177 1/2" Black Pureten™ 150 psi

541-081 3/4" ChemiTuf® tube 150 psi

541-316 3/4" Black Pureten™ 150 psi

## Plicord® Dredge Sleeve

SAP #	ChemiTuf® tube		Black Pureten		Nom. OD		Max. WP		Bend Radius		Weight			
	(1/2)	(3/4)	(1/2)	(3/4)	in.	mm	in.	mm	psi	MPa	in.	mm	lb./ft.	kg/m
20014987	20276210			20286716	6 <sup>5</sup> / <sub>8</sub>	168.3	8.22	208.8	75	0.52	60	1524	9.77	14.54
20014993	20015204		20222676	20217385	8 <sup>5</sup> / <sub>8</sub>	219.1	10.31	261.9	75	0.52	80	2032	13.59	20.22
20014999	20015209	20156102	20147951	20143628	10 <sup>3</sup> / <sub>4</sub>	273.1	12.50	317.5	75	0.52	100	2540	16.72	24.88
20169040	20015213	20149436	20148851	20139966	12 <sup>3</sup> / <sub>4</sub>	323.9	14.53	369.1	75	0.52	120	3048	20.04	29.82
20229635	20015217	20157129		20139943	14	355.6	15.89	403.6	75	0.52	140	3556	22.65	33.71
20099933	20015221	20659873	20346340	20276774	16	406.4	17.84	453.1	75	0.52	160	4064	24.91	37.07
20115098	20032603	20264965		20333400	18	457.2	19.94	506.5	75	0.52	180	4572	27.80	41.37

**Air & Multipurpose**  
General Purpose  
Heavy Duty  
Push-on

Chemical Transfer

Cleaning Equipment

**Food**  
Transfer  
Washdown

Marine

**Material Handling**  
Abrasives  
Bulk Transfer  
Cement & Concrete

Mining

**Petroleum**  
Aircraft Fueling  
Dispensing  
Dock  
Transfer

Spray

Steam

Vacuum

LPG Delivery

**Water**  
Discharge  
Suction & Discharge  
Washdown

Welding

Coupling Systems

Equipment

Appendix

# Plicord® RVC



## Product Specifications

### Application

For use on reverse drilling rigs.

### Construction Tube

Black ChemiTuf® synthetic rubber: 1/4" Gauge-2"-4" I.D.; 1/2" Gauge-6"; 3/8" Gauge-8"

### Cover

Blue SBR synthetic rubber with orange spiral transfer brand (wrapped impression)

### Reinforcement

Spiral-plied synthetic fabric: 2" & 3" ID-6 plies; 4" & 6" ID-8 plies; 8" ID-10 plies

### Temperature Range

-20°F to 180°F (-29°C to 82°C)

### Packaging

2"-4", 100' length, coiled polywrapped; 6"-8", 50' length, shipped straight polywrapped over 6", custom lengths up to 100'

### Branding (Spiral)

Example: Continental ContiTech Reverse Circulation 600 psi Max W.P. Made in Canada

### Couplings

Contact fitting manufacturer for proper fitting recommendation and coupling procedure.

### Non-Stock/Sizes

Custom lengths available.

### Order Codes

549-341 (2"-4")  
541-341 (6" and 8")

## Plicord® RVC

SAP #	ID	Nom. OD		Max. WP		Weight		
		in.	mm	psi	MPa	lb./ft.	kg/m	
20019560	2	50.8	3.11	79.0	600	4.14	2.37	3.53
20019565	3	76.2	4.17	105.9	600	4.14	3.39	5.04
20019567	4	101.6	5.39	136.9	600	4.14	5.15	7.66
20015297	6	152.4	7.91	200.9	500	3.45	10.66	15.86

Air & Multipurpose

General Purpose

Heavy Duty

Push-on

Chemical Transfer

Cleaning Equipment

Food

Transfer

Washdown

Marine

Material Handling

Abrasives

Bulk Transfer

Cement & Concrete

Mining

Petroleum

Aircraft Fueling

Dispensing

Dock

Transfer

Spray

Steam

Vacuum

LPG Delivery

Water

Discharge

Suction & Discharge

Washdown

Welding

Coupling Systems

Equipment

Appendix

# Plicord® Sand Suction



## Product Specifications

### Application

Plicord® Sand Suction hose is for use on the suction end of hydraulic dredges. It provides a flexible connection between dredging lines and pumps.

### Construction Tube

3/8" Black ChemiTuf®w synthetic rubber for abrasion resistance (static dissipating/static conductive). Also available in 1/2" or 3/4" tube gauge.

### Cover

Black SBR synthetic rubber (wrapped impression)

### Reinforcement

Spiral-plied synthetic fabric with wire helix

### Temperature Range

-25°F to 180°F (-32°C to 82°C)

### Packaging

Custom lengths polywrapped

### Branding

Example: Continental ContiTech Style M Sand Suction

### Couplings

Contact fitting manufacturer for proper fitting recommendation and coupling procedure.

### Non-Stock/Sizes

Custom lengths available.

### Order Codes

541-267 (3/8" tube)

541-268 (3/4" tube)

541-265 (1/2" tube)

## Plicord® Sand Suction

SAP #	Black		ID	Nom. OD		Bend Radius		Vacuum HG		Weight		
	(3/8" tube)	(3/4" tube)		(1/2" tube)	in.	mm	in.	mm	in.	mm	lb./ft.	kg/m
20371749	20015144		4	101.6	5.31	134.9	40	1016	30	762	5.71	8.50
20029485	20015145		5	127.0	6.98	177.3	46	1168	30	762	9.47	14.09
20207629		20113822	6	152.4	7.54	191.5	52	1321	30	762	11.35	16.89
20176213			6½	168.3	8.20	208.3	55	1397	30	762	13.96	20.77
20219625	20015150		8	203.2	9.63	244.6	62	1575	30	762	16.93	25.19
20291577		20150200	8½	219.1	10.25	260.4	68	1727	30	762	17.85	26.56
20418594	20015155		10	254.0	11.81	300.0	76	1930	30	762	23.94	35.63
20015186		20015160	10¾	273.1	12.63	320.8	82	2083	30	762	25.68	38.22
20221702	20015164		12	304.8	13.91	353.3	91	2311	30	762	28.95	43.08
20015191	20174216	20015171	12¾	323.9	14.59	370.6	94	2388	30	762	29.98	44.61

**Air & Multipurpose**  
General Purpose  
Heavy Duty  
Push-on

Chemical Transfer

Cleaning Equipment

**Food**  
Transfer  
Washdown

Marine

**Material Handling**  
Abrasives  
Bulk Transfer  
Cement & Concrete

Mining

**Petroleum**  
Aircraft Fueling  
Dispensing  
Dock  
Transfer

Spray

Steam

Vacuum

LPG Delivery

**Water**  
Discharge  
Suction & Discharge  
Washdown

Welding

Coupling Systems

Equipment

Appendix

# Spiraflex® Air Seeder Hose



## Product Specifications

### Application

For dry conveying of seeds and other materials where abrasion is present and service conditions are moderate. Excellent for low-pressure blowing applications.

### Construction Tube

Clear thermoplastic urethane

### Cover

Clear flexible vinyl

### Reinforcement

White rigid vinyl helix

### Temperature Range

0°F to 158°F (-18°C to 70°C)

### Packaging

Coil wrapped with cardboard and stretch film

### Branding

Date code only

### Couplings

Contact fitting manufacturer for proper fitting recommendation and coupling procedure.

### Order Codes

586-450

## Spiraflex® Air Seeder

SAP #	ID	Nom. OD		Max. WP		Bend Radius		Vacuum HG		Weight			
		in.	mm	in.	mm	psi	MPa	in.	mm	in.	mm	lb./ft.	kg/m
20013448	1	Clear	25.4	1.25	32.0	60	.41	3	76.19	29	737	.195	0.29
20013450	1½		38.1	1.82	46.2	50	.34	4	101.60	29	737	.320	0.48
20013451	2		50.8	2.37	60.4	40	.27	5	127.00	29	737	.420	0.63
20013452	2½		63.5	2.87	72.9	40	.27	7	177.79	29	737	.650	0.99
20013453	3		76.2	3.42	86.8	35	.24	8	203.20	29	737	.890	1.33
20013454	4		101.6	4.50	114.4	27	.18	11	279.4	29	737	.997	1.48

**Air & Multipurpose**

- General Purpose
- Heavy Duty
- Push-on

Chemical Transfer

Cleaning Equipment

**Food**

- Transfer
- Washdown

Marine

**Material Handling**

- Abrasives
- Bulk Transfer
- Cement & Concrete

Mining

**Petroleum**

- Aircraft Fueling
- Dispensing
- Dock Transfer

Spray

Steam

Vacuum

LPG Delivery

**Water**

- Discharge
- Suction & Discharge
- Washdown

Welding

Coupling Systems

Equipment

Appendix



# Spirathane™ HD



## Product Specifications

### Application

For dry pneumatic conveying of solids where heavy duty abrasive conditions are present. Sizes 1½"-5" rated to full vacuum.

### Construction Tube

Polyurethane RMA Class B (Medium Oil Resistance) with improved abrasion resistance

### Cover

High-density, low-temperature blue Pliovic® compound

### Reinforcement

High-density, rigid Pliovic® PVC helix

### Temperature Range

0°F to 158°F (-18°C to 70°C)

### Packaging

1½"-6" - 100' lengths, coiled and polywrapped  
8"-10" - 0' lengths, polytube with corrugated protection

### Branding

Not branded

### Couplings

Contact fitting manufacturer for proper fitting recommendation and coupling procedure.

### Order Codes

586-407

## Spirathane™ HD

SAP #	ID		Nom. OD		Max. WP		Bend Radius		Vacuum HG		Weight	
	in.	mm	in.	mm	psi	MPa	in.	mm	in.	mm	lb./ft.	kg/m
20013134	1½	38.1	1.86	47.2	50	0.34	4	99	29	737	0.34	0.51
20013137	2	50.8	2.47	62.7	50	0.34	6	140	29	737	0.63	0.94
20013138	2½	63.5	3.12	79.3	50	0.34	7	178	29	737	0.95	1.41
20013141	3	76.2	3.64	92.5	40	0.28	8	203	29	737	1.37	2.04
20013144	4	101.6	4.77	121.2	35	0.24	14	356	29	737	1.98	2.95
20013146	5	127.0	5.83	148.1	30	0.21	20	508	29	737	2.41	3.59
20013149	6	152.4	6.84	173.7	23	0.16	25	635	25	635	3.08	4.58
20013150	8	203.2	8.75	222.3	20	0.14	48	1219	25	635	4.53	6.74
20013151	10	254.0	10.96	278.4	20	0.14	75	1905	25	635	6.36	9.46

**Air & Multipurpose**  
General Purpose  
Heavy Duty  
Push-on

Chemical Transfer

Cleaning Equipment

**Food**  
Transfer  
Washdown

Marine

**Material Handling**  
Abrasives  
Bulk Transfer  
Cement & Concrete

Mining

**Petroleum**  
Aircraft Fueling  
Dispensing  
Dock  
Transfer

Spray

Steam

Vacuum

LPG Delivery

**Water**  
Discharge  
Suction & Discharge  
Washdown

Welding

Coupling Systems

Equipment

Appendix

# Spirathane™ PT

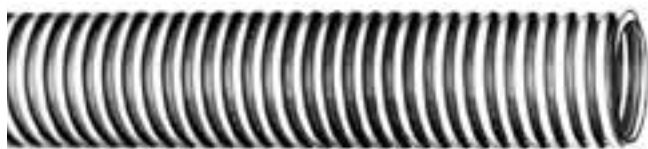

## Product Specifications

### Application

For the transfer of a variety of dry, bulk and abrasive materials. It is used in applications where static electrical buildup is common. For powders, plastic pellets and granular materials.

### Construction Tube

Polyurethane conforms to FDA standards.

### Cover

High molecular weight, clear PVC, corrugated for flexibility.

### Reinforcement

High-density, rigid Pliovic® PVC helix with static wire placed between tube and cover.

### Temperature Range

0°F to 158°F (-18°C to 70°C)

### Packaging

100' lengths, coiled and polywrapped

### Branding

Not branded

### Couplings

Contact fitting manufacturer for proper fitting recommendation and coupling procedure.

### Order Codes

586-489

## Spirathane™ PT

SAP #	ID		Nom. OD		Max. WP		Bend Radius		Vacuum HG		Weight	
	Clear	in.	mm	in.	mm	psi	MPa	in.	mm	in.	mm	lb./ft.
20013682	1½	38.1	1.82	46.2	45	0.31	4	102	29	737	0.31	0.46
20013683	1¾	44.5	2.15	54.6	45	0.31	5	127	29	737	0.38	0.57
20013684	2	50.8	2.38	60.5	30	0.21	6	152	29	737	0.52	0.77
20013685	2¼	57.2	2.77	70.4	35	0.24	7	165	29	737	0.63	0.94
20013686	2½	63.5	3.03	77.0	30	0.21	7	178	29	737	0.69	1.03
20013687	3	76.2	3.63	92.2	30	0.21	8	203	29	737	1.15	1.71
20013688	4	101.6	4.76	120.9	27	0.19	14	356	29	737	1.63	2.43
20046048	5	127.0	5.83	148.1	27	0.19	20	508	29	737	2.13	3.17

**Air & Multipurpose**

- General Purpose
- Heavy Duty
- Push-on

Chemical Transfer

Cleaning Equipment

**Food**

- Transfer
- Washdown

Marine

**Material Handling**

- Abrasives
- Bulk Transfer
- Cement & Concrete

Mining

**Petroleum**

- Aircraft Fueling
- Dispensing
- Dock Transfer

Spray

Steam

Vacuum

LPG Delivery

**Water**

- Discharge
- Suction & Discharge
- Washdown

Welding

Coupling Systems

Equipment

Appendix

# Spirathane™ LD

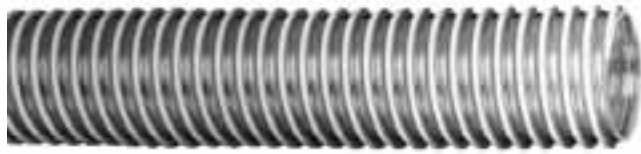

## Product Specifications

### Application

For dry pneumatic conveying of solid fines where abrasion is present and service conditions are moderate. Excellent for low-pressure blowing applications.

### Construction Tube

Clear Polyurethane, RMA Class B (Medium Oil Resistance)

### Reinforcement

High-density rigid white Pliovic® helix

### Temperature Range

0°F to 158°F (-18°C to 70°C)

### Packaging

1½'-6" - 100' lengths, coiled and polywrapped

8'-10" - 20' lengths, polywrapped with corrugated protection

### Branding

Not branded

### Couplings

Contact fitting manufacturer for proper fitting recommendation and coupling procedure.

### Order Codes

586-406

## Spirathane™ LD

SAP #	ID	Nom. OD		Max. WP		Bend Radius		Vacuum HG		Weight		
Clear	in.	mm	in.	mm	psi	MPa	in.	mm	in.	mm	lb./ft.	kg/m
20013121	1½	38.1	1.84	46.7	30	0.21	2	51	22	559	0.25	0.37
20013123	2	50.8	2.35	59.7	25	0.17	3	71	21	533	0.34	0.51
20013124	2½	63.5	2.89	73.4	20	0.14	4	89	19	483	0.44	0.65
20013125	3	76.2	3.45	87.6	20	0.14	4	102	18	457	0.60	0.89
20013127	4	101.6	4.53	115.1	15	0.10	7	178	13	330	0.88	1.31
20013128	5	127.0	5.56	141.2	10	0.07	8	203	10	254	1.09	1.62
20013130	6	152.4	6.57	166.9	10	0.07	12	305	7	178	1.53	2.28
20013131	8	203.2	8.59	218.2	6	0.04	23	584	5	127	1.73	2.57
20013133	10	254.0	10.75	273.1	5	0.03	30	762	4	102	2.75	4.09

**Air & Multipurpose**  
General Purpose  
Heavy Duty  
Push-on

Chemical Transfer

Cleaning Equipment

**Food**  
Transfer  
Washdown

Marine

**Material Handling**  
Abrasives  
Bulk Transfer  
Cement & Concrete

Mining

**Petroleum**  
Aircraft Fueling  
Dispensing  
Dock  
Transfer

Spray

Steam

Vacuum

LPG Delivery

**Water**  
Discharge  
Suction & Discharge  
Washdown

Welding

Coupling Systems

Equipment

Appendix

# Bulk Transfer



**Air & Multipurpose**

- General Purpose
- Heavy Duty
- Push-on

Chemical Transfer

Cleaning Equipment

**Food**

- Transfer
- Washdown

Marine

**Material Handling**

- Abrasives
- Bulk Transfer
- Cement & Concrete

Mining

**Petroleum**

- Aircraft Fueling
- Dispensing
- Dock Transfer

Spray

Steam

Vacuum

LPG Delivery

**Water**

- Discharge
- Suction & Discharge
- Washdown

Welding

Coupling Systems

Equipment

Appendix

	Page	Food Grade	Static Dissipating/ Static Conductive Tube	Temp. Range	Suction	Discharge Only
Black Softwall	126		Yes	-25°F to 180°F (-32°C to 82°C)		Yes
Flextra Dry Material	125		Yes	-40°F to 180°F (-40°C to 82°C)	Yes	
Plicord Torridair Hot Air Blower	127			-40°F to 400°F (-40°C to 205°C)	Yes	
Pyroflex II Hot Air	128			-20°F to 325°F (-29°C to 163°C)	Yes	
Pyroflex III Hot Air	129	Yes		-20°F to 325°F (-29°C to 163°C)	Yes	
Mulchblower	130			0°F to 158°F (-18°C to 70°C)		
Tan Flextra	132	Yes		-40°F to 180°F (-40°C to 82°C)	Yes	
Tan Flexwing	131	Yes		-40°F to 180°F (-40°C to 82°C)	Yes	
Tan Softwall	133	Yes		-40°F to 180°F (-40°C to 82°C)		Yes

# Flextra® Dry Material



## Product Specifications

### Application

A static dissipating/static conductive hose for tank truck and in-plant service. Used to convey non-oily abrasive materials such as sand, limestone and plastic pellets. Recommended where static buildup can be a problem.

### Construction Tube

3/16" Gauge Black ChemiTuf® synthetic rubber (static dissipating/static conductive)

### Cover

Black SBR synthetic rubber (corrugated) with yellow spiral band (wrapped impression)

### Reinforcement

Spiral-plied synthetic fabric with wire helix

### Temperature Range

-40°F to 180°F (-40°C to 82°C)

### Packaging

100' lengths, coiled and polywrapped

### Branding (Spiral)

Example: Continental ContiTech Flextra® Dry Material 75 psi WP

### Couplings

Contact fitting manufacturer for proper fitting recommendation and coupling procedure.

### Order Codes

549-126

## Flextra® Dry Material

SAP #	ID		Nom. OD		Max. WP		Bend Radius		Vacuum HG		Weight	
	in.	mm	in.	mm	psi	MPa	in.	mm	in.	mm	lb./ft.	kg/m
20421726	1½	38.1	2.11	53.6	75	0.52	4	89	29	737	1.03	1.53
20019229	2	50.8	2.63	66.8	75	0.52	4	102	29	737	1.29	1.92
20019230	3	76.2	3.69	93.7	75	0.52	6	152	29	737	2.15	3.20
20019233	4	101.6	4.75	120.7	75	0.52	9	229	29	737	3.09	4.60
20019234	5	127.0	5.78	146.9	75	0.52	20	500	29	737	4.16	6.20
20019235	6	152.4	6.81	173.1	75	0.52	24	600	29	737	5.47	8.15

**Air & Multipurpose**  
General Purpose  
Heavy Duty  
Push-on

Chemical Transfer

Cleaning Equipment

**Food**  
Transfer  
Washdown

Marine

**Material Handling**  
Abrasives  
Bulk Transfer  
Cement & Concrete

Mining

**Petroleum**  
Aircraft Fueling  
Dispensing  
Dock  
Transfer

Spray

Steam

Vacuum

LPG Delivery

**Water**  
Discharge  
Suction & Discharge  
Washdown

Welding

Coupling Systems

Equipment

Appendix

# Black Softwall



## Product Specifications

### Application

For the discharge of dry bulk cement from tank truck and in-plant service.

### Construction Tube

1/8" (static dissipating/static conductive) Black ChemiTuf® synthetic rubber. Available in 1/8", 3/16", and 1/4" tube gauges

### Cover

Black SBR synthetic rubber with white spiral stripe (wrapped impression)

### Reinforcement

Spiral-plied synthetic fabric

### Temperature Range

-25°F to 180°F (-32°C to 82°C)

### Packaging

100' lengths, coiled and polywrapped

### Branding (Spiral)

Example: Continental ContiTech Black Softwall

### Black Softwall

Order Codes: 549-152-0

SAP #		Dia.	ID	OD	Weight
(1/8")	Survivor Compound	PO	mm	mm	#/ft.
20019306		3	76.1	86.3	1.05
20019309	20665783	4	102.1	112.3	1.38
20046192		4½	114.6	125.4	1.64
20019315	20677559	5	127.4	138.2	1.82
20019319		6	152.7	163.9	2.25

### Couplings

Contact fitting manufacturer for proper fitting recommendation and coupling procedure. Use Continental ContiTech Insta-Lock™ Cam & Groove Fittings with this product. See the Coupling Systems information pages at the back of the catalog.

### Order Codes

549-152 (1/8" tube gauge 50 psi)  
 549-149 (3/16" tube gauge 75 psi)  
 549-148 (1/4" tube gauge 50 psi)

### Black Softwall

Order Codes: 549-149-0

SAP #		Dia.	ID	OD	Weight
(3/16")	Survivor Compound	PO	mm	mm	#/ft.
20019281	20673663	4	102.1	116.2	1.92
20029627		4½	114.6	129.0	2.21
20109496		5	127.4	141.8	2.44
20468267		5½	140.1	154.5	2.67
20446687		6	152.7	167.7	3.01

### Black Softwall

Order Codes: 549-148-0

SAP #		Dia.	ID	OD	Weight
(1/4")	Survivor Compound	PO	mm	mm	#/ft.
20019277	20639327	4	102.1	118.7	2.29
20311113		4½	114.6	131.8	2.65
20019279		5	127.4	145.0	3
20019280		6	152.7	170.3	3.56

Air & Multipurpose

General Purpose

Heavy Duty

Push-on

Chemical Transfer

Cleaning Equipment

Food

Transfer

Washdown

Marine

Material Handling

Abrasives

Bulk Transfer

Cement & Concrete

Mining

Petroleum

Aircraft Fueling

Dispensing

Dock

Transfer

Spray

Steam

Vacuum

LPG Delivery

Water

Discharge

Suction & Discharge

Washdown

Welding

Coupling Systems

Equipment

Appendix

# Plicord® Torridair™ Hot Air Blower



## Product Specifications

### Application

Designed to transfer hot, non-oily air, up to 400°F (204°C), from manifold blowers or in-plant compressors to holding tanks used in the transfer of dry bulk materials.

### Construction Tube

Black, STF (Super Thermo-Flo) EPDM synthetic rubber

### Cover

Black, weather-resistant, STF (Super Thermo-Flo) EPDM synthetic rubber (wrapped impression)

### Reinforcement

Spiral-plied synthetic fabric with double wire helix

### Temperature Range

-40°F to 400°F (-40°C to 204°C)

### Packaging

100' lengths, coiled and polywrapped

### Branding (Spiral)

Example: Continental ContiTech Torridair™ Blower Hose 400°F (204°C)

### Couplings

Contact fitting manufacturer for proper fitting recommendation and coupling procedure. Use Continental ContiTech Insta-Lock™ Cam & Groove Fittings with this product. See the Coupling Systems information pages at the back of the catalog.

### Order Codes

549-856

## Plicord® Torridair™

SAP #	ID		Nom. OD		Max. WP		Bend Radius		Vacuum HG		Weight	
	in.	mm	in.	mm	psi	MPa	in.	mm	in.	mm	lb./ft.	kg/m
20020255	2	50.8	2.51	63.8	100	0.52	5	127	29	737	1.06	1.58
20020257	2½	63.5	3.00	76.2	100	0.52	6	152	29	737	1.35	2.01
20020260	3	76.2	3.53	89.7	100	0.52	7	178	29	737	1.84	2.74
20020261	4	101.6	4.60	116.8	100	0.69	16	400	29	737	2.47	3.68
20130428	6	152.4	6.70	170.0	100	0.69	30	750	29	737	4.46	6.65

**Air & Multipurpose**  
General Purpose  
Heavy Duty  
Push-on

Chemical Transfer

Cleaning Equipment

**Food**  
Transfer  
Washdown

Marine

**Material Handling**  
Abrasives  
Bulk Transfer  
Cement & Concrete

Mining

**Petroleum**  
Aircraft Fueling  
Dispensing  
Dock  
Transfer

Spray

Steam

Vacuum

LPG Delivery

**Water**  
Discharge  
Suction & Discharge  
Washdown

Welding

Coupling Systems

Equipment

Appendix

# Pyroflex® II Hot Air



## Product Specifications

### Application

For conveying hot air from compressors to tanks on bulk dry material carriers.

### Construction Tube

Black heat-resistant EPDM synthetic rubber

### Cover

Heat-resistant black EPDM synthetic rubber with orange spiral stripe (wrapped impression)

### Reinforcement

Spiral-plied synthetic fabric with wire helix

### Temperature Range

-20°F to 325°F (-29°C to 163°C)

### Packaging

100' lengths, coiled and polywrapped

### Branding (Spiral)

Example: Continental ContiTech Pyroflex® II Hot Air

### Couplings

Contact fitting manufacturer for proper fitting recommendation and coupling procedure. Use Continental ContiTech Insta-Lock™ Cam & Groove Fittings with this product. See the Coupling Systems information pages at the back of the catalog.

### Order Codes

549-394

## Pyroflex® II Hot Air

SAP #	ID		Nom. OD		Max. WP		Bend Radius		Vacuum HG		Weight	
	in.	mm	in.	mm	psi	MPa	in.	mm	in.	mm	lb./ft.	kg/m
20019669	2	50.8	2.55	64.8	100	0.34	5	127	29	737	1.22	1.82
20019671	3	76.2	3.55	90.2	100	0.34	7	178	29	737	1.93	2.87
20019674	4	101.6	4.61	117.1	100	0.34	10	254	29	737	2.65	3.94
20019675	6	152.4	6.74	171.1	100	0.35	30	750	29	737	4.80	7.15

**Air & Multipurpose**

- General Purpose
- Heavy Duty
- Push-on

Chemical Transfer

Cleaning Equipment

**Food**

- Transfer
- Washdown

Marine

**Material Handling**

- Abrasives
- Bulk Transfer
- Cement & Concrete

Mining

**Petroleum**

- Aircraft Fueling
- Dispensing
- Dock Transfer

Spray

Steam

Vacuum

LPG Delivery

**Water**

- Discharge
- Suction & Discharge
- Washdown

Welding

Coupling Systems

Equipment

Appendix



# Pyroflex® III Hot Air



## Product Specifications

### Application

For conveying hot air with FDA compliant tube that can be used in unloading edible materials.

### Construction Tube

White EPDM - FDA compliant

### Cover

Red Standard EPDM

### Reinforcement

Spiral-plied synthetic fabric with wire helix

### Temperature Range

-20°F to 325°F (-28.8°C to 162.8°C)

### Packaging

100' lengths, coiled and polywrapped

### Branding (Spiral)

Example: Continental ContiTech Pyroflex® III Hot Air Blower - FDA Compliant Made in Canada

### Couplings

Use Continental ContiTech Insta-Lock Cam & Groove Fittings with this product. Other fitting types contact fitting company.

### Non-Stock/Sizes

100 ft. for stock and 400 ft. for MTO

### Order Codes

549-952

## Pyroflex® III Hot Air

SAP #	Nom. ID		Nom. OD		Max. WP		Bend Radius		Vacuum HG		Weight	
	in.	mm	in.	mm	psi	MPa	in.	mm	in.	mm	lb./ft.	kg/m
20762191	1½	3.81	2.04	51.7	100	0.34	4	101.6	29	737	0.94	1.4
20762192	2	50.8	2.55	64.8	100	0.34	5	127	29	737	1.24	1.85
20762193	2½	63.5	3.06	77.8	100	0.34	6	152.4	29	737	1.67	2.49
20762194	3	76.2	3.56	90.5	100	0.34	7	178	29	737	1.97	2.94
20762195	4	101.6	4.61	117.1	100	0.34	10	254	29	737	2.72	4.05

**Air & Multipurpose**  
General Purpose  
Heavy Duty  
Push-on

Chemical Transfer

Cleaning Equipment

**Food**  
Transfer  
Washdown

Marine

**Material Handling**  
Abrasives  
Bulk Transfer  
Cement & Concrete

Mining

**Petroleum**  
Aircraft Fueling  
Dispensing  
Dock  
Transfer

Spray

Steam

Vacuum

LPG Delivery

**Water**  
Discharge  
Suction & Discharge  
Washdown

Welding

Coupling Systems

Equipment

Appendix

# Mulch Blower



## Product Specifications

### Application

A high-strength, mulch-blowing hose that's flexible and durable. It provides visible, unrestricted material applications in a buildup and hose balance.

Sprays mulch, woodchips and other materials for landscaping applications in a wide range of environments.

### Construction Tube

Clear High Molecular Weight PVC

### Reinforcement

Yellow Rigid PVC Helix

### Temperature Range

0°F to 158°F (-18°C to 70°C)

### Packaging

100' coils covered with stretch film and cardboard

### Branding

Not branded

### Stock Sizes

4" and 5"

### Order Codes

586-553

## SpiraFlex® Mulch Blower

SAP #	ID		Nom. OD		Max. WP Bend Radius			Vacuum HG		Weight		
	Clear	in.	mm	in.	mm	psi	in.	mm	in.	mm	lb./ft.	kg/m
20013644	4		101.6	5.02	127.4	15	6	152.4	29	737	1.05	0.15
20024982	5		127	5.61	142.4	15	9	228.6	29	737	1.25	0.17

**Air & Multipurpose**

General Purpose

Heavy Duty

Push-on

Chemical Transfer

Cleaning Equipment

**Food**

Transfer

Washdown

Marine

**Material Handling**

Abrasives

Bulk Transfer

Cement & Concrete

Mining

**Petroleum**

Aircraft Fueling

Dispensing

Dock

Transfer

Spray

Steam

Vacuum

LPG Delivery

**Water**

Discharge

Suction & Discharge

Washdown

Welding

Coupling Systems

Equipment

Appendix

# Tan Flexwing®



## Product Specifications

### Application

Tan Flexwing® is for acids, alcohol bases and salt solutions.

### Construction Tube

Tan Pureten™ gum rubber (non oil-resistant) (FDA/USDA compliant)

### Cover

Tan SBR synthetic rubber (non oil-resistant) with blue spiral stripe (wrapped impression)

### Reinforcement

Spiral-plied synthetic fabric with wire helix

### Temperature Range

-40°F to 180°F (-40°C to 82°C)

### Packaging

100' lengths, coiled and polywrapped

### Branding (Spiral)

Example: Continental ContiTech Tan Flexwing® with Pureten™ 150 psi WP

### Couplings

Contact fitting manufacturer for proper fitting recommendation and coupling procedure.

### Order Codes

546-068

### Tan Flexwing®

SAP #	ID	Nom. OD		Max. WP		Bend Radius		Vacuum HG		Weight		
		in.	mm	in.	mm	in.	mm	in.	mm	lb./ft.	kg/m	
20018549	1	25.4	1.61	40.9	150	1.03	3.5	89	29	737	0.75	1.12
20050636	1½	38.1	2.14	54.4	150	1.03	4.0	102	29	737	1.08	1.61
20018551	2	50.8	2.68	68.1	150	1.03	5.0	127	29	737	1.44	2.14
20018555	3	76.2	3.75	95.3	150	1.03	7.0	178	29	737	2.32	3.45
20018557	4	101.6	4.83	122.7	150	1.03	10.0	254	29	737	3.39	5.04
20221775	6	152.4	6.96	176.8	150	1.03	30.0	762	29	737	6.04	8.99

**Air & Multipurpose**  
General Purpose  
Heavy Duty  
Push-on

Chemical Transfer

Cleaning Equipment

**Food**  
Transfer  
Washdown

Marine

**Material Handling**  
Abrasives  
Bulk Transfer  
Cement & Concrete

Mining

**Petroleum**  
Aircraft Fueling  
Dispensing  
Dock  
Transfer

Spray

Steam

Vacuum

LPG Delivery

**Water**  
Discharge  
Suction & Discharge  
Washdown

Welding

Coupling Systems

Equipment

Appendix

# Tan Flextra®



**Air & Multipurpose**  
 General Purpose  
 Heavy Duty  
 Push-on

Chemical Transfer

Cleaning Equipment

**Food**  
 Transfer  
 Washdown

Marine

**Material Handling**  
 Abrasives  
 Bulk Transfer  
 Cement & Concrete

Mining

**Petroleum**  
 Aircraft Fueling  
 Dispensing  
 Dock  
 Transfer

Spray

Steam

Vacuum

LPG Delivery

**Water**  
 Discharge  
 Suction & Discharge  
 Washdown

Welding

Coupling Systems

Equipment

Appendix

## Product Specifications

### Application

For tank truck and in-plant service. Used to convey non-oily abrasive materials such as sand, limestone, plastic pellets and dry abrasive food products.

### Construction Tube

Pureten™ gum rubber (FDA/USDA compliant)

### Cover

Tan SBR gum rubber (corrugated) with yellow spiral stripe (wrapped impression)

### Reinforcement

Spiral-plied synthetic fabric with wire helix

### Temperature Range

-40°F to 180°F (-40°C to 82°C)

### Packaging

1½"-4" - 100' lengths, coiled and polywrapped  
 5"-6" - 50' lengths, coiled and polywrapped

### Branding (Spiral)

Example: Continental ContiTech Tan Flextra® with Pureten™ 75 psi WP

### Couplings

Contact fitting manufacturer for proper fitting recommendation and coupling procedure.

### Order Codes

549-116

## Tan Flextra®

SAP #	ID	Nom. OD		Max. WP		Bend Radius		Vacuum HG		Weight		
		in.	mm	in.	mm	in.	mm	in.	mm	lb./ft.	kg/m	
20019210	1½	38.0	2.09	53.1	75	0.52	4	102	29	737	0.99	1.47
20019212	2	50.8	2.60	66.0	75	0.52	4	102	29	737	1.21	1.80
20019216	3	76.2	3.63	92.2	75	0.52	6	152	29	737	1.94	2.89
20019217	4	101.6	4.69	119.1	75	0.52	9	229	29	737	2.74	4.08
20132671	5	127.0	5.78	146.8	75	0.52	12	305	29	737	4.26	6.34
20019224	6	152.4	6.78	172.2	75	0.52	15	381	29	737	4.92	7.32

# Tan Softwall



## Product Specifications

### Application

A fabric-reinforced hose for the discharge of non-oily abrasive materials such as sand, limestone, gravel, plastic pellets and dry food products. For use where static electrical buildup is not a problem.

### Construction Tube

Tan Pureten™ gum rubber (FDA/USDA compliant)

### Cover

Tan SBR synthetic rubber (wrapped impression)

### Reinforcement

Spiral-plied synthetic fabric with static wire

### Temperature Range

-40°F to 180°F (-40°C to 82°C)

### Packaging

2"-4" - 100' lengths, coiled and polywrapped  
5"-6" - 50' lengths, coiled and polywrapped

### Branding (Spiral)

Example: Continental ContiTech Tan Softwall with Pureten™ 75 psi WP

### Couplings

Contact fitting manufacturer for proper fitting recommendation and coupling procedure.

### Order Codes

549-040

## Tan Softwall

SAP #	ID		Nom. OD		Max. WP		Weight	
	in.	mm	in.	mm	psi	MPa	lb./ft.	kg/m
20045907	2	50.8	2.68	68.1	75	0.52	1.22	1.82
20019116	3	76.2	3.69	93.7	75	0.52	1.80	2.68
20019118	4	101.6	4.78	121.4	75	0.52	2.61	3.88
20019119	5	127.0	5.77	146.6	75	0.52	3.19	4.75
20019120	6	152.4	6.77	172.0	75	0.52	3.78	5.63

**Air & Multipurpose**  
General Purpose  
Heavy Duty  
Push-on

Chemical Transfer

Cleaning Equipment

**Food**  
Transfer  
Washdown

Marine

**Material Handling**  
Abrasives  
Bulk Transfer  
Cement & Concrete

Mining

**Petroleum**  
Aircraft Fueling  
Dispensing  
Dock  
Transfer

Spray

Steam

Vacuum

LPG Delivery

**Water**  
Discharge  
Suction & Discharge  
Washdown

Welding

Coupling Systems

Equipment

Appendix

# Cement & Concrete



**Air & Multipurpose**

- General Purpose
- Heavy Duty
- Push-on

Chemical Transfer

Cleaning Equipment

**Food**

- Transfer
- Washdown

Marine

**Material Handling**

- Abrasives
- Bulk Transfer
- Cement & Concrete

Mining

**Petroleum**

- Aircraft Fueling
- Dispensing
- Dock
- Transfer

Spray

Steam

Vacuum

LPG Delivery

**Water**

- Discharge
- Suction & Discharge
- Washdown

Welding

Coupling Systems

Equipment

Appendix

	Page	Textile	Wire
Allcrete Textile (plaster, grout & concrete)	136	Yes	
Allcrete Wire	137		Yes
PGC Placement Textile	138	Yes	
Plicord Auger Arc Piling	135	Yes	
Plicord Gunite (tan)	139	Yes	

# Plicord® Auger Arc Piling



## Product Specifications

### Application

For use in handling a multitude of materials being pumped to concrete forms and structures.

### Construction Tube

Black ChemiTuf®

### Cover

Black SBR with gray abrasion-resistant spiral strip

### Reinforcement

6 fabric plies with boot straps

### Temperature Range

-35°F to 180°F (-37°C to 82°C)

### Packaging

50' lengths, coiled and poly-wrapped

### Branding (Spiral)

Example: Continental ContiTech Auger Arc Piling

### Couplings

Contact fitting manufacturer for proper fitting recommendation and coupling procedure.

### Order Codes

549-815

## Plicord® Auger Arc Piling

SAP #	ID		Nom. OD		Max. WP		Weight	
	in.	mm	in.	mm	psi	MPa	lb./ft.	kg/m
20046556	2	50.8	3.03	77.0	1000	6.9	1.92	2.86
20032406	2½	63.5	3.48	88.4	800	5.5	2.18	3.24
20032476	3	76.2	4.02	102.1	800	5.5	2.66	3.96

**Air & Multipurpose**  
General Purpose  
Heavy Duty  
Push-on

Chemical Transfer

Cleaning Equipment

**Food**  
Transfer  
Washdown

Marine

**Material Handling**  
Abrasives  
Bulk Transfer  
Cement & Concrete

Mining

**Petroleum**  
Aircraft Fueling  
Dispensing  
Dock  
Transfer

Spray

Steam

Vacuum

LPG Delivery

**Water**  
Discharge  
Suction & Discharge  
Washdown

Welding

Coupling Systems

Equipment

Appendix

# Allcrete® Textile Plaster, Grout & Concrete



## Product Specifications

### Application

For use in plaster & grout and shotcrete applications, handling a multitude of materials being pumped to concrete structures, dams, tunnel faces, swimming pools, etc. For use as a flexible connection between pumping equipment and hard piping. Exceeds ASME B30.27-2009. 2:1 WP to burst ratio.

### Construction Tube

Black ChemiTuf® synthetic rubber

### Cover

Black SBR rubber (wrapped impression)

### Reinforcement

Spiral-plied high-strength fabric

### Temperature Range

-25°F to 180°F (-32°C to 82°C)

### Packaging

50' lengths, coiled and polywrapped

### Branding (Spiral)

Example: Allcrete® Textile Ply Plaster, Grout and Concrete Continental ContiTech 2" 1233 psi / 85 Bars WP. Weight filled with concrete (150 lbs/ft³). Exceeds ASME B30.27-2009

### Couplings

Contact fitting manufacturer for proper fitting recommendation and coupling procedure.

### Order Codes

549-638, Survivor 549-802

## Allcrete® Textile

SAP #	ID	Nom. OD		Max. WP		Weight			
Black	Survivor Compound	in.	mm	in.	mm	psi	MPa	lb./ft.	kg/m
20019934	20677614	1	25.4	1.67	42.3	1233	8.5	0.67	1.00
20019938		1¼	32.0	1.93	49.0	1233	8.5	0.80	1.19
20019942	20673536	1½	38.1	2.31	58.7	1233	8.5	1.14	1.70
20019947	20673537 (50ft) 20673538 (100ft)	2	51.6	2.83	71.8	1233	8.5	1.46	2.18
20019960	20673539	2½	63.7	3.40	86.3	1233	8.5	1.96	2.92
20019965	20673580	3	76.1	3.92	99.6	1233	8.5	2.39	3.56
20019971		4	102.1	4.96	126.0	1233	8.5	3.16	4.67
20164566		5	127.0	6.06	153.3	1233	8.5	4.22	6.25

Air & Multipurpose  
General Purpose  
Heavy Duty  
Push-on

Chemical Transfer

Cleaning Equipment

Food  
Transfer  
Washdown

Marine

**Material Handling**  
Abrasives  
Bulk Transfer  
Cement & Concrete

Mining

Petroleum  
Aircraft Fueling  
Dispensing  
Dock  
Transfer

Spray

Steam

Vacuum

LPG Delivery

Water  
Discharge  
Suction & Discharge  
Washdown

Welding

Coupling Systems

Equipment

Appendix



# Allcrete® Wire



## Product Specifications

### Application

For handling wet concrete with high head pressures at the critical flex areas of a concrete boom truck and as a discharge hose on the delivery end of high-pressure concrete pumps. Exceeds ASME B30.27-2009, 2:1 WP to burst ratio.

### Construction Tube

Black ChemiTuf® synthetic rubber

### Cover

Black SBR rubber (wrapped impression)

### Reinforcement

Spiral-plied high-strength wire

### Temperature Range

-40°F to 180°F (-40°C to 82°C)

### Packaging

50' lengths, coiled and polywrapped

### Branding (Spiral)

Allcrete® Steel Reinforced Concrete Hose Continental ContiTech 3" ID 1233 psi / 85 Bars WP. Weight filled with concrete (150 lbs/ft<sup>3</sup>). Exceeds ASME B30.27-2009

### Couplings

Contact fitting manufacturer for proper fitting recommendation and coupling procedure.

### Order Codes

549-670

### Allcrete® Wire

SAP #	ID		Nom. OD		Max. WP		Bend Radius		Weight	
	in.	mm	in.	mm	psi	MPa	in.	mm	lb./ft.	kg/m
20032690	2	50.8	3.01	76.4	1233	8.5	9	275	2.75	4.10
20672114	2½	63.5	3.50	88.9	1233	8.5	12	300	3.28	4.92
20020019	3	76.2	3.98	101.3	1233	8.5	14	350	3.80	5.65
20020022	4	101.6	5.02	127.4	1233	8.5	16	400	4.90	7.29
20020026	5	127.0	6.00	152.5	1233	8.5	20	500	5.98	8.90

**Air & Multipurpose**  
General Purpose  
Heavy Duty  
Push-on

Chemical Transfer

Cleaning Equipment

**Food**  
Transfer  
Washdown

Marine

**Material Handling**  
Abrasives  
Bulk Transfer  
Cement & Concrete

Mining

**Petroleum**  
Aircraft Fueling  
Dispensing  
Dock  
Transfer

Spray

Steam

Vacuum

LPG Delivery

**Water**  
Discharge  
Suction & Discharge  
Washdown

Welding

Coupling Systems

Equipment

Appendix

# PGC Placement Textile



## Product Specifications

### Application

An economical version of our Plicord® Allcrete® Textile hose. For use in plaster & grout and shotcrete applications, handling a multitude of materials being pumped to concrete structures, dams, tunnel faces, swimming pools, etc. Meets ASME B30.27-2009, 2:1 WP to burst ratio.

### Construction Tube

Black ChemiTuf® synthetic rubber

### Cover

Black SBR rubber (wrapped impression).

### Reinforcement

Spiral-plied high-strength fabric.

### Temperature Range

-25°F to 180°F (-32°C to 82°C)

### Packaging

50' lengths, coiled and polywrapped.

### Branding (Spiral)

Continental ContiTech PGC Concrete 1,233 psi / 85 Bars WP

### Couplings

Contact fitting manufacturer for proper fitting recommendation and coupling procedure.

### Order Codes

549-822

## PGC Placement Textile

SAP #	ID	Nom. OD		Max. WP		Weight		
		in.	mm	in.	mm	lb./ft.	kg/m	
20560651	1	25.3	1.56	39.7	1,233	8.5	0.58	0.86
20560652	1¼	32.0	1.88	47.7	1,233	8.5	0.76	1.13
20528827	1½	38.0	2.13	53.7	1,233	8.5	0.87	1.30
20528900	2	51.2	2.69	67.1	1,233	8.5	1.13	1.68
20528902	2½	63.4	3.25	82.3	1,233	8.5	1.59	2.37
20528904	3	76.1	3.81	96.8	1,233	8.5	2.12	3.16
20560653	3½	90.0	4.38	111.9	1,233	8.5	2.63	3.92
20560654	4	102.0	4.94	125.6	1,233	8.5	3.10	4.62

Air & Multipurpose

General Purpose

Heavy Duty

Push-on

Chemical Transfer

Cleaning Equipment

Food

Transfer

Washdown

Marine

Material Handling

Abrasives

Bulk Transfer

Cement & Concrete

Mining

Petroleum

Aircraft Fueling

Dispensing

Dock

Transfer

Spray

Steam

Vacuum

LPG Delivery

Water

Discharge

Suction & Discharge

Washdown

Welding

Coupling Systems

Equipment

Appendix

# Plicord® Guniting Tan



## Product Specifications

### Application

For the efficient transfer of sand and cement to the placement mixing gun nozzle. Recommended for all types of gunning applications.

### Construction Tube

Tan Pureten™ gum rubber or black ChemiTuf® rubber

### Cover

Tan SBR synthetic rubber (wrapped impression)

### Reinforcement

Spiral-plied synthetic fabric

### Temperature Range

-40°F to 180°F (-40°C to 82°C)

### Packaging

50' lengths, coiled and polywrapped

### Branding (Spiral)

Example: Continental ContiTech Guniting 150 Max WP

### Couplings

Contact fitting manufacturer for proper fitting recommendation and coupling procedure.

### Order Codes

549-862 (tan Pureten™)

549-863 (black ChemiTuf®)

549-865 (tan Pureten™ with anti-static wires)

## Plicord® Guniting

SAP #			ID		Nom. OD		Max. WP		Weight	
Tan Pureten	Black ChemiTuf®	Tan Pureten with anti-static wires	in.	mm	in.	mm	psi	MPa	lb./ft.	kg/m
20020272			1¼	31.8	2.16	54.9	150	1.03	1.24	1.85
20020274	20020282	20020287	1½	38.1	2.43	61.7	150	1.03	1.48	2.20
20020277		20020290	1⅝	41.3	2.58	65.5	150	1.03	1.60	2.38
20020278			1¾	44.5	2.70	68.6	150	1.03	1.68	2.50
20020279	20020283	20020291	2	50.8	2.94	74.7	150	1.03	1.86	2.77

**Air & Multipurpose**  
General Purpose  
Heavy Duty  
Push-on

Chemical Transfer

Cleaning Equipment

**Food**  
Transfer  
Washdown

Marine

**Material Handling**  
Abrasives  
Bulk Transfer  
Cement & Concrete

Mining

**Petroleum**  
Aircraft Fueling  
Dispensing  
Dock  
Transfer

Spray

Steam

Vacuum

LPG Delivery

**Water**  
Discharge  
Suction & Discharge  
Washdown

Welding

Coupling Systems

Equipment

Appendix

# Mining



	Page	Thermo-plastic	Rubber	MSHA	Temp. Range	Static Dissipating Tube
Brigade Mine	142	Yes		Yes	-10°F to 150°F (-23°C to 66°C)	
Flextra Rock Dust	143		Yes	Yes	-25°F to 200°F (-32°C to 93°C)	Yes
M&P Mine Conduit	144		Yes	Yes	-20°F to 200°F (-29°C to 93°C)	
Mine Spray	141		Yes	Yes	0°F to 200°F (-18°C to 93°C)	
Plicord Ammonium Nitrate HD	146		Yes		-25°F to 200°F (-32°C to 93°C)	Yes
Plicord Ammonium Nitrate Pellet	145		Yes		-25°F to 200°F (-32°C to 93°C)	Yes
Plicord Mine Conduit	147		Yes	Yes	-40°F to 200°F (-40°C to 93°C)	
Spiraflex Cable Guard	148	Yes		Yes	0°F to 150°F (-18°C to 66°C)	
Spiraflex Red	233	Yes		Yes	-10°F to 150°F (-23°C to 66°C)	
Spiraflex Rock Dust	149	Yes		Yes	0°F to 158°F (-18°C to 70°C)	
Spiraflex Yellow	234	Yes		Yes	-10°F to 150°F (-23°C to 66°C)	

## Air & Multipurpose

General Purpose

Heavy Duty

Push-on

Chemical Transfer

Cleaning Equipment

## Food

Transfer

Washdown

Marine

## Material Handling

Abrasives

Bulk Transfer

Cement &amp; Concrete

## Mining

## Petroleum

Aircraft Fueling

Dispensing

Dock

Transfer

Spray

Steam

Vacuum

LPG Delivery

## Water

Discharge

Suction &amp; Discharge

Washdown

Welding

Coupling Systems

Equipment

Appendix

# Mine Spray



## Product Specifications

### Application

For general underground water spray service in dust control applications. It is also used on continuous mining machinery at the headface and on other mechanical mining machines.

### Construction Tube

Nitrile synthetic rubber RMA Class B (Medium Oil Resistance)

### Cover

Yellow Chemivic™ synthetic rubber RMA Class B (Medium Oil Resistance) (Meets flame test requirements of MSHA Schedule 26-Section 18.65), smooth finish

### Reinforcement

Braided (1) steel wire

### Temperature Range

0°F to 200°F (-18°C to 93°C)

### Packaging

3/4" - 500' reels or 50' cut lengths, 20 pieces per carton

1" - 500' reels or 50' cut lengths, 12 pieces per carton

1¼" - 500' reels or 50' cut lengths, 8 pieces per carton

1½" - 300' reels or 50' cut lengths, 6 pieces per carton

2" - 50' cut lengths, 4 pieces per carton

### Branding (Spiral)

Example: Continental ContiTech 1" Mine Spray 1000 psi WP, Fire-Resistant, USMSHA IC-11/9. Made in U.S.A.

### Couplings

Contact fitting manufacturer for proper fitting recommendation and coupling procedure.

### Order Codes

539-421

## Mine Spray

SAP #	ID		Nom. OD		Max. WP		Weight	
	in.	mm	in.	mm	psi	MPa	lb./ft.	kg/m
20024121	3/4	19.1	1.14	29.0	1000	6.9	0.44	0.65
20024129	1	25.4	1.45	36.8	1000	6.9	0.63	0.94
20024138	1¼	31.8	1.75	44.5	1000	6.9	0.86	1.28
20024143	1½	38.1	1.98	50.3	1000	6.9	1.08	1.61
20024154	2	50.8	2.55	64.8	1000	6.9	1.57	2.34

**Air & Multipurpose**  
General Purpose  
Heavy Duty  
Push-on

Chemical Transfer

Cleaning Equipment

**Food**  
Transfer  
Washdown

Marine

**Material Handling**  
Abrasives  
Bulk Transfer  
Cement & Concrete

Mining

**Petroleum**  
Aircraft Fueling  
Dispensing  
Dock  
Transfer

Spray

Steam

Vacuum

LPG Delivery

**Water**  
Discharge  
Suction & Discharge  
Washdown

Welding

Coupling Systems

Equipment

Appendix

# Brigade™ Mine



**Air & Multipurpose**

- General Purpose
- Heavy Duty
- Push-on

Chemical Transfer

Cleaning Equipment

**Food**

- Transfer
- Washdown

Marine

**Material Handling**

- Abrasives
- Bulk Transfer
- Cement & Concrete

**Mining**

**Petroleum**

- Aircraft Fueling
- Dispensing
- Dock Transfer

Spray

Steam

Vacuum

LPG Delivery

**Water**

- Discharge
- Suction & Discharge
- Washdown

Welding

Coupling Systems

Equipment

Appendix

## Product Specifications

**Application**

For use as a mine fire protection hose in underground mines.

**Construction Tube**

Black fire-resistant Pliovic®

**Cover**

Orange fire-resistant Pliovic®

**Reinforcement**

Spiral synthetic yarn

**Temperature Range**

-10°F to 150°F (-23°C to 66°C)

**Packaging**

- 1½" - 500' continuous one piece, coiled and banded
- 2" - 400' continuous one piece, coiled and banded
- 2½" - 300' continuous one piece, coiled and banded

**Branding (Spiral)**

Example: Continental ContiTech Brigade™ Mine Flame-Resistant, USMSHA No. 2G14, 2" (52.6mm) 150 psi (1.03 MPa). Made in U.S.A.

**Couplings**

Contact fitting manufacturer for proper fitting recommendation and coupling procedure.

**Order Codes**

- 537-506 (150 psi)
- 537-508 (200 psi)

### Brigade™ Mine

SAP #	ID		Nom. OD		Max. WP		Weight	
	Orange	in.	mm	in.	mm	psi	MPa	lb./ft.
20012419	1½	38.1	1.75	44.5	150	1.03	0.23	0.34
20012427	2	50.8	2.27	57.7	150	1.03	0.34	0.51
20012429	2½	63.5	2.83	71.9	150	1.03	0.51	0.76
20012456	1½	38.1	1.72	43.7	200	1.38	0.25	0.37
20012461	2	50.8	2.29	58.2	200	1.38	0.36	0.54
20012463	2½	63.5	2.68	68.1	200	1.38	0.51	0.76

# Flextra® Rock Dust



## Product Specifications

### Application

For handling rock dust operations in underground mines.

### Construction Tube

Black ChemiTuf® synthetic rubber (static dissipating/static conductive)

### Cover

Yellow Chemivic™ synthetic rubber, flame-resistant (MSHA) (wrapped impression)

### Reinforcement

Spiral-plied synthetic fabric with wire helix

### Temperature Range

-25°F to 200°F (-32°C to 93°C)

### Packaging

50' lengths, coiled and polywrapped

### Branding (Spiral)

Example: Continental ContiTech Rock Dust Flame-Resistant MSHA IC 11/7

### Couplings

Contact fitting manufacturer for proper fitting recommendation and coupling procedure. Soft-cuffed ends available upon special request.

### Order Codes

549-668

## Flextra® Rock Dust

SAP #	ID		Nom. OD		Max. WP		Bend Radius		Vacuum HG		Weight	
	in.	mm	in.	mm	psi	MPa	in.	mm	in.	mm	lb./ft.	kg/m
20020003	1¼	31.8	1.59	40.5	100	0.69	6	152	29	737	0.48	0.72
20020005	1½	38.1	1.85	46.9	100	0.69	6	152	29	737	0.60	0.89
20020009	2	50.8	2.37	60.3	100	0.69	8	203	29	737	0.80	1.19
20020011	2½	63.5	2.89	73.3	100	0.69	10	254	29	737	1.06	1.58
20020012	3	76.2	3.35	85.1	50	0.34	12	305	29	737	1.20	1.79
20020013	4	101.6	4.41	111.9	50	0.34	16	406	29	737	1.71	2.55

**Air & Multipurpose**  
General Purpose  
Heavy Duty  
Push-on

Chemical Transfer

Cleaning Equipment

**Food**  
Transfer  
Washdown

Marine

**Material Handling**  
Abrasives  
Bulk Transfer  
Cement & Concrete

Mining

**Petroleum**  
Aircraft Fueling  
Dispensing  
Dock  
Transfer

Spray

Steam

Vacuum

LPG Delivery

**Water**  
Discharge  
Suction & Discharge  
Washdown

Welding

Coupling Systems

Equipment

Appendix

# M&P Mine Conduit



## Product Specifications

### Application

A fabric-reinforced conduit hose for use as an electrical cable cover in underground mine service.

### Branding

Example: 3/4" (19.1mm) Mine Conduit. Made in U.S.A. Continental ContiTech. US MSHA #2G-14-7X

### Construction Tube

Black flame-resistant synthetic

### Couplings

Contact fitting manufacturer for proper fitting recommendation and coupling procedure.

### Cover

Black flame-resistant synthetic (smooth cover)

### Order Codes

569-045

### Reinforcement

Spiral synthetic yarn

### Temperature Range

-20°F to 200°F (-29°C to 93°C)

### Packaging

Stocked in 50' pieces per box

## M&P Mine Conduit

SAP #	ID		Nom. OD		Weight	
	in.	mm	in.	mm	lb./ft.	kg/m
20026402	1/2	12.7	0.94	23.9	0.29	0.43
20026405	5/8	15.9	1.06	26.9	0.35	0.52
20026409	3/4	19.1	1.19	30.2	0.39	0.58
20026412	7/8	22.2	1.32	33.5	0.45	0.67
20026415	1	25.4	1.43	36.3	0.46	0.68
20026417	1 1/8	28.6	1.56	39.6	0.60	0.89
20026419	1 1/4	31.8	1.69	42.9	0.62	0.92
20026421	1 3/8	34.9	1.82	46.2	0.71	1.06
20026423	1 1/2	38.1	1.95	49.5	0.75	1.12

### Air & Multipurpose

General Purpose  
Heavy Duty  
Push-on

### Chemical Transfer

### Cleaning Equipment

Food  
Transfer  
Washdown

### Marine

### Material Handling

Abrasives  
Bulk Transfer  
Cement & Concrete

### Mining

### Petroleum

Aircraft Fueling  
Dispensing  
Dock  
Transfer

### Spray

### Steam

### Vacuum

### LPG Delivery

### Water

Discharge  
Suction & Discharge  
Washdown

### Welding

### Coupling Systems

### Equipment

### Appendix



# Plicord® Ammonium Nitrate Pellet



## Product Specifications

### Application

For pellet transfer in blasting hole loading.

### Construction Tube

Black Nitrile synthetic rubber (static dissipating/  
static conductive)

### Cover

Black Nitrile synthetic rubber (static dissipating/  
static conductive)

### Reinforcement

Spiral-plied synthetic fabric

### Temperature Range

-25°F to 200°F (-32°C to 93°C)

### Packaging

100' lengths, coiled and polywrapped

### Branding (Spiral)

Example: Continental ContiTech Ammonium Nitrate Pellet  
100 psi

### Couplings

Contact fitting manufacturer for proper fitting  
recommendation and coupling procedure.

### Order Codes

549-232

## Plicord® Ammonium Nitrate Pellet

SAP #	ID		Nom. OD		Max. WP		Weight	
	in.	mm	in.	mm	psi	MPa	lb./ft.	kg/m
20019417	3/4	19.1	1.17	29.7	100	0.69	0.33	0.49
20019420	1	25.4	1.42	36.1	100	0.69	0.34	0.51
20019422	1½	38.1	1.92	48.8	100	0.69	0.59	0.88
20105656	2	50.8	2.49	63.3	100	0.69	0.76	1.13
20133606	2½	63.5	2.94	74.7	100	0.69	0.90	1.34
20032691	3	76.2	3.42	86.9	100	0.69	1.10	1.64

**Air & Multipurpose**  
General Purpose  
Heavy Duty  
Push-on

Chemical Transfer

Cleaning Equipment

**Food**  
Transfer  
Washdown

Marine

**Material Handling**  
Abrasives  
Bulk Transfer  
Cement & Concrete

Mining

**Petroleum**  
Aircraft Fueling  
Dispensing  
Dock  
Transfer

Spray

Steam

Vacuum

LPG Delivery

**Water**  
Discharge  
Suction & Discharge  
Washdown

Welding

Coupling Systems

Equipment

Appendix

# Plicord® Ammonium Nitrate HD



## Product Specifications

### Application

A heavy duty hose for pellet transfer in blasting hole loading. Capable of handling -25°F to 200°F (-32°C to 93°C).

### Construction Tube

Black Nitrile synthetic rubber (static dissipating/ static conductive)

### Cover

Black Nitrile synthetic rubber (static dissipating/ static conductive) (wrapped impression)

### Recommended Fittings

Contact fitting manufacturer for proper fitting recommendation and coupling procedure

### Reinforcement

Spiral-plied synthetic fabric recommendation and coupling procedure

### Temperature Range

-25°F to 200°F (-32°C to 93°C)

### Packaging

Coiled and polywrapped

### Branding

Continuous spiral brand \*HD Ammonium nitrate pellet 400 psi map WP Continental ContiTech Made in Canada.

### Non-Stock/Sizes

Maximum shipping length 400'

### Order Codes

549-231-0

## Plicord® Ammonium Nitrate HD

SAP #	DIA	ID	OD	Weight
Black	PO	mm	mm	lb./ft
20019420	1	25.3	39.7	0.58
20019422	1½	38.0	52.4	0.81
20118678	2	51.2	71.6	1.56
20135894	2½	63.7	81.7	1.62
20032691	3	76.1	92.9	1.76

### Air & Multipurpose

General Purpose  
Heavy Duty  
Push-on

### Chemical Transfer

### Cleaning Equipment

Food  
Transfer  
Washdown

### Marine

### Material Handling

Abrasives  
Bulk Transfer  
Cement & Concrete

### Mining

### Petroleum

Aircraft Fueling  
Dispensing  
Dock  
Transfer

### Spray

### Steam

### Vacuum

### LPG Delivery

Water  
Discharge  
Suction & Discharge  
Washdown

### Welding

### Coupling Systems

### Equipment

### Appendix

# Plicord® Mine Conduit



## Product Specifications

### Application

A fabric-reinforced hose for use as an electrical cable cover in underground mines. Meets MSHA standards for flame-resistant cover.

### Construction Tube

Black Wingprene® synthetic rubber

### Cover

Black Wingprene® synthetic rubber, flame-resistant (wrapped impression)

### Reinforcement

Spiral-plied synthetic fabric

### Temperature Range

-40°F to 200°F (-40°C to 93°C)

### Packaging

50' lengths, coiled and polywrapped

### Branding (Spiral)

Example: Continental ContiTech Mine Conduit Hose, Flame-Resistant, USMSHA, #2G-14/15

### Couplings

Contact fitting manufacturer for proper fitting recommendation and coupling procedure.

### Order Codes

549-039 (black cover)  
549-035 (yellow cover)

## Plicord® Mine Conduit

SAP #		ID		Nom. OD		Weight	
Black	Yellow	in.	mm	in.	mm	lb./ft.	kg/m
20019080	20019068	1/2	12.7	0.94	23.9	0.30	0.45
20019082	20019070	5/8	15.9	1.06	26.9	0.35	0.52
20019084	20019071	3/4	19.1	1.18	30.0	0.40	0.60
20019087	20019072	7/8	22.2	1.30	33.0	0.45	0.67
20019089	20019073	1	25.4	1.43	36.3	0.50	0.74
20019091	20019075	1 1/8	28.6	1.58	40.1	0.56	0.83
20019093	20045963	1 1/4	31.8	1.69	42.9	0.61	0.91
20019095	20031917	1 3/8	34.9	1.81	46.0	0.66	0.98
20019096	20029879	1 1/2	38.1	1.93	49.0	0.71	1.06
20019099	20031918	1 3/4	44.5	2.21	56.1	0.82	1.22
20019102	20019076	2	50.8	2.42	61.5	0.87	1.29
20019107		2 1/4	57.2	2.67	67.9	0.97	1.43
20019108		2 3/8	60.3	2.80	71.0	1.02	1.52
20019109	20029631	2 1/2	63.5	2.92	74.2	1.06	1.58
20019112		3	76.2	3.41	86.5	1.26	1.86
20019115		4	101.6	4.44	112.7	1.66	2.45

**Air & Multipurpose**  
General Purpose  
Heavy Duty  
Push-on

Chemical Transfer

Cleaning Equipment

**Food**  
Transfer  
Washdown

Marine

**Material Handling**  
Abrasives  
Bulk Transfer  
Cement & Concrete

Mining

**Petroleum**  
Aircraft Fueling  
Dispensing  
Dock  
Transfer

Spray

Steam

Vacuum

LPG Delivery

**Water**  
Discharge  
Suction & Discharge  
Washdown

Welding

Coupling Systems

Equipment

Appendix

# SpiraFlex® Cable Guard

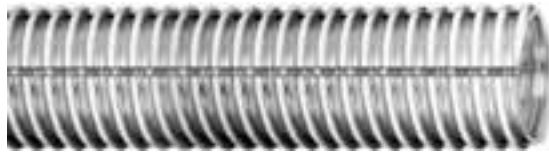

## Product Specifications

### Application

For use as a protective cover for supply lines. Flame-resistant MSHA approved.

### Branding

Example: Cable Guard, USMSHA IC-11/12. Made in U.S.A. Continental ContiTech

### Construction Tube

Clear Pliovic® corrugated for flexibility, MSHA

### Order Codes

586-438

### Helix

Clear Pliovic® corrugated for flexibility, MSHA

### Temperature Range

0°F to 150°F (-18°C to 66°C)

### Packaging

Continuous one piece, coiled and polywrapped, available in 50' or 100' lengths, available preslit longitudinally for easy installation.

## SpiraFlex® Cable Guard

SAP #	ID		Nom. OD		Bend Radius		Weight	
	in.	mm	in.	mm	psi	MPa	lb./ft.	kg/m
20013419	2	50.8	2.28	57.9	3	76	0.34	0.51
20013425	3	76.2	3.37	85.6	6	152	0.52	0.77
20013431	4	101.6	4.44	112.8	9	229	0.75	1.12

#### Air & Multipurpose

General Purpose

Heavy Duty

Push-on

Chemical Transfer

Cleaning Equipment

#### Food

Transfer

Washdown

Marine

#### Material Handling

Abrasives

Bulk Transfer

Cement & Concrete

Mining

#### Petroleum

Aircraft Fueling

Dispensing

Dock

Transfer

Spray

Steam

Vacuum

LPG Delivery

#### Water

Discharge

Suction & Discharge

Washdown

Welding

Coupling Systems

Equipment

Appendix

# SpiraFlex® Rock Dust



## Product Specifications

### Application

Rock Dust hose is a lightweight, flexible alternative to the rubber hose for handling rock dusting in underground coal mines.

### Construction Tube

Green Pliovic®, meets MSHA standards USMSHA

### Cover

Green Pliovic®, meets MSHA standards USMSHA

### Reinforcement

Rigid white Pliovic® PVC helix

### Temperature Range

0°F to 158°F (-18°C to 70°C)

### Packaging

100' lengths, coiled and polywrapped

### Branding

Example: Rock Dust USMSHA 2G-1C-14C/17. Made in U.S.A. Continental ContiTech

### Couplings

Contact fitting manufacturer for proper fitting recommendation and coupling procedure.

### Non-Stock/Sizes

Static wire available, contact Customer Service.

### Order Codes

586-426 (corrugated cover)

586-427 (smooth cover with static wire, not available in 4")

## SpiraFlex® Rock Dust

SAP #	Green	Smooth cover w/ static wire	ID		Nom. OD		Max. WP		Bend Radius		Vacuum HG		Weight	
			in.	mm	in.	mm	psi	MPa	in.	mm	in.	mm	lb./ft.	kg/m
20013351	20766499		1½	38.1	1.75	44.5	44	0.30	4	97	29	737	0.28	0.42
20013354	20013361		2	50.8	2.35	59.7	30	0.21	6	140	29	737	0.61	0.91
20013356	20013363		2½	63.5	2.87	72.9	30	0.21	7	178	29	737	0.61	0.91
20013358	20013365		3	76.2	3.40	86.4	30	0.21	8	203	29	737	0.77	1.15
20013359	20645908		4	101.6	4.45	113.0	27	0.19	14	356	15	381	0.95	1.41

**Air & Multipurpose**  
General Purpose  
Heavy Duty  
Push-on

Chemical Transfer

Cleaning Equipment

**Food**  
Transfer  
Washdown

Marine

**Material Handling**  
Abrasives  
Bulk Transfer  
Cement & Concrete

Mining

**Petroleum**  
Aircraft Fueling  
Dispensing  
Dock  
Transfer

Spray

Steam

Vacuum

LPG Delivery

**Water**  
Discharge  
Suction & Discharge  
Washdown

Welding

Coupling Systems

Equipment

Appendix

# Aircraft Fueling



**Air & Multipurpose**  
 General Purpose  
 Heavy Duty  
 Push-on

Chemical Transfer

Cleaning Equipment

**Food**  
 Transfer  
 Washdown

Marine

**Material Handling**  
 Abrasives  
 Bulk Transfer  
 Cement & Concrete

Mining

**Petroleum**  
 Aircraft Fueling  
 Dispensing  
 Dock  
 Transfer

Spray

Steam

Vacuum

LPG Delivery

**Water**  
 Discharge  
 Suction & Discharge  
 Washdown

Welding

Coupling Systems

Equipment

Appendix

	Page	API 1529	NFPA	EN 1361	Static Dissipating Cover
Advantage	154	Yes	Yes		Yes
Deadman Aircraft Refueling	155				
Jet Ranger	153	Yes	Yes	Yes	Yes
Platinum JAC Riser	151	Yes		Yes	Yes
Refueling Sensing	156				
Wingcraft	152	Yes	Yes		Yes

# Platinum JAC Riser Hose



Designed for aircraft refuelers equipped with moveable service platforms to act as a flexible connections between the platform and the refueling truck.

» In a flex test of repetitive bend cycles, the leading competitor's JAC Riser product broke down at 63,600 cycles, which resulted in tube and ply separation, loss of electrical conductivity and overall kinking.

» After 124,000 cycles on the same test, the Platinum JAC Riser had no tube separation, maintained its electrical conductivity and experienced no kinking. The test was stopped at 124,000 cycles and the integrity of the hose was still intact.

## Product Specifications

### Application

Commercial and private aircraft fueling/defueling of avgas jet fuel

### Temperature Range

-35°F to 200°F (-37°C to 93°C)

### Construction Tube

Black Nitrile synthetic rubber

### Packaging

Cut lengths, coiled and polywrapped.

### Cover

Black Wingprene® (ORS) static dissipating/static conductive synthetic rubber

### Order Codes

543-244

### Reinforcement

Spiral-plied synthetic fabric

## Platinum JAC Riser Hose

SAP #	ID		Max. WP		Weight	
	in.	mm	psi	MPa	lb./ft.	kg/m
20683391	2	50.8	300	2.07	1.43	2.13
20683393	3	76.2	300	2.07	2.02	3.01
20672228	4	101.6	300	2.07	2.89	4.3

**Air & Multipurpose**  
General Purpose  
Heavy Duty  
Push-on

Chemical Transfer

Cleaning Equipment

**Food**  
Transfer  
Washdown

Marine

**Material Handling**  
Abrasives  
Bulk Transfer  
Cement & Concrete

Mining

**Petroleum**  
Aircraft Fueling  
Dispensing  
Dock  
Transfer

Spray

Steam

Vacuum

LPG Delivery

**Water**  
Discharge  
Suction & Discharge  
Washdown

Welding

Coupling Systems

Equipment

Appendix

# Wingcraft™



## Product Specifications

### Application

For fueling or defueling\* commercial and private aircraft. It handles jet fuel and the higher aromatic aviation gasolines. Its high working pressure permits use in fuel cart hydrant service. Hose meets API Bulletin 1529-6th edition, 2005 and N.F.P.A. Bulletin #407 (2007 revision).

### Construction Tube

Black Nitrile synthetic rubber

### Cover

Black Wingprene® (ORS) static dissipating/static conductive synthetic rubber

### Reinforcement

Spiral-plyed synthetic fabric

### Temperature Range

-35°F to 200°F (-37°C to 93°C)

### Packaging

Cut lengths, coiled and polywrapped

### Branding

Example: Continental ContiTech Wingcraft™ Aircraft Fueling NFPA407, API/IP 1529/2005 Type C, Grade 2, 2", 2000 kPa (300 psi) MAX WP

### Couplings

Contact fitting manufacturer for proper fitting recommendation and coupling procedures.

### Non-Stock/Sizes

Custom lengths and fitting configurations available.

### Order Codes

543-738 (1" to 3")

541-738 (4")

## Wingcraft™

SAP #	ID		Nom. OD		Max. WP		Weight	
	in.	mm	in.	mm	psi	MPa	lb./ft.	kg/m
20018117	1	25.4	1.58	40.1	300	2.07	0.63	0.94
20140101	1¼	31.8	1.89	48.0	300	2.07	0.84	1.25
20016730	1½	38.1	2.13	54.1	300	2.07	0.96	1.43
20016784	2	50.8	2.72	69.1	300	2.07	1.43	2.13
20016778	2½	63.5	3.22	81.8	300	2.07	1.72	2.56
20016775	3	76.2	3.70	94.0	300	2.07	2.02	3.01
20016776	4	101.6	4.80	121.9	300	2.07	2.89	4.30

Note: Bulk hose and factory assemblies are hydrostatic tested to 600 psi and certified.

\*Gravity defueling only

Air & Multipurpose

General Purpose

Heavy Duty

Push-on

Chemical Transfer

Cleaning Equipment

Food

Transfer

Washdown

Marine

Material Handling

Abrasives

Bulk Transfer

Cement & Concrete

Mining

Petroleum

Aircraft Fueling

Dispensing

Dock

Transfer

Spray

Steam

Vacuum

LPG Delivery

Water

Discharge

Suction & Discharge

Washdown

Welding

Coupling Systems

Equipment

Appendix



# Jet Ranger™



## Product Specifications

### Application

Used in the fueling and defueling\* of commercial and private aircraft. Resistant to jet fuel and higher aromatic aviation gasolines. Also for use on hydrant service. Meets both API 1529-6th edition, 2005 and European Standard BS EN 1361; 2004.

### Construction Tube

Black Nitrile synthetic rubber

### Cover

Black Wingprene® (ORS) static dissipating/static conductive synthetic rubber (wrapped finish)

### Reinforcement

Spiral-plied (4) synthetic fabric and one nylon breaker

### Temperature Range

-35°F to 200°F (-37°C to 93°C)

### Packaging

Cut lengths, coiled and polywrapped

### Branding (Spiral)

Example: Continental ContiTech Jet Ranger™ EN 1361:2004/C/OMEGA, NFPA 407 API/IP 1529/2005 Type C, Grade 2, 2½", 2000 kPa/20 bars/300 psi MAX WP

### Couplings

Contact fitting manufacturer for proper fitting recommendation and coupling procedures.

### Order Codes

543-742 (1" to 3")  
541-742 (4")

## Jet Ranger™

SAP #	ID		Nom. OD		Max. WP		Weight	
	in.	mm	in.	mm	psi	MPa	lb./ft.	kg/m
20018250	1½	38.1	2.06	52.3	300	2.07	0.86	1.28
20046710	1¾	50.0	2.57	65.3	300	2.07	1.14	1.70
20099968	2½	63.5	3.16	80.3	300	2.07	1.53	2.28
20018276	3	76.2	3.64	92.5	300	2.07	1.79	2.66
20016044	4	101.6	5.00	127.0	300	2.07	3.70	5.51

Note: Bulk hose is factory hydrostatic tested to 600 psi.

\*Gravity defueling only.

**Air & Multipurpose**  
General Purpose  
Heavy Duty  
Push-on

Chemical Transfer

Cleaning Equipment

**Food**  
Transfer  
Washdown

Marine

**Material Handling**  
Abrasives  
Bulk Transfer  
Cement & Concrete

Mining

**Petroleum**  
Aircraft Fueling  
Dispensing  
Dock  
Transfer

Spray

Steam

Vacuum

LPG Delivery

**Water**  
Discharge  
Suction & Discharge  
Washdown

Welding

Coupling Systems

Equipment

Appendix

# Advantage™



## Product Specifications

### Application

Advantage™ Aircraft Fueling hose is for over- and under-the-wing fueling of commercial and private aircraft. It handles jet fuel and av-gas up to 50% aromatic content.

### Construction Tube

Black Nitrile synthetic rubber

### Cover

Black Wingprene® (ORS) static dissipating/static conductive synthetic rubber (wrapped impression)

### Reinforcement

Spiral-plied (2) synthetic fabric and one breaker

### Temperature Range

-35°F to 200°F (-37°C to 93°C)

### Packaging

Cut lengths, coiled and polywrapped.

### Branding

Example: Continental ContiTech Advantage™ Aircraft Fueling Hose NFPA407, API/IP 1529/2005 Type C, Grade 1, 1¼", 1000 kPa (150 psi) Max. WP

### Couplings

Contact fitting manufacturer for proper fitting recommendation and coupling procedures.

### Non-Stock/Sizes

Custom lengths and female fitting configurations available.

### Order Codes

543-429

## Advantage™

SAP #	ID		Nom. OD		Max. WP		Weight	
	in.	mm	in.	mm	psi	MPa	lb./ft.	kg/m
20017874	1	25.4	1.55	39.4	150	1.03	0.60	0.89
20017880	1¼	31.8	1.81	46.0	150	1.03	0.72	1.07
20017889	1½	38.1	2.11	53.6	150	1.03	0.96	1.43

Hose meets API Bulletin 1529-6th edition, 2005, Grade 1, Type C and N.F.P.A. Bulletin #407 (2001 revision).

Note: Bulk hose and factory assemblies are hydrostatic tested to 300 psi and certified.

Air & Multipurpose

General Purpose

Heavy Duty

Push-on

Chemical Transfer

Cleaning Equipment

Food

Transfer

Washdown

Marine

Material Handling

Abrasives

Bulk Transfer

Cement & Concrete

Mining

Petroleum

Aircraft Fueling

Dispensing

Dock

Transfer

Spray

Steam

Vacuum

LPG Delivery

Water

Discharge

Suction & Discharge

Washdown

Welding

Coupling Systems

Equipment

Appendix

# Deadman Aircraft Refueling



## Product Specifications

### Application

The double-line Deadman Refueling hose is for automatic shutoff at the operator end of aircraft hydrant and truck refueling systems. Used with pneumatic closed circuit systems commonly referred to as single point pressure refueling. Deadman hose is connected to air-actuated shut-off valves, which are controlled by the refueler technician at all times during aircraft refueling operations.

### Construction Tube

Nitrile synthetic rubber, RMA Class A (High Oil Resistance)

### Cover

Red/Green, Green/Yellow Chemivic™ synthetic rubber, RMA Class A (High Oil Resistance)

### Reinforcement

Spiral synthetic yarn

### Temperature Range

-20°F to 140°F (-29°C to 60°C)

### Packaging

450'-750', maximum 3 pieces, minimum 35'

### Branding (Spiral)

Permanent contrasting black ink on the Red Hose only. Example: 1/4" ID. Aircraft Fueling Deadman. Made in U.S.A. Continental ContiTech

### Couplings

Contact fitting manufacturer for proper fitting recommendation and coupling procedures.

### Order Codes

569-601 (Red/Green)  
569-692 (Green/Yellow)

## Deadman Aircraft Refueling

SAP #		ID		Nom. OD		Max. WP		Weight	
Red/Green	Green/Yellow	in.	mm	in.	mm	psi	MPa	lb./ft.	kg/m
20027376	20477995	1/4	6.4	0.53	13.5	200	1.38	0.2	0.3

**Air & Multipurpose**  
General Purpose  
Heavy Duty  
Push-on

Chemical Transfer

Cleaning Equipment

**Food**  
Transfer  
Washdown

Marine

**Material Handling**  
Abrasives  
Bulk Transfer  
Cement & Concrete

Mining

**Petroleum**  
Aircraft Fueling  
Dispensing  
Dock  
Transfer

Spray

Steam

Vacuum

LPG Delivery

**Water**  
Discharge  
Suction & Discharge  
Washdown

Welding

Coupling Systems

Equipment

Appendix

# Refueling Sensing



## Product Specifications

### Application

The double-line Refueling Sensing hose is for use on pressurized aircraft hydrant fueling systems common at the larger metropolitan airports. The Sensing hose operates in a system where air and fuel from the underground hydrants monitor the flow and pressure of fuel being pumped into the aircraft. The hose carries the deadman function (automatic safety shutdown) and pressure control signals from the dispensing vehicle to the hydrant pit control valve.

### Construction Tube

Nitrile synthetic rubber, RMA Class A (High Oil Resistance)

### Cover

Orange/Black high-quality Hysunite™ synthetic rubber

### Reinforcement

Spiral synthetic yarn

### Temperature Range

-20°F to 140°F (-29°C to 60°C)

### Packaging

450'-750' reels, maximum 3 pieces, minimum 35'

### Branding

Permanent contrasting white ink on black hose only

### Couplings

Contact fitting manufacturer for proper fitting recommendation and coupling procedures.

### Order Codes

(Orange/Black) 569-604

## Refueling Sensing

SAP #	ID		Nom. OD		Max. WP		Weight	
	in.	mm	in.	mm	psi	MPa	lb./ft.	kg/m
20027379	3/8	9.5	0.66	16.8	200	1.38	0.28	0.42

**Air & Multipurpose**

- General Purpose
- Heavy Duty
- Push-on

Chemical Transfer

Cleaning Equipment

- Food Transfer
- Washdown

Marine

**Material Handling**

- Abrasives
- Bulk Transfer
- Cement & Concrete

Mining

**Petroleum**

- Aircraft Fueling
- Dispensing
- Dock Transfer

Spray

Steam

Vacuum

LPG Delivery

**Water**

- Discharge
- Suction & Discharge
- Washdown

Welding

Coupling Systems

Equipment

Appendix

# Dispensing



	<b>CUL and/or Page UL Approved</b>	<b>Gasoline</b>	<b>Diesel</b>	<b>Biodiesel*</b>	<b>Ethanol**</b>	<b>Wire Reinforcement</b>	<b>Textile Reinforcement</b>
Aggie Gas	165	Yes	Yes		Yes		Yes
BC Coldflex	166	Yes	Yes	Yes	Yes		Yes
BC Gasoline	167	Yes	Yes	Yes	Yes		Yes
BC Marina	168	Yes	Yes	Yes	Yes		Yes
DEF Dispensing Hose	170						Yes
Flexsteel Futura Ethan-ALL	169	Yes			Yes	Yes	Yes
Flexsteel Futura	158		Yes	Yes	Yes	Yes	
Flexsteel Futura Low Perm	160		Yes	Yes	Yes	Yes	
Flexsteel Futura HVR	161		Yes	Yes	Yes	Yes	
Flexsteel Futura Vapor Assist	159	Yes	Yes			Yes	
Maxxim Premier	162	Yes	Yes			Yes	
Maxxim Premier Plus	163	Yes	Yes			Yes	
Pacer		Yes	Yes	Yes	Yes		Yes

\*Biodiesel blends up to B20

\*\*Ethanol up to E85

**Air & Multipurpose**  
General Purpose  
Heavy Duty  
Push-on

Chemical Transfer

Cleaning Equipment

**Food**  
Transfer  
Washdown

Marine

**Material Handling**  
Abrasives  
Bulk Transfer  
Cement & Concrete

Mining

**Petroleum**  
Aircraft Fueling  
Dispensing  
Dock  
Transfer

Spray

Steam

Vacuum

LPG Delivery

**Water**  
Discharge  
Suction & Discharge  
Washdown

Welding

Coupling Systems

Equipment

Appendix

# Flexsteel® Futura™



## Product Specifications

### Application

Flexsteel® Futura™ with new Futurin™ cover resists cracking and fading, designed to dispense a wide range of fuels with extreme durability. The wire braid construction provides excellent kink resistance, low computer creep, and long service life. UL 330 and CUL approved.

### Construction Tube

Nitrile synthetic rubber (ORS)

### Cover

Futurin™ synthetic rubber (ORS)

### Reinforcement

Wire braid

### Temperature Range

-40°F to 140°F (-40°C to 60°C)

### Packaging

5/8" and 3/4" – Reels or coupled lengths, 10 pieces per box  
 1" – Reels or coupled lengths, 5 pieces per box

### Branding

Example: Continental ContiTech 559N, Made in U.S.A. 3/4" (19mm) UL, CUL. Listed Flexsteel® Futura™

### Couplings

Contact fitting manufacturer for proper fitting recommendation and coupling procedure.

### Order Codes

532-327

### Flexsteel® Futura™

ID	Nom. OD		Weight		
	in.	mm	in.	mm	lb./ft.
5/8	15.9	1.00	25.4	0.40	0.60
3/4	19.1	1.13	28.7	0.45	0.67
1	25.4	1.38	35.1	0.61	0.91

**Air & Multipurpose**

- General Purpose
- Heavy Duty
- Push-on

Chemical Transfer

Cleaning Equipment

- Food Transfer**
- Washdown

Marine

**Material Handling**

- Abrasives
- Bulk Transfer
- Cement & Concrete

Mining

**Petroleum**

- Aircraft Fueling
- Dispensing
- Dock Transfer

Spray

Steam

Vacuum

LPG Delivery

**Water**

- Discharge
- Suction & Discharge
- Washdown

Welding

Coupling Systems

Equipment

Appendix

# Flexsteel® Futura™ Vapor Assist



## Product Specifications

### Application

For Stage II Vacuum Assist Systems where a pump in the dispenser pulls the gasoline vapors away from the vehicle fill pipe during fueling. The wire-braid construction for the fuel hose provides excellent kink resistance, low computer creep and long service life. Flexsteel® Futura™ Vapor Assist is UL 330 approved.

### Construction Tube

Nitrile synthetic rubber (ORS)

### Cover

Futurin™ synthetic rubber (ORS)

### Reinforcement

Braided (1) steel wire

### Temperature Range

-40°F to 140°F (-40°C to 60°C)

### Packaging

Coupled lengths only, 6 pieces per box

### Branding

Example: 3/4" Continental ContiTech Made in U.S.A. UL Listed Flexsteel® Futura™ Vapor Assist

Example: 7/8" Continental ContiTech Made in U.S.A. UL Listed Flexsteel® Futura™ Vapor Assist

### Couplings

Available only as factory coupled assembly.

### Order Codes

532-362

## Flexsteel® Futura™ Vapor Assist

ID		Nom. OD		Weight	
in.	mm	in.	mm	lb./ft.	kg/m
3/4	19.1	1.13	28.7	0.45	0.67
7/8	22.2	1.25	31.8	0.49	0.73

**Air & Multipurpose**  
General Purpose  
Heavy Duty  
Push-on

Chemical Transfer

Cleaning Equipment

**Food**  
Transfer  
Washdown

Marine

**Material Handling**  
Abrasives  
Bulk Transfer  
Cement & Concrete

Mining

**Petroleum**  
Aircraft Fueling  
Dispensing  
Dock  
Transfer

Spray

Steam

Vacuum

LPG Delivery

**Water**  
Discharge  
Suction & Discharge  
Washdown

Welding

Coupling Systems

Equipment

Appendix

# New Flexsteel® Futura™ Low Perm



## The First UL-Approved Low Permeation Gasoline Dispensing Hose Available to the Market

The Flexsteel® Futura™ Low Perm dispensing hose offers superior, long-lasting service with multi-fuel capability. This hose is designed for use at filling stations to reduce permeation rates to 10 grams/m<sup>2</sup>/day and improve air quality and emissions.

- › Premium abuse-resistant cover compound with enhanced ozone resistance for service longevity
- › Meets UL330 requirements for conventional and vapor recovery
- › Meets stringent permeation requirements of less than 10 grams/m<sup>2</sup>/day

**The Flexsteel® Futura™ Low Perm dispensing hose is the only low permeation gasoline hose available with the following specifications:**

**Product Code**

532-338-024

**Dimensions**

Size.	ID in.	OD in.	Working Pressure
3/4	0.720-0.780"	1.115-1.165"	50 psi

**Tube**

Nitrile synthetic rubber with Fluorothermoplastice barrier layer

**Braid**

Single wire braid

**Cover**

Futurin™ synthetic rubber

**Permeation**

Meets UL330 permeation limit of 10 grams/m<sup>2</sup>/day

**Branding**

Listed to UL330.

3/4" Straight and Swivels available with NPT threads.

**Air & Multipurpose**

- General Purpose
- Heavy Duty
- Push-on

Chemical Transfer

Cleaning Equipment

**Food**

- Transfer
- Washdown

Marine

**Material Handling**

- Abrasives
- Bulk Transfer
- Cement & Concrete

Mining

**Petroleum**

- Aircraft Fueling
- Dispensing
- Dock Transfer

Spray

Steam

Vacuum

LPG Delivery

**Water**

- Discharge
- Suction & Discharge
- Washdown

Welding

Coupling Systems

Equipment

Appendix



# Flexsteel® Futura™ HVR



## Product Specifications

### Application

- › Premium abuse-resistant cover compound with enhanced ozone resistance for service longevity
- › Meets UL330, CARB, ORVR and EVR requirements
- › Factory-made assemblies with fittings designed for Healy Stage II Enhanced Vapor Recovery (EVR) Systems compatibility

### Construction Tube

Nitrile synthetic rubber (ORS)

### Cover

Futurin™ synthetic rubber (ORS)

### Reinforcement

Braided (1) steel wire

### Temperature Range

-40°F to 140°F (-40°C to 60°C)

### Packaging

Coupled lengths only, 6 pieces per box

### Branding

Example: 3/4" Continental ContiTech Made in U.S.A., UL Listed Flexsteel® Futura™ HVR Continental ContiTech Made in U.S.A.,

### Couplings

Available only as factory coupled assembly.

### Non-Stock/Sizes

For special production run minimum requirements, contact customer service

### Order Codes

532-330

## Flexsteel® Futura™ HVR

ID		Nom. OD		Weight	
in.	mm	in.	mm	lb./ft.	kg/m
3/4	19.1	1.13	28.7	0.45	0.67

**Air & Multipurpose**  
General Purpose  
Heavy Duty  
Push-on

Chemical Transfer

Cleaning Equipment

**Food**  
Transfer  
Washdown

Marine

**Material Handling**  
Abrasives  
Bulk Transfer  
Cement & Concrete

Mining

**Petroleum**  
Aircraft Fueling  
Dispensing  
Dock  
Transfer

Spray

Steam

Vacuum

LPG Delivery

**Water**  
Discharge  
Suction & Discharge  
Washdown

Welding

Coupling Systems

Equipment

Appendix

# Maxxim™ Premier



## Product Specifications

### Application

For Stage II Balance Systems where the gasoline vapors from the fill pipe are pushed back through the outer hose. The outer vapor hose has a textile-reinforced thermoplastic layer over a wire helix. The textile-reinforced thermoplastic cover has maximum puncture resistance, stable dimensions and long service life. The wire braid construction for the fuel hose provides excellent kink resistance and low computer creep. Maxxim™ Premier hose is C.A.R.B. and UL 330 approved.

### Construction Tube

Nitrile synthetic rubber (ORS)

### Cover

Chemivic™ synthetic rubber (ORS), thermoplastic outer with textile reinforcement and wire helix

### Reinforcement

Braided (1) steel wire

### Temperature Range

-40°F to 140°F (-40°C to 60°C)

### Packaging

Coupled lengths only, 6 pieces per box

### Branding

Not branded

### Couplings

Available only as factory coupled assembly.

### Order Codes

532-365-440

## Maxxim™ Premier

ID		ID-Inner Hose		Nom. OD-Inner Hose		Weight-Inner Hose	
in.	mm	in.	mm	psi	MPa	lb./ft.	kg/m
1¼	31.75	5/8	15.9	0.85	21.6	0.22	0.33

**Air & Multipurpose**

- General Purpose
- Heavy Duty
- Push-on

Chemical Transfer

Cleaning Equipment

- Food**
- Transfer
- Washdown

Marine

**Material Handling**

- Abrasives
- Bulk Transfer
- Cement & Concrete

Mining

**Petroleum**

- Aircraft Fueling
- Dispensing
- Dock Transfer

Spray

Steam

Vacuum

LPG Delivery

**Water**

- Discharge
- Suction & Discharge
- Washdown

Welding

Coupling Systems

Equipment

Appendix

# Maxxim™ Premier Plus

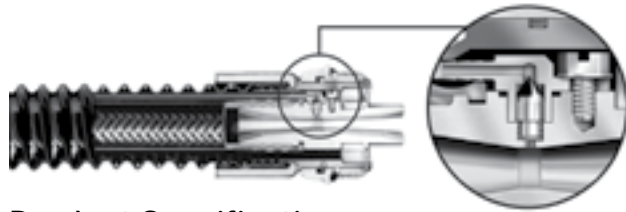

## Product Specifications

### Application

Maxxim™ Premier Plus incorporates a Venturi pump in the protected confines of the inner fuel hose coupling to keep the vapor path open in the outer hose. As gasoline flows through the Venturi pump, gasoline accumulating in the bottom loop of the vapor hose is collected and returned to the fuel hose. C.A.R.B., EVR and UL 330 approved.

### Construction Tube

Nitrile synthetic rubber (ORS)

### Cover

Chemivic™ synthetic rubber (ORS), thermoplastic outer with textile reinforcement and wire helix.

### Reinforcement

Braided (1) steel wire

### Temperature Range

-40°F to 140°F (-40°C to 60°C)

### Packaging

Coupled lengths only, 6 pieces per box

### Branding

Not branded

### Couplings

Available only as factory coupled assembly.

### Order Codes

532-365-441

532-365-641 (EVR)

## Maxxim™ Premier Plus

ID		ID-Inner Hose		Nom. OD-Inner Hose		Weight-Inner Hose	
in.	mm	in.	mm	psi	MPa	lb./ft.	kg/m
1 1/4	31.75	5/8	15.9	0.85	21.6	0.22	0.33

**Air & Multipurpose**  
General Purpose  
Heavy Duty  
Push-on

Chemical Transfer

Cleaning Equipment

**Food**  
Transfer  
Washdown

Marine

**Material Handling**  
Abrasives  
Bulk Transfer  
Cement & Concrete

Mining

**Petroleum**  
Aircraft Fueling  
Dispensing  
Dock  
Transfer

Spray

Steam

Vacuum

LPG Delivery

**Water**  
Discharge  
Suction & Discharge  
Washdown

Welding

Coupling Systems

Equipment

Appendix

# Pacer™



## Product Specifications

### Application

For all types of gasoline dispensing applications where flexibility and a lightweight hose is desired. Pacer™ is designed with a spiral textile reinforcement. UL 330 and CUL approved.

### Construction Tube

Nitrile synthetic rubber (ORS)

### Cover

Chemivic™ synthetic rubber (ORS)

### Reinforcement

Spiral synthetic yarn with static wire

### Temperature Range

-40°F to 140°F (-40°C to 60°C)

### Packaging

Reels or coupled lengths

### Branding

Example: 3/4" Pacer™ Continental ContiTech

### Couplings

Contact fitting manufacturer for proper fitting recommendation and coupling procedure.

### Order Codes

595-015 (bulk)

595-017 (factory coupled assemblies)

## Pacer™

ID		Nom. OD		Weight	
in.	mm	in.	mm	lb./ft.	kg/m
5/8	15.9	0.98	24.9	0.28	0.42
3/4	19.1	1.15	29.2	0.37	0.55
1	25.4	1.50	38.1	0.60	0.89

**Air & Multipurpose**

- General Purpose
- Heavy Duty
- Push-on

Chemical Transfer

Cleaning Equipment

**Food**

- Transfer
- Washdown

Marine

**Material Handling**

- Abrasives
- Bulk Transfer
- Cement & Concrete

Mining

**Petroleum**

- Aircraft Fueling
- Dispensing
- Dock Transfer

Spray

Steam

Vacuum

LPG Delivery

**Water**

- Discharge
- Suction & Discharge
- Washdown

Welding

Coupling Systems

Equipment

Appendix

# Aggie Gas™



## Product Specifications

### Application

A multi-use type hose for dispensing gasoline, grease, kerosene, and petroleum oils from farm and barrel type pumps. It is for agricultural, construction and industrial service where UL approval is not required.

### Construction Tube

Nitrile synthetic rubber (ORS)

### Cover

Black or red Chemivic™ synthetic rubber (ORS)

### Reinforcement

Spiral synthetic yarn

### Temperature Range

-30°F to 140°F (-34°C to 60°C)

### Packaging

Reels or coupled lengths, 5 pieces per box

### Branding

Example: Aggie Gas™ 3/4" (19.1mm) Static Bonded Continental ContiTech

### Couplings

Contact fitting manufacturer for proper fitting recommendation and coupling procedure.

### Aggie Gas™ - No Static Wire

Order Codes: 595-001 (no static wire) (black) 595-002 (no static wire) (red)

3/4" SAP: 20352464 (8'), 20352465 (10'), 20352504 (12'), 20352507 (14')

1" SAP: 20352551 (8'), 20352552 (10'), 20352535 (12')

ID		Nom. OD		Weight	
in.	mm	in.	mm	lb./ft.	kg/m
3/4	19.1	1.11	28.2	0.27	0.40
1	25.4	1.40	35.6	0.52	0.77

### Aggie Gas™ - With Static Wire

Order Codes: 595-026 (with static wire - bulk) (black) 595-028 (with static wire) - factory coupled assemblies) (black)

3/4" SAP: 20028755 (8'), 20028757 (10'), 20028759 (12'), 20028761 (14')

1" SAP: 20028755 (8'), 20028742 (10'), 20028744 (12'), 20028746 (14')

ID		Nom. OD		Weight	
in.	mm	in.	mm	lb./ft.	kg/m
3/4	19.1	1.11	28.2	0.27	0.40
1	25.4	1.40	35.6	0.52	0.77

**Air & Multipurpose**  
General Purpose  
Heavy Duty  
Push-on

Chemical Transfer

Cleaning Equipment

**Food**  
Transfer  
Washdown

Marine

**Material Handling**  
Abrasives  
Bulk Transfer  
Cement & Concrete

Mining

**Petroleum**  
Aircraft Fueling  
Dispensing  
Dock  
Transfer

Spray

Steam

Vacuum

LPG Delivery

**Water**  
Discharge  
Suction & Discharge  
Washdown

Welding

Coupling Systems

Equipment

Appendix

# BC Cold Flex



## Product Specifications

### Application

A premium gas pump hose for use in extremely cold environments. Remains flexible where temperatures of -65°F (-54°C) are encountered. UL 330 and CUL approved. The only UL approved cold temperature

### Construction Tube

Black, low-temp synthetic rubber

### Cover

Black, low-temp synthetic rubber (wrapped finish)

### Reinforcement

Braided synthetic yarn with antistatic wire

### Temperature Range

-65°F to 140°F (-54°C to 60°C)

### Packaging

500' reels +/- 50'; minimum 50'; maximum 3 pieces  
Premade assemblies available

### Branding

Example: Continental ContiTech 559 N, Made in U.S.A. 3/4" (19mm) UL, CUL Listed BC Cold Flex Gasoline Hose

### Couplings

Use Continental ContiTech Fuelgrip Fittings for proper fitting recommendation and coupling procedure.

### Order Codes

532-395

## BC Cold Flex

SAP #	ID		Nom. OD		Weight	
	in.	mm	in.	mm	lb./ft.	kg/m
20195843	3/4	19.1	1.13	28.7	0.32	0.48
20195844	1	25.4	1.50	38.1	0.57	0.85

**Air & Multipurpose**

- General Purpose
- Heavy Duty
- Push-on

Chemical Transfer

Cleaning Equipment

- Food Transfer
- Washdown

Marine

**Material Handling**

- Abrasives
- Bulk Transfer
- Cement & Concrete

Mining

**Petroleum**

- Aircraft Fueling
- Dispensing
- Dock Transfer

Spray

Steam

Vacuum

LPG Delivery

**Water**

- Discharge
- Suction & Discharge
- Washdown

Welding

Coupling Systems

Equipment

Appendix

# BC Gasoline



## Product Specifications

### Application

For all types of dispensing pump applications where flexibility and lightweight are desired. BC is available with one or two textile braids. UL 330 and CUL approved.

### Construction Tube

Nitrile synthetic rubber (ORS)

### Cover

Black Chemivic™ synthetic rubber (ORS)

### Reinforcement

Braided synthetic yarn with static wire, available in one or two braid

### Temperature Range

-40°F to 140°F (-40°C to 60°C)

### Packaging

5/8" and 3/4" - Reels or coupled lengths, 10 pieces per box  
 1" - Reels or coupled lengths, 5 pieces per box

### Branding

Example: 1" (25.4mm) 2BD. CUL, UL Listed style BC Gasoline Continental ContiTech 559N. Made in U.S.A.

### Couplings

Contact fitting manufacturer for proper fitting recommendation and coupling procedure.

### Order Codes

532-012 (1 braid)  
 532-013 (2 braid)  
 532-314 (Blue)  
 532-313 (Red)  
 532-309 (Green)

### BC Gasoline (1 Braid)

SAP #	ID		Nom. OD		Weight	
	in.	mm	in.	mm	lb./ft.	kg/m
20014734	5/8	15.9	1.00	25.4	0.28	0.42
20014738	3/4	19.1	1.13	28.7	0.32	0.48

### BC Gasoline (2 Braid)

SAP #	ID		Nom. OD		Weight	
	in.	mm	in.	mm	lb./ft.	kg/m
20021581	5/8	15.9	1.00	25.4	0.24	0.36
20021585	3/4	19.1	1.19	30.2	0.37	0.55
20021591	1	25.4	1.50	38.1	0.55	0.82

**Air & Multipurpose**  
 General Purpose  
 Heavy Duty  
 Push-on

Chemical Transfer

Cleaning Equipment

**Food**  
 Transfer  
 Washdown

Marine

**Material Handling**  
 Abrasives  
 Bulk Transfer  
 Cement & Concrete

Mining

**Petroleum**  
 Aircraft Fueling  
 Dispensing  
 Dock  
 Transfer

Spray

Steam

Vacuum

LPG Delivery

**Water**  
 Discharge  
 Suction & Discharge  
 Washdown

Welding

Coupling Systems

Equipment

Appendix

# BC Marina



## Product Specifications

### Application

For dispensing gasoline to pleasure craft and commercial boats at fresh and salt water marinas. UL 330 and CUL approved.

### Construction Tube

Nitrile synthetic rubber (ORS)

### Cover

Green Chemivic™ synthetic rubber (ORS) (nonmarking)

### Reinforcement

Braided (2) synthetic yarn with static wire

### Temperature Range

-40°F to 140°F (-40°C to 60°C)

### Packaging

Reels or coupled lengths

### Branding

Example: 1" (25.4mm) 2BD. UL Listed Marina Gasoline Continental ContiTech 559N. Made in U.S.A.

### Couplings

Contact fitting manufacturer for proper fitting recommendation and coupling procedure.

### Order Codes

532-293

## BC Marina

SAP#	ID		Nom. OD		Weight	
	in.	mm	in.	mm	lb./ft.	kg/m
20021819	3/4	19.1	1.19	30.2	0.38	0.57
20021826	1	25.4	1.50	38.1	0.57	0.85

**Air & Multipurpose**

- General Purpose
- Heavy Duty
- Push-on

Chemical Transfer

Cleaning Equipment

- Food Transfer
- Washdown

Marine

**Material Handling**

- Abrasives
- Bulk Transfer
- Cement & Concrete

Mining

**Petroleum**

- Aircraft Fueling
- Dispensing
- Dock Transfer

Spray

Steam

Vacuum

LPG Delivery

**Water**

- Discharge
- Suction & Discharge
- Washdown

Welding

Coupling Systems

Equipment

Appendix



# Flexsteel® Futura™ Ethan-ALL™ Dispensing Hose Assembly



## Product Specifications

### Application

Flexsteel® Futura™ Ethan-ALL™ dispensing hose assembly is UL certified for use in ethanol dispensing applications up to E85. This new assembly provides the quality Futurin™ cover with its superior ozone resistance along with a new premium layline. The tube construction meets the E25/E85 compatibility test requirements of UL 87A.

The Flexsteel® Futura™ Ethan-ALL™ dispensing hose assembly uses the Continental ContiTech proprietary Fuel Grip™ fitting with a premium nickel coating to ensure corrosion is limited.

### Construction Tube

Nitrile synthetic rubber

### Cover

Futurin™ synthetic rubber

### Reinforcement

Wire braid

### Temperature Range

-40°F to 140°F (-40°C to 60°C)

### Packaging

Coupled assemblies only

### Branding

Example: 3/4" (UL) Listed Continental ContiTech Flexsteel® Futura™ Ethan-ALL™ E85 559N. Made in U.S.A.

### Order Codes

532-337-124

## Flexsteel® Futura™ Ethan-ALL™ Dispensing Hose Assembly

ID		OD		Max. WP		Weight	
in.	mm	in.	mm	psi	MPa	lb./ft.	kg/m
3/4	19.1	1.13	28.7	50	0.34	0.46	0.69

Air & Multipurpose  
General Purpose  
Heavy Duty  
Push-on

Chemical Transfer

Cleaning Equipment

Food  
Transfer  
Washdown

Marine

Material Handling  
Abrasives  
Bulk Transfer  
Cement & Concrete

Mining

Petroleum  
Aircraft Fueling  
Dispensing  
Dock  
Transfer

Spray

Steam

Vacuum

LPG Delivery

Water  
Discharge  
Suction & Discharge  
Washdown

Welding

Coupling Systems

Equipment

Appendix

# DEF Dispensing Hose



## Product Specifications

### Application

Diesel Exhaust Fluid (DEF: aqueous 32.5% nitrogen solution of high-purity urea in deionized water) is a key component of selective catalytic reduction (SCR) systems, which help diesel vehicles meet stringent emission regulations effective January 1, 2010. DEF is a liquid reducing agent that reacts with engine exhaust in the presence of a catalyst to convert smog-forming nitrogen oxides (NOx) into harmless nitrogen and water vapor.

Continental ContiTech is specifically designed to convey the high-purity, aqueous urea solution DEF. Hose tube compound is specially formulated with low extraction EPDM and peroxide cured to provide superior extraction levels to significantly reduce contamination. Flexible softwall construction provides superior handling in standard dispensing and reeling applications. Static wire available for installation in Class I, Division 1 areas.

### Construction Tube

Specially formulated low-extraction EPDM, peroxide cured

### Cover

Specially formulated EPDM

### Reinforcement

Polyester braid

### Temperature Range

-40°F to 140°F (-40°C to 60°C)

### Packaging

Bulk, coupled assemblies (NPT and BSPP fittings available)

### Branding

Example: Continental ContiTech DEF Dispensing Hose 3/4" (19.1mm)

### Order Codes

532-027

Assemblies available

## DEF Dispensing Hose

Features	Benefits
Specially formulated low extraction EPDM compound for tube peroxide cured	Provides superior extraction levels to significantly reduce contamination that can clog an SCR system and stop a truck
Enhanced manufacturing practices	Significantly reduce contamination that can clog an SCR system and stop a truck
Premium braided construction	Reduced volumetric expansion to meet Weights and Measures system criteria
Static wire	Requirement for installations in Class I, Division 1 areas as outlined in NFPA 70
Meets ISO 22241 standard	Ensures desirable characteristics of AUS 32 (DEF) are met, such as quality, safety, reliability and contamination

## DEF Dispensing Hose

SAP #	ID	Nom. OD		Weight		Max WP		
		in.	mm	lb./ft.	kg/m	psi	MPa	
20552436	1/2	12.7	0.89	22.6	0.21	0.31	250	1.72
20528917	3/4	19.1	1.13	28.8	.30	0.46	250	1.72
20686517	1	25.4	1.45	36.8	0.42	0.62	250	1.72

Air & Multipurpose

General Purpose

Heavy Duty

Push-on

Chemical Transfer

Cleaning Equipment

Food

Transfer

Washdown

Marine

Material Handling

Abrasives

Bulk Transfer

Cement & Concrete

Mining

Petroleum

Aircraft Fueling

Dispensing

Dock

Transfer

Spray

Steam

Vacuum

LPG Delivery

Water

Discharge

Suction & Discharge

Washdown

Welding

Coupling Systems

Equipment

Appendix

# Dock



	Page	Nitrile Tube	Flosyn Tube	Max WP	Corrugated	Temp. Range	Built-in Nipple	Swage Nipple*
Flexdock 225	172	Yes	Yes	225	Yes	-25°F to 200°F (-32°C to 93°C)	Yes	Yes
Flexdock 300	173	Yes	Yes	300	Yes	-25°F to 200°F (-32°C to 93°C)	Yes	Yes
Hot Tar & Asphalt Rough Bore	181	Yes		200		-25°F to 350°F (-32°C to 177°C)	Yes	
Hot Tar & Asphalt Smooth Bore	181	Yes		200		-25°F to 350°F (-32°C to 177°C)	Yes	
Smooth Bore Dock 200	174	Yes	Yes	200		-25°F to 200°F (-32°C to 93°C)	Yes	Yes
Smooth Bore Dock 300	175	Yes	Yes	300		-25°F to 200°F (-32°C to 93°C)	Yes	Yes
Tanker Barge Discharge	176	Yes	Yes	200		-25°F to 220°F (-32°C to 105°C)	Yes	Yes
Oil Rig Service with Integral Positive Float System	182			290		-22°F to 180°F (-30°C to 82°C)		
Plicord HW Dry Cement/Barytes	178			150		-22°F to 180°F (-30°C to 82°C)		
Plicord SW Dry Cement/Barytes	179			150		-22°F to 180°F (-30°C to 82°C)		
RB Dock Asphalt & Bitumen EN 13482	184			225		-30°F to 392°F (-37°C to 200°C)	Yes	
SB Dock Asphalt & Bitumen EN 13482	185			225		-30°F to 392°F (-37°C to 200°C)	Yes	
Vapor Recovery Dock	177	Yes	Yes	25	Yes	-25°F to 200°F (-32°C to 93°C)	Yes	Yes

Up to 10" ID

**Air & Multipurpose**  
General Purpose  
Heavy Duty  
Push-on

Chemical Transfer

Cleaning Equipment

**Food**  
Transfer  
Washdown

Marine

**Material Handling**  
Abrasives  
Bulk Transfer  
Cement & Concrete

Mining

**Petroleum**  
Aircraft Fueling  
Dispensing  
Dock  
Transfer

Spray

Steam

Vacuum

LPG Delivery

**Water**  
Discharge  
Suction & Discharge  
Washdown

Welding

Coupling Systems

Equipment

Appendix

# Flexdock® 225



**Air & Multipurpose**

- General Purpose
- Heavy Duty
- Push-on

Chemical Transfer

Cleaning Equipment

**Food**

- Transfer
- Washdown

Marine

**Material Handling**

- Abrasives
- Bulk Transfer
- Cement & Concrete

Mining

**Petroleum**

- Aircraft Fueling
- Dispensing
- Dock Transfer

Spray

Steam

Vacuum

LPG Delivery

**Water**

- Discharge
- Suction & Discharge
- Washdown

Welding

Coupling Systems

Equipment

Appendix

## Product Specifications

**Application**

Built with a corrugated cover to provide flexibility in petroleum transfer service. A variety of tube compounds are available to tailor the chemical and hydrocarbon resistance of the hose to the type of material handled.

**Construction Tube**

Nitrile synthetic rubber for up to 50% aromatics. Also available with a Flosyn® tube for up to 100% aromatics.

**Cover**

Black Wingprene® synthetic cover, corrugated, wrapped finish

**Reinforcement**

Spiral-plied heavy-duty synthetic fabric with double wire helix

**Temperature Range**

-25°F to 200°F (-32°C to 93°C)

**Packaging**

Chloroplast heavy-duty packaging

**Branding (Spiral)**

Example: Continental ContiTech Flexdock® 225 psi WP Nitrile Oil Service

**Couplings**

Coupled with standard built-in steel nipple/150#RFSO flanges. Available in other bolt hole patterns, materials and floating flanges on request. Swage nipples are offered up to 10". Hose assembly is electrically continuous unless otherwise specified by customer.

**Non-Stock/Sizes**

Custom lengths available, contact Customer Service.

**Order Codes**

- 541-532 (Nitrile tube)
- 541-534 (Flosyn® tube)

### Flexdock™ 225

SAP #		ID		Nom. OD		Max. WP		Bend Radius		Vacuum HG		Weight	
Nitrile Tube	Flosyn Tube	in.	mm	in.	mm	psi	MPa	in.	mm	in.	mm	lb./ft.	kg/m
20346713	20424276	3	76.2	3.89	98.8	225	1.55	11	279	29	737	3.28	4.88
20655171	20054995	4	101.6	5.29	134.4	225	1.55	15	381	29	737	6.30	9.38
20032061	20054996	6	152.4	7.34	186.4	225	1.55	22	559	29	737	9.50	14.14
20476794	20129447	8	203.2	9.43	239.5	225	1.55	30	762	29	737	13.81	20.55
20098252	20139283	10	254.0	11.63	295.4	225	1.55	40	1016	29	737	20.49	30.49
20704428	20424277	12	304.8	13.72	348.5	225	1.55	60	1524	29	737	25.13	37.40

Note: Factory coupled hose manufactured according to the code of Federal Regulations Standard 33 CFR 154.500 and 33 CFR 156.170.

# Flexdock® 300



## Product Specifications

### Application

Built with a corrugated cover to provide flexibility in petroleum transfer service. A variety of tube compounds are available to tailor the chemical and hydrocarbon resistance of the hose to the type of material handled.

### Construction Tube

Nitrile synthetic rubber for up to 50% aromatics. Also available with a Flosyn® tube for up to 100% aromatics.

### Cover

Black Wingprene® synthetic cover, corrugated, wrapped finish

### Reinforcement

Heavy-duty synthetic fabric plies with double wire helix

### Temperature Range

-25°F to 200°F (-32°C to 93°C)

### Packaging

Chloroplast heavy-duty packaging

### Branding (Spiral)

Example: Continental ContiTech Flexdock® 300 psi WP Nitrile Oil Service

### Couplings

Coupled with standard built-in steel nipple/150#RF50 flanges. Available in other bolt hole patterns, materials and floating flanges on request. Swage nipples are offered up to 10". Hose assembly is electrically continuous unless otherwise specified by customer.

### Non-Stock/Sizes

Custom lengths available, contact Customer Service.

### Order Codes

541-533 (Nitrile Tube)  
541-535 (Flosyn® tube)

## Flexdock™ 300

SAP #		ID		Nom. OD		Max. WP		Bend Radius		Vacuum HG		Weight	
Nitrile Tube	Flosyn Tube	in.	mm	in.	mm	psi	MPa	in.	mm	in.	mm	lb./ft.	kg/m
20015736	20307537	4	101.6	5.29	134.4	300	2.07	19	483	29	737	6.30	9.38
20015748	20169212	6	152.4	7.35	186.7	300	2.07	28	711	29	737	9.64	14.35
20015764	20160411	8	203.2	9.63	244.6	300	2.07	38	965	29	737	15.56	23.16
20546829		10	254.0	11.51	292.4	300	2.07	48	1219	29	737	19.73	29.36
20015774	20590479	12	305.5	13.94	353.9	300	2.07	58	1473	29	737	28.89	42.98

Note: Factory coupled hose manufactured according to the code of Federal Regulations Standard 33 CFR 154.500 and 33 CFR 156.170.

**Air & Multipurpose**  
General Purpose  
Heavy Duty  
Push-on

Chemical Transfer

Cleaning Equipment

**Food**  
Transfer  
Washdown

Marine

**Material Handling**  
Abrasives  
Bulk Transfer  
Cement & Concrete

Mining

**Petroleum**  
Aircraft Fueling  
Dispensing  
Dock  
Transfer

Spray

Steam

Vacuum

LPG Delivery

**Water**  
Discharge  
Suction & Discharge  
Washdown

Welding

Coupling Systems

Equipment

Appendix

# Smooth Bore Dock 200



## Product Specifications

### Application

For the transfer of petroleum-based products between docks and ships under all types of service conditions. It is available in a number of tube compounds to tailor the fluid handling capabilities to a wide variety of petroleum and chemical compositions.

### Construction Tube

Nitrile synthetic rubber for up to 50% aromatics. Also available with a Flosyn® tube for up to 100% aromatics.

### Cover

Black Chemivic™ (smooth cover, wrap finish)

### Reinforcement

Spiral plied synthetic fabric with wire helix

### Temperature Range

-25°F to 200°F (-32°C to 93°C)

### Packaging

Chloroplast heavy-duty packaging

### Branding (Spiral)

Example: Continental ContiTech SB Dock oil service, 200 psi WP Nitrile

### Couplings

Coupled with standard built-in steel nipple/150#RFSO flanges. Available in other bolt hole patterns, materials and floating flanges on request. Swage nipples are offered up to 10". Hose assembly is electrically continuous unless otherwise specified by customer.

### Non-Stock/Sizes

Custom lengths available, contact Customer Service.

### Order Codes

541-004 (Nitrile Tube)  
541-586 (Flosyn® Tube)

## Smooth Bore Dock 200

SAP #	ID	Nom. OD		Max. WP		Bend Radius		Vacuum HG		Weight			
		Nitrile Tube	Flosyn Tube	in.	mm	psi	MPa	in.	mm	in.	mm	lb./ft.	kg/m
20014752	20248891	4	101.6	5.29	134.4	200	1.38	24	610	29	737	6.15	9.15
20014760	20170662	6	152.4	7.45	189.2	200	1.38	36	914	29	737	11.27	16.77
20014771	20015908	8	203.2	9.62	244.4	200	1.38	48	1219	29	737	16.44	24.46
20452847	20015912	10	254.0	11.62	295.2	200	1.38	60	1524	29	737	21.21	31.56
20014790		12	304.8	13.94	354.1	200	1.38	72	1829	29	737	30.63	45.58

Note: Factory coupled hose manufactured according to the code of Federal Regulations Standard 33 CFR 154.500 and 33 CFR 156.170.

Air & Multipurpose

General Purpose

Heavy Duty

Push-on

Chemical Transfer

Cleaning Equipment

Food

Transfer

Washdown

Marine

Material Handling

Abrasives

Bulk Transfer

Cement & Concrete

Mining

Petroleum

Aircraft Fueling

Dispensing

Dock

Transfer

Spray

Steam

Vacuum

LPG Delivery

Water

Discharge

Suction & Discharge

Washdown

Welding

Coupling Systems

Equipment

Appendix

# Smooth Bore Dock 300



## Product Specifications

### Application

For the transfer of petroleum-based products between docks and ships under all types of service conditions. It is available in a number of tube compounds to tailor the fluid handling capabilities to a wide variety of petroleum and chemical compositions.

### Construction Tube

Nitrile synthetic rubber for up to 50% aromatics. Also available with a Flosyn® tube for up to 100% aromatics.

### Cover

Black Wingprene® synthetic rubber

### Reinforcement

Spiral wire helix between plies of synthetic fabric

### Temperature Range

-25°F to 200°F (-32°C to 93°C)

### Packaging

Chloroplast heavy-duty packaging

### Branding (Spiral)

Example: Continental ContiTech SB Dock oil service, 300 psi WP Nitrile

### Couplings

Coupled with standard built-in steel nipple/150#RF50 flanges. Available in other bolt hole patterns, materials and floating flanges on request. Swage nipples are offered up to 10". Hose assembly is electrically continuous unless otherwise specified by customer.

### Non-Stock/Sizes

Custom lengths available, contact Customer Service.

### Order Codes

541-580 (Nitrile Tube)  
541-584 (Flosyn® Tube)

## Smooth Bore Dock 300

SAP #		ID		Nom. OD		Max. WP		Bend Radius		Vacuum HG		Weight	
Nitrile Tube	Flosyn Tube	in.	mm	in.	mm	psi	MPa	in.	mm	in.	mm	lb./ft.	kg/m
20274024	20170523	4	101.6	5.29	134.4	300	2.07	27	686	29	737	6.15	9.15
20266243	20015899	8	203.2	9.78	248.4	300	2.07	51	1295	29	737	17.93	26.68
20406529		10	254.0	11.77	299.0	300	2.07	63	1600	29	737	22.99	34.21
20704654		12	304.8	14.15	359.4	300	2.07	75	1905	29	737	33.29	49.54

Note: Factory coupled hose manufactured according to the code of Federal Regulations Standard 33 CFR 154.500 and 33 CFR 156.170.

**Air & Multipurpose**  
General Purpose  
Heavy Duty  
Push-on

Chemical Transfer

Cleaning Equipment

**Food**  
Transfer  
Washdown

Marine

**Material Handling**  
Abrasives  
Bulk Transfer  
Cement & Concrete

Mining

**Petroleum**  
Aircraft Fueling  
Dispensing  
Dock  
Transfer

Spray

Steam

Vacuum

LPG Delivery

**Water**  
Discharge  
Suction & Discharge  
Washdown

Welding

Coupling Systems

Equipment

Appendix

# Tanker Barge Discharge



## Product Specifications

### Application

For discharge applications such as the transfer of petroleum-based products between docks and barges.

### Construction Tube

Nitrile synthetic rubber for up to 50% aromatics

### Cover

Black Wingprene® synthetic rubber

### Reinforcement

Spiral-plied synthetic fabric with grounding wires

### Temperature Range

-25°F to 220°F (-32°C to 104°C)

### Packaging

Chloroplast heavy-duty packaging

### Branding (Spiral)

Example: Continental ContiTech Tanker Barge Discharge, 200 psi WP Nitrile

### Couplings

Coupled with standard built-in steel nipple/150#RFSO flanges. Available in other bolt hole patterns, materials and floating flanges on request. Swage nipples are offered up to 10". Hose assembly is electrically continuous unless otherwise specified by customer.

### Non-Stock/Sizes

Custom lengths available, contact Customer Service.

### Order Codes

541-426 (Nitrile tube)

## Tanker Barge Discharge

SAP #	ID	Nom. OD		Max. WP		Weight		
		in.	mm	in.	mm	lb./ft.	kg/m	
20045864	4	101.6	5.09	129.3	200	1.38	4.30	6.40
20104917	6	152.4	7.08	179.8	200	1.38	6.18	9.20
20136624	8	203.2	9.08	230.6	200	1.38	8.06	11.99
20015537	10	254.0	11.06	280.9	200	1.38	9.93	14.78
20259811	12	304.8	13.28	337.3	200	1.38	13.91	20.70

Note: Factory coupled hose manufactured according to the code of Federal Regulations Standard 33 CFR 154.500 and 33 CFR 156.170.

Air & Multipurpose

General Purpose

Heavy Duty

Push-on

Chemical Transfer

Cleaning Equipment

Food

Transfer

Washdown

Marine

Material Handling

Abrasives

Bulk Transfer

Cement & Concrete

Mining

Petroleum

Aircraft Fueling

Dispensing

Dock

Transfer

Spray

Steam

Vacuum

LPG Delivery

Water

Discharge

Suction & Discharge

Washdown

Welding

Coupling Systems

Equipment

Appendix



# Vapor Recovery Dock



## Product Specifications

### Application

For use in the recovery of petroleum vapors during the transfer of petroleum-based products between docks and tankers or barges.

### Construction Tube

Nitrile synthetic rubber for up to 50% aromatics. Also available with a Flosyn® tube for up to 100% aromatics.

### Cover

Black Chemivic™ synthetic rubber (corrugated)

### Reinforcement

Synthetic fabric plies plus two (2) wire helix

### Temperature Range

-25°F to 200°F (-32°C to 93°C)

### Packaging

Chloroplast heavy-duty packaging

### Branding (Spiral)

Example: Continental ContiTech Vapor Recovery 25 psi MWP

### Couplings

Built-in nipples (or swaged fittings up to 10" ID) fitted with 150# flange with extra 5/8" diameter hole located midway between flange bolt hole as per Coast Guard requirements.

### Non-Stock/Sizes

Custom lengths available, contact Customer Service.

### Order Codes

541-090 (Nitrile Tube)

541-643 (Flosyn® Tube)

## Vapor Recovery Dock

SAP #	ID		Nom. OD		Max. WP		Bend Radius		Vacuum HG		Weight			
	Nitrile Tube	Flosyn Tube	in.	mm	in.	mm	psi	MPa	in.	mm	in.	mm	lb./ft.	kg/m
	20585185		6	152.4	6.86	174.2	25	0.17	22	559	29	737	5.70	8.48
20157291		8	203.2	8.89	225.8	25	0.17	30	762	29	737	8.26	12.29	
20323233		10	254.0	10.97	278.6	25	0.17	40	1016	29	737	12.63	18.80	
20014974		12	304.8	13.00	330.2	25	0.17	60	1524	29	737	15.07	22.43	

Note: Factory coupled hose manufactured according to the code of Federal Regulations Standard 33 CFR 154.500 and 33 CFR 156.170.

**Air & Multipurpose**  
General Purpose  
Heavy Duty  
Push-on

Chemical Transfer

Cleaning Equipment

**Food**  
Transfer  
Washdown

Marine

**Material Handling**  
Abrasives  
Bulk Transfer  
Cement & Concrete

Mining

**Petroleum**  
Aircraft Fueling  
Dispensing  
Dock  
Transfer

Spray

Steam

Vacuum

LPG Delivery

**Water**  
Discharge  
Suction & Discharge  
Washdown

Welding

Coupling Systems

Equipment

Appendix

# Plicord® HW Dry Cement/Barytes



## Product Specifications

### Application

Heavy duty high performance suction and discharge hose for the bulk transfer of dry cement and barytes from supply vessels to off-shore platform and drilling rigs.

### Construction Tube

Black, ChemiTuf® static conducting synthetic rubber

### Cover

Black, SBR synthetic rubber with Yellow spiral stripe (Cement) and Orange stripe (Batytes) wrapped finish.

### Reinforcement

Spiral-plied (4) synthetic fabric plus helix wire

### Temperature Range

-32°F to 82°F (-25°C to 180°C)

### Packaging

30.5m coils (available in other lengths up to 122m)

### Branding (Spiral)

Example: Continental ContiTech Dry Cement Hardwall  
Continental ContiTech Barytes Hardwall

### Order Codes

549-275 (Cement)  
549-070 (Barytes)

## Plicord® HW Dry Cement/Barytes

ID	Nom. OD		Max. WP		Bend Radius	Weight		
	in.	mm	psi	bar		lb./ft.	kg/m	
4	102.3	4.84	121.0	150	10	1015	3.16	4.70
5	127.4	5.86	151.0	150	10	1270	5.41	8.04
6	152.6	6.85	176.4	150	10	1525	6.57	9.77

Hose safety factor (burst pressure) 4:1.

**Air & Multipurpose**

- General Purpose
- Heavy Duty
- Push-on

Chemical Transfer

Cleaning Equipment

- Food Transfer
- Washdown

Marine

**Material Handling**

- Abrasives
- Bulk Transfer
- Cement & Concrete

Mining

**Petroleum**

- Aircraft Fueling
- Dispensing
- Dock Transfer

Spray

Steam

Vacuum

LPG Delivery

**Water**

- Discharge
- Suction & Discharge
- Washdown

Welding

Coupling Systems

Equipment

Appendix

# Plicord® SW Dry Cement/Barytes



## Product Specifications

### Application

Heavy duty high performance discharge hose for the bulk transfer of dry cement and barites from supply vessels to off-shore platforms and drilling rigs.

### Construction Tube

Black ChemiTuf static dissipation

### Cover

Black SBR

### Reinforcement

4 plies with static wire

### Temperature Range

-32°F to 82°F (-25°C to 180°C)

### Packaging

30.5m coils (available in other lengths up to max 122m)

### Branding (Spiral)

Dry Cement Softwall by Continental ContiTech

Barytes Softwall by Continental ContiTech

### Order Codes

549-274 (Cement)

549-278 (Barytes)

## Plicord® SW Dry Cement/Barytes

ID		Nom. OD		Max. WP	Weight
in.	mm	in.	mm	psi	lb./ft.
3	76.0	3.83	97.4	150	2.44
4	101.6	4.85	123.2	150	3.22
5	127.0	5.88	149.4	150	4.13
6	152.4	6.93	176.0	150	5.24

Hose safety factor (burst pressure) 4:1.

**Air & Multipurpose**  
General Purpose  
Heavy Duty  
Push-on

Chemical Transfer

Cleaning Equipment

**Food**  
Transfer  
Washdown

Marine

**Material Handling**  
Abrasives  
Bulk Transfer  
Cement & Concrete

Mining

**Petroleum**  
Aircraft Fueling  
Dispensing  
Dock  
Transfer

Spray

Steam

Vacuum

LPG Delivery

**Water**  
Discharge  
Suction & Discharge  
Washdown

Welding

Coupling Systems

Equipment

Appendix

# Plicord® Dock Hose



## Product Specifications

### Application

For the transfer of petroleum products between docks and tankers and is rated for 250 working psi. Not intended for offshore or submarine applications.

### Branding (Impression)

Example: Continental ContiTech SB Submarine oil service, Nitrile 225 psi WP

### Construction Tube

Nitrile synthetic rubber

### Couplings

Coupled with galvanized built-in steel nipple/150#RFSSO flanges. Available in other bolt hole patterns, materials and floating flanges on request. Hose assembly is electrically continuous unless otherwise specified by customer.

### Cover

1/4" Black SBR synthetic rubber

### Non-Stock/Sizes

Custom lengths available, contact Customer Service.

### Reinforcement

Spiral wire helix between plies of synthetic fabric

### Order Codes

541-577

### Temperature Range

-25°F to 180°F (-32°C to 82°C)

### Packaging

Heavy-duty plastic packaging

## Plicord® Dock Hose

SAP #	ID		Nom. OD		Max. WP		Bend Radius		Weight		
	Black	in.	mm	in.	mm	psi	MPa	in.	mm	lb./ft.	kg/m
20015841	6		152.4	7.81	198.4	250	1.72	36	914	14.30	21.28
20108741	8		203.2	9.89	251.2	250	1.72	48	1219	20.05	29.84
20161600	10		254.0	12.07	306.6	250	1.72	60	1524	27.23	40.52
20264034	12		304.8	14.10	358.1	250	1.72	72	1829	31.93	47.52

Note: Factory coupled hose manufactured according to the code of Federal Regulations Standard 33 CFR 154.500 and 33 CFR 156.170.

Air & Multipurpose

General Purpose

Heavy Duty

Push-on

Chemical Transfer

Cleaning Equipment

Food

Transfer

Washdown

Marine

Material Handling

Abrasives

Bulk Transfer

Cement & Concrete

Mining

Petroleum

Aircraft Fueling

Dispensing

Dock

Transfer

Spray

Steam

Vacuum

LPG Delivery

Water

Discharge

Suction & Discharge

Washdown

Welding

Coupling Systems

Equipment

Appendix

# Hot Tar & Asphalt



## Product Specifications

### Application

Designed for petroleum-based products up to 350°F between docks and tankers or barges under heavy-duty conditions.

### Construction Tube

Nitrile synthetic rubber, flat steel wire helix supporting the tube

### Cover

Wingprene® synthetic rubber

### Reinforcement

Spiral-plied synthetic fabric with wire helix

### Temperature Range

-25°F to 350°F (-32°C to 177°C)

### Smooth Bore

Order Codes: 541-606

SAP #	ID		Nom. OD		Max. WP		Bend Radius		Vacuum HG		Weight	
	in.	mm	in.	mm	psi	MPa	in.	mm	in.	mm	lb./ft.	kg/m
20274024	4	101.6	5.28	134.1	225	1.55	36	914	29	737	6.48	9.64
20276576	6	152.4	7.72	196.1	225	1.55	48	1219	29	737	13.83	20.58
20266243	8	203.2	9.80	248.9	225	1.55	60	1524	29	737	19.11	28.44
20473949	10	254.0	11.80	299.7	225	1.55	80	2032	29	737	23.20	34.52

### Rough Bore

Order Codes: 541-582

SAP #	ID		Nom. OD		Max. WP		Bend Radius		Vacuum HG		Weight	
	in.	mm	in.	mm	psi	MPa	in.	mm	in.	mm	lb./ft.	kg/m
20283225	6	152.4	8.19	208.0	225	1.55	36	914	29	737	16.19	24.09
20288374	8	203.2	10.25	260.4	225	1.55	48	1219	29	737	22.39	33.32
20015897	10	254.0	12.31	312.7	225	1.55	60	1524	29	737	29.09	43.29

### Packaging

Custom lengths available, contact Customer Service.

### Branding

Example: Continental ContiTech RB Dock hot asphalt, 350°F, 225 psi max

### Couplings

Coupled with built-in steel nipple/150#RFSO flanges. Available in other bolt hole patterns, materials and floating flanges on request. Smooth bore assembly is electrically continuous unless otherwise specified by customer. Rough bore assembly is offered as electrically continuous only.

### Non-Stock/Sizes

Custom lengths available, contact Customer Service.

Air & Multipurpose  
General Purpose  
Heavy Duty  
Push-on

Chemical Transfer

Cleaning Equipment

Food  
Transfer  
Washdown

Marine

Material Handling  
Abrasives  
Bulk Transfer  
Cement & Concrete

Mining

Petroleum  
Aircraft Fueling  
Dispensing  
Dock  
Transfer

Spray

Steam

Vacuum

LPG Delivery

Water  
Discharge  
Suction & Discharge  
Washdown

Welding

Coupling Systems

Equipment

Appendix

# Oil Rig Service Hose with Integral Positive Float System



## Product Specifications

### Application

Hose specifically designed to be used on service vessels to offshore drilling and production platforms for the transfer of a wide range of products from petroleum to drinking water. The unique positive float system allows the hose to maintain flotation with products of various specific gravities.

The system consists of a section of floating hose up to a length of 30.5m which may be attached to various lengths of hose (up to 120m) attached to the supply vessel. In addition the supply hose may incorporate intergrated wear strips on the cover to improve the abrasion resistance of the hose. The system may be stored on platform reeling systems and the hoses may be supplied with a RFID chip for intergrated hose management.

### Construction Tube

Various synthetic rubber compounds are offered depending on hose service and product conveyed

### Cover

Synthetic rubber with excellent resistance to ozone and weathering. An abrasion strip is available to extend the service life of the outer hose

### Reinforcement

Spiral reinforcement plies available with (Hardwall) or without (Softwall) helix wire

### Positive float

Well proven closed cell foam floating material used also in OCIMF hoses. Foam thickness design based upon product conveyed as specified by the customer. The foam is covered with an integral orange rubber cover.

### Approvals

Currently in use in the North Sea with major oil and drilling companies.

### Branding

Standard ContiTech brand

### Temperature

-22°F to 180°F (-30°C to 82°C)

### Lengths

Custom built, up to 30.5m (100ft) with floatation and 120m (400ft.) without

### Colors

Available in orange or black

### Couplings

A range of internally and external swaged fittings and "built in" fittings are available for these hoses

### Packaging

Bulk and coupled assemblies available

### Dimensions

See below. Other diameter/design available upon request.

Air & Multipurpose

General Purpose

Heavy Duty

Push-on

Chemical Transfer

Cleaning Equipment

Food

Transfer

Washdown

Marine

Material Handling

Abrasives

Bulk Transfer

Cement & Concrete

Mining

Petroleum

Aircraft Fueling

Dispensing

Dock

Transfer

Spray

Steam

Vacuum

LPG Delivery

Water

Discharge

Suction & Discharge

Washdown

Welding

Coupling Systems

Equipment

Appendix

**3" Positive Float**

ID	Max. WP						Max SG*
	in.	mm	mm	psi	bar	mm	
2	51	220	290	20	510	8.35	8.00
3	76	240	290	20	760	9.90	4.20
4	102	270	290	20	1020	11.63	3.10

**1½" Positive Float**

ID	Max. WP						Max SG*
	in.	mm	mm	psi	bar	mm	
2	51	140	290	20	510	3.5	3.10
3	76	160	290	20	760	4.39	1.90
4	102	190	290	20	1020	5.37	1.60

Hose safety factor (burst pressure) 3:1. \*Floating hose OD's are based on 3" and 1½" floatation material and Rig Supply Softwall Hose

\*For vacuum service Rig Supply Hardwall is utilised \*Max SG - Maximum Specific Gravity of the product allowed to have a Reserved Buoyancy of Min +25%

**Air & Multipurpose**  
General Purpose  
Heavy Duty  
Push-on

Chemical Transfer

Cleaning Equipment

**Food**  
Transfer  
Washdown

Marine

**Material Handling**  
Abrasives  
Bulk Transfer  
Cement & Concrete

Mining

**Petroleum**  
Aircraft Fueling  
Dispensing  
Dock  
Transfer

Spray

Steam

Vacuum

LPG Delivery

**Water**  
Discharge  
Suction & Discharge  
Washdown

Welding

Coupling Systems

Equipment

Appendix

# RB Dock Asphalt & Bitumen EN 13482



## Product Specifications

### Application

Rough Bore (RB) Dock hose, designed for asphalt and bitumen products up to 200°C (392°F) dockside transfer between docks and ships, all sizes rated at full vacuum.

### Construction Tube

Black, oil resistant Chemigum® (Nitrile) synthetic rubber, supported by a flat steel helix wire

### Cover

Black, ozone, oil, sea water and abrasion resistant Nitrilesynthetic rubber

### Reinforcement

Spiral wire helix between plies of synthetic fabric

### Temperature Range

-37°F to 200°F (-30°C to 392°C)

### Branding (Spiral)

Coast Guard & Stainless steel name plate at both ends:  
Example: Continental ContiTech Asphalt and Bitumen EN 13482:2001 Type 2, RB, ID mm, 15 bar, 200°C

### Couplings

Built-in couplings with flanges supplies to customer requirements

### Standards

ISO 1307  
BS EN 13482 Type 2, Class B  
Coast Guard Federal Regulations, Title 33, Chapter 1, Subpart C clause 154.500

### Product Code

Built to length. Please contact our marketing department for further details.

## RB Dock Asphalt & Bitumen EN 13482

ID	Nom OD		Max. WP		Bend Radius	Weight
	in.	mm	bar	MPa		
6	152.4	208.0	15	225	1015	19790
8	203.2	253.2	15	225	1270	27680
10	254.0	304.8	15	225	1525	33630

Hose safety factor (burst pressure) 6:1. Vacuum resistance up to -0.9 bar.

**Air & Multipurpose**

- General Purpose
- Heavy Duty
- Push-on

Chemical Transfer

Cleaning Equipment

**Food**

- Transfer
- Washdown

Marine

**Material Handling**

- Abrasives
- Bulk Transfer
- Cement & Concrete

Mining

**Petroleum**

- Aircraft Fueling
- Dispensing
- Dock Transfer

Spray

Steam

Vacuum

LPG Delivery

**Water**

- Discharge
- Suction & Discharge
- Washdown

Welding

Coupling Systems

Equipment

Appendix



# SB Dock Asphalt & Bitumen EN 13482



## Product Specifications

### Application

Rough Bore (RB) Dock hose, designed for asphalt and bitumen products up to 200°C (392°F) dockside transfer between docks and ships, all sizes rated at full vacuum.

### Construction Tube

Black, oil resistant Chemigum® (Nitrile) synthetic rubber, supported by a flat steel helix wire

### Cover

Black, ozone, oil, sea water and abrasion resistant Nitrilesynthetic rubber

### Reinforcement

Spiral wire helix between plies of synthetic fabric

### Temperature Range

-37°F to 200°F (-30°C to 392°C)

### Branding (Spiral)

Coast Guard & Stainless steel name plate at both ends:  
Example: Continental ContiTech Asphalt and Bitumen EN 13482:2001 Type 2, RB, ID mm, 15 bar, 200°C

### Couplings

Built-in couplings with flanges supplies to customer requirements

### Standards

ISO 1307  
BS EN 13482 Type 2, Class B  
Coast Guard Federal Regulations, Title 33, Chapter 1, Subpart C clause 154.500

### Product Code

Built to length. Please contact our marketing department for further details.

### Order Code

541-240

## RB Dock Asphalt & Bitumen EN 13482

ID		Nom OD		Max. WP		Bend Radius	Weight
in.	mm	mm	bar	MPa	mm	g/m	
4	101.6	134.9	15	225	605	9520	
6	152.4	208.0	15	225	825	19790	
8	203.2	253.2	15	225	1120	27680	
10	254.0	304.8	15	225	1395	33630	

Hose safety factor (burst pressure) 6:1. Vacuum resistance up to -0.9 bar.

**Air & Multipurpose**  
General Purpose  
Heavy Duty  
Push-on

Chemical Transfer

Cleaning Equipment

**Food**  
Transfer  
Washdown

Marine

**Material Handling**  
Abrasives  
Bulk Transfer  
Cement & Concrete

Mining

**Petroleum**  
Aircraft Fueling  
Dispensing  
Dock  
Transfer

Spray

Steam

Vacuum

LPG Delivery

**Water**  
Discharge  
Suction & Discharge  
Washdown

Welding

Coupling Systems

Equipment

Appendix

# Transfer



**Air & Multipurpose**  
 General Purpose  
 Heavy Duty  
 Push-on

Chemical Transfer

Cleaning Equipment

**Food**  
 Transfer  
 Washdown

Marine

**Material Handling**  
 Abrasives  
 Bulk Transfer  
 Cement & Concrete

Mining

**Petroleum**  
 Aircraft Fueling  
 Dispensing  
 Dock  
 Transfer

Spray

Steam

Vacuum

LPG Delivery

**Water**  
 Discharge  
 Suction & Discharge  
 Washdown

Welding

Coupling Systems

Equipment

Appendix

	Page	Temp. Range	Refined Fuels	Corrugated Cover	Lightweight
Arctic ExtremeFlex	189	-65°F to 180°F (-54°C to 82°C)	Yes	Yes	Yes
Flexwing VersaFuel	190	-30°F to 180°F (-35°C to 82°C)	Yes		
Infinity Fuel Drop Hose	191	-40°F to 160°F (-40°C to 71°C)	Yes	Yes	Yes
Infinity HD Fuel Drop Hose	192	-40°F to 160°F (-40°C to 71°C)	Yes	Yes	Yes
Blue Low Temp Fuel Oil Delivery	187	-40°F to 140°F (-40°C to 60°C)	Yes		
LW Arctic Tank Truck	201	-65°F to 180°F (-54°C to 82°C)		Yes	Yes
Paladin	194	-40°F to 160°F (-40°C to 71°C)	Yes	Yes	Yes
Plicord Arctic Flexwing	202	-65°F to 180°F (-54°C to 82°C)	Yes		
Plicord ExtremeFlex	204	-40°F to 200°F (-40°C to 93°C)	Yes	Yes	Yes
Plicord Flexwing Petroleum	193	-35°F to 200°F (-37°C to 93°C)	Yes		
Plicord Fuel Discharge	203	-35°F to 180°F (-37°C to 82°C)	Yes		
Plicord LW Black Flextra II	198	-40°F to 180°F (-40°C to 82°C)	Yes	Yes	Yes
Plicord Oilfield Frac	197	-25°F to 180°F (-32°C to 82°C)			
Plicord Super Black Flexwing	196	-35°F to 200°F (-37°C to 93°C)	Yes		
Pyroflex Hot Tar & Asphalt II	206	-25°F to 350°F (-32°C to 177°C)			
Pyroflex Hot Tar Wand	207	-25°F to 350°F (-32°C to 177°C)			
Prospector for Oilfield 150	199	-25°F to 180°F (-32°C to 82°C)			
Prospector for Oilfield 300	200	-35°F to 180°F (-37°C to 82°C)			
Redwing Fuel Oil	188	-40°F to 140°F (-40°C to 60°C)	Yes		
Spiraflex Polyurethane Vapor Recovery	205	-30°F to 150°F (-35°C to 66°C)		Yes	Yes

# Blue Low Temp Fuel Oil Delivery



## Product Specifications

### Application

The new and improved Low Temperature Fuel Oil Delivery Hose is for transfer and delivery of fuel oil and petroleum products for home delivery, commercial, and industrial service designed to remain flexible in cold temperatures and provide superior oil resistance. The braided construction reduces kinking and twisting when reeling. The smooth cover has low drag resistance.

### Construction Tube

Nitrile (ORS)

### Cover

Blue Chemivic® Synthetic Rubber (ORS) (Smooth Finish)

### Reinforcement

Two Braid Textile with Static Wire

### Temperature Range

-40° F to 140° F (-40° C to 60° C)

### Packaging

Cut Lengths

### Branding (Spiral)

Example: 1¼" (31.75) Continental ContiTech Low Temp Fuel Oil A/S. Made in U.S.A.

### Order Codes

532-021

## Blue Low Temp Fuel Oil Delivery

SAP #	Color	ID/in.	ID/mm	Length	Stocked	psi	Weight	Product Code
20054898	Blue	1¼	31.75	100'	YES	250	.65 / FT	53202104010000
20031895	Blue	1¼	31.75	125'	YES	250	.65 / FT	53202104012500
20031896	Blue	1¼	31.75	150'	YES	250	.65 / FT	53202104015000
20054428	Blue	1¼	31.75	175'	N/S	250	.65 / FT	53202104017500
20031897	Blue	1⅜	34.92	125'	YES	250	.70 / FT	53202104412500
20031898	Blue	1⅜	34.92	150'	YES	250	.70 / FT	53202104415000
20145510	Blue	1⅜	34.92	175'	N/S	250	.70 / FT	53202104417500
20750636	Blue	1½	38.10	100'	2500'	250	.92 / FT	53202104810000
20046244	Blue	1½	38.10	125'	2500'	250	.92 / FT	53202104812500
20031899	Blue	1½	38.10	150'	2500'	250	.92 / FT	53202104815000
20750635	Blue	1½	38.10	175'	2500'	250	.92 / FT	53202104817500

**Air & Multipurpose**  
General Purpose  
Heavy Duty  
Push-on

Chemical Transfer

Cleaning Equipment

**Food**  
Transfer  
Washdown

Marine

**Material Handling**  
Abrasives  
Bulk Transfer  
Cement & Concrete

Mining

**Petroleum**  
Aircraft Fueling  
Dispensing  
Dock  
Transfer

Spray

Steam

Vacuum

LPG Delivery

**Water**  
Discharge  
Suction & Discharge  
Washdown

Welding

Coupling Systems

Equipment

Appendix

# Redwing® Fuel Oil



## Product Specifications

### Application

Redwing® Fuel Oil is for transfer and delivery of fuel oil and petroleum products for home delivery, commercial and industrial service. Redwing Fuel Oil has two textile braids. The braided construction reduces kinking and twisting when reeling. The smooth cover has low drag resistance.

### Construction Tube

Nitrile synthetic rubber (ORS)

### Cover

Red Chemivic™ synthetic rubber (smooth finish) (ORS)

### Reinforcement

Braided (2) synthetic yarn

### Temperature Range

-40°F to 140°F (-40°C to 60°C)

### Packaging

Reels, cut lengths, and coupled lengths

### Branding

Example: 1" (25.4mm) 2 BD Redwing® Fuel Oil Continental ContiTech Made in U.S.A.

### Couplings

Contact fitting manufacturer for proper fitting recommendation and coupling procedure.

### Order Codes

532-016

## Redwing® Fuel Oil

SAP #	ID		Nom. OD		Max. WP		Weight	
	in.	mm	in.	mm	psi	MPa	lb./ft.	kg/m
20021667	1	25.4	1.50	38.1	250	1.72	0.57	0.85
20021681	1¼	31.8	1.80	45.7	250	1.72	0.65	0.97
20021708	1¾	34.9	1.88	47.8	250	1.72	0.70	1.04
20021735	1½	38.1	2.10	53.3	150	1.03	0.92	1.37

Air & Multipurpose

General Purpose

Heavy Duty

Push-on

Chemical Transfer

Cleaning Equipment

Food

Transfer

Washdown

Marine

Material Handling

Abrasives

Bulk Transfer

Cement & Concrete

Mining

Petroleum

Aircraft Fueling

Dispensing

Dock

Transfer

Spray

Steam

Vacuum

LPG Delivery

Water

Discharge

Suction & Discharge

Washdown

Welding

Coupling Systems

Equipment

Appendix

# Arctic ExtremeFlex™

## A New Degree of Flexibility



### Product Specifications

#### Application

An extremely flexible and lightweight drop hose for transfer of petroleum-based products under suction, low-pressure discharge or gravity flow. Flexibility maintained down to -65°F (-54°C).

#### Construction Tube

Black Nitrile, RMA Class A (High Oil Resistance)

#### Cover

Corrugated Black Wingprene® synthetic rubber (wrapped impression), blue spiral stripe  
 Corrugated Blue Wingprene® synthetic rubber (wrapped impression), red spiral stripe

#### Reinforcement

Spiral-plied synthetic fabric with double wire helix

#### Temperature Range

-65°F to 180°F (-54°C to 82°C)

#### Packaging

Coiled and polywrapped

#### Branding (Spiral)

Example: Continental ContiTech Plicord® Arctic ExtremeFlex™ Petroleum Transfer 150 psi WP

#### Couplings

Use Continental ContiTech Insta-Lock™ Cam & Groove Fittings

#### Non-Stock/Sizes

400' minimum order

#### Non-Stock/Sizes

543-807 (black)  
 543-451 (blue)

### Arctic ExtremeFlex™

SAP #		ID		Nom. OD		Max. WP		Bend Radius		Vacuum HG		Weight	
Black	Blue	in.	mm	in.	mm	psi	MPa	in.	mm	in.	mm	lb./ft.	kg/m
20476228	20484433	2	51	2.5	63.5	150	1.03	2	51	29	737	1.08	1.61
20476229	20484435	3	76	3.48	88.5	150	1.03	3	76	29	737	1.62	2.41
20476250	20484436	4	102	4.55	115.7	150	1.03	4	102	29	737	2.35	3.50



Air & Multipurpose  
 General Purpose  
 Heavy Duty  
 Push-on

Chemical Transfer

Cleaning Equipment

Food  
 Transfer  
 Washdown

Marine

Material Handling  
 Abrasives  
 Bulk Transfer  
 Cement & Concrete

Mining

Petroleum  
 Aircraft Fueling  
 Dispensing  
 Dock  
 Transfer

Spray

Steam

Vacuum

LPG Delivery

Water  
 Discharge  
 Suction & Discharge  
 Washdown

Welding

Coupling Systems

Equipment

Appendix

# Flexwing VersaFuel™



## Product Specifications

### Application

For use in tank truck and in-plant operation to transfer diesel, biodiesel blends, B-100, ethanol blends, gasoline, oil and petroleum base products up to 60% aromatic content.

### Construction Tube

Synthetic rubber (static dissipating)

### Cover

Black synthetic rubber with excellent resistance to biodiesel, ethanol, oil/petroleum products and abrasion.

### Reinforcement

Spiral-plied synthetic fabric with helix wire

### Temperature Range

-30°F to 180°F (-34°C to 82°C)

### Packaging

100' lengths, coiled and polywrapped.

### Branding (Spiral)

Example: Continental ContiTech Flexwing VersaFuel™ 150 psi WP

### Couplings

Use Continental ContiTech Insta-Lock™ Cam and Groove fittings with this product.

### Non-Stock/Sizes

400' minimum order

### Order Codes

543-422

## Flexwing VersaFuel

SAP #	ID	Nom. OD		Max. WP		Bend Radius		Vacuum HG		Weight		
		in.	mm	in.	mm	psi	MPa	in.	mm	in.	mm	lb./ft.
20339606	1	25.4	1.50	38.1	150	1.03	2	50	29	737	0.59	0.88
20339625	1¼	32.0	1.77	44.8	150	1.03	3	75	29	737	0.74	1.10
20339626	1½	38.0	2.03	51.7	150	1.03	4	100	29	737	0.92	1.37
20339628	2	51.2	2.55	64.9	150	1.03	5	125	29	737	1.21	1.80
20339627	2½	63.7	3.07	77.9	150	1.03	6	150	29	737	1.56	2.32
20339629	3	76.1	3.58	91.0	150	1.03	7	175	29	737	1.94	2.89
20339650	4	102.1	4.60	117.0	150	1.03	10	200	29	737	2.53	3.77

Air & Multipurpose

General Purpose  
Heavy Duty  
Push-on

Chemical Transfer

Cleaning Equipment

Food  
Transfer  
Washdown

Marine

Material Handling  
Abrasives  
Bulk Transfer  
Cement & Concrete

Mining

Petroleum  
Aircraft Fueling  
Dispensing  
Dock  
Transfer

Spray

Steam

Vacuum

LPG Delivery

Water  
Discharge  
Suction & Discharge  
Washdown

Welding

Coupling Systems

Equipment

Appendix

# Infinity™ Fuel Drop Hose



## Product Specifications

### Application

Constructed with the exclusive PVC double helix for superior flexibility, abrasion resistance and low coefficient of friction for ease of maneuverability. Lightweight in construction, it is designed to transfer biodiesel and ethanol blends, gasoline and other petroleum products under pressure, gravity flow or medium suction (up to 23" Hg) at ambient temperature and with an aromatic content of 60% or less.

### Construction Tube

Black Nitrile synthetic rubber (static dissipating)

### Cover

Black Chemivic™ synthetic rubber with orange & green Pliovic® outer helix

### Reinforcement

Synthetic fabric plies with static wire

### Temperature Range

-40°F to 160°F (-40°C to 71°C)

### Packaging

Coiled and polywrapped. For cut length, check with your Continental ContiTech distributors.

### Branding

Example: Infinity™ Drop Hose Continental ContiTech

### Couplings

Use Continental ContiTech Insta-Lock™ Cam & Groove Fittings with this product.

### Order Codes

543-773

## Infinity™

SAP #	ID		Nom. OD		Max. WP		Bend Radius		Vacuum HG		Weight	
	in.	mm	in.	mm	psi	MPa	in.	mm	in.	mm	lb./ft.	kg/m
20414700	2	51.0	2.80	70.50	150	1.03	1.5	1.02	23	584	1.02	1.52
20414701	3	76.0	3.80	95.48	100	0.69	2.0	1.46	23	584	1.46	2.18
20414702	4	102.0	4.80	121.47	75	0.52	2.5	1.73	23	584	1.73	2.57

**Air & Multipurpose**  
General Purpose  
Heavy Duty  
Push-on

Chemical Transfer

Cleaning Equipment

**Food**  
Transfer  
Washdown

Marine

**Material Handling**  
Abrasives  
Bulk Transfer  
Cement & Concrete

Mining

**Petroleum**  
Aircraft Fueling  
Dispensing  
Dock  
Transfer

Spray

Steam

Vacuum

LPG Delivery

**Water**  
Discharge  
Suction & Discharge  
Washdown

Welding

Coupling Systems

Equipment

Appendix

# Infinity™ HD Fuel Drop Hose



## Product Specifications

### Application

Constructed with the exclusive PVC double helix for superior flexibility, abrasion resistance and low coefficient of friction for ease of maneuverability. Lightweight in construction, Infinity™ HD (Heavy Duty) is designed for higher working pressure applications (150 psi). It is suitable in gravity flow or medium suction at ambient temperature. Designed to transfer biodiesel and ethanol blends, gasoline and other petroleum products with an aromatic content of 60% or less.

### Construction Tube

Black Nitrile synthetic rubber (static dissipating)

### Cover

Synthetic fabric plies

### Reinforcement

Black Chemivic® synthetic rubber with double Orange Pliovic® outer helix

### Temperature Range

-40°F to 160°F (-40°C to 71°C)

### Packaging

Coiled and polywrapped. For cut length, check with your Continental ContiTech Authorized Distributor.

### Branding

Infinity™ HD Drop Hose 150psi Continental ContiTech

### Couplings

Use Continental ContiTech Insta-Lock™ Cam & Groove Fittings with this product. See the Coupling Systems information pages at the back of the catalog.

### Order Codes

543-138

## Infinity™ HD Fuel Drop Hose

SAP #	ID		Nom. OD		Max. WP		Bend Radius		Vacuum HG		Weight	
	in.	mm	in.	mm	psi	MPa	in.	mm	in.	mm	lb./ft.	kg/m
20439969	2	51.0	2.80	70.50	150	1.03	1.5	38.1	23	584	1.01	1.51
20439980	3	76.0	3.80	95.90	150	1.03	2.0	50.8	23	584	1.48	2.21
20439981	4	102.0	4.80	122.50	150	1.03	3.0	76.2	23	584	2.01	2.99

**Air & Multipurpose**

- General Purpose
- Heavy Duty
- Push-on

Chemical Transfer

Cleaning Equipment

**Food**

- Transfer
- Washdown

Marine

**Material Handling**

- Abrasives
- Bulk Transfer
- Cement & Concrete

Mining

**Petroleum**

- Aircraft Fueling
- Dispensing
- Dock Transfer

Spray

Steam

Vacuum

LPG Delivery

**Water**

- Discharge
- Suction & Discharge
- Washdown

Welding

Coupling Systems

Equipment

Appendix



# Plicord® Flexwing® Petroleum



## Product Specifications

### Application

For use in tank truck and in-plant operations to transfer gasoline, oil, ethanol blends and other petroleum base products up to 50% aromatic content. It is designed for pressure, gravity flow, or full-suction service.

### Construction Tube

Nitrile synthetic rubber RMA Class A (High Oil Resistance)

### Cover

Black (red spiral stripe) or Red Chemivic™ (white spiral stripe) synthetic rubber (oil resistant); smooth cover; wrapped finish

### Reinforcement

Spiral-plied synthetic fabric with wire helix

### Temperature Range

-35°F to 200°F (-37°C to 93°C)

### Packaging

100' lengths, coiled and polywrapped

### Branding (Spiral)

Example: Continental ContiTech Flexwing® Petroleum 150 psi WP

### Couplings

Use Continental ContiTech Insta-Lock™ Cam & Groove Fittings with this product. See the Coupling Systems information pages at the back of the catalog.

### Order Codes

543-109 (black)  
543-110 (red)  
541-109 (black 8-inch size)

## Plicord® Flexwing® Petroleum

SAP #		ID		Nom. OD		Max. WP		Bend Radius		Vacuum HG		Weight	
Black	Red	in.	mm	in.	mm	psi	MPa	in.	mm	in.	mm	lb./ft.	kg/m
20050548		3/4	19.1	1.22	31.0	150	1.03	2	51	29	737	0.47	0.70
20017481	20392618	1	25.4	1.50	38.1	150	1.03	2	51	29	737	0.63	0.94
20017482	20017530	1¼	31.8	1.76	44.7	150	1.03	3	76	29	737	0.79	1.18
20017488	20017532	1½	38.1	2.03	51.6	150	1.03	4	102	29	737	0.99	1.47
20050549		1¾	44.5	2.28	57.9	150	1.03	4	102	29	737	1.07	1.59
20017496	20017537	2	50.8	2.55	64.8	150	1.03	5	114	29	737	1.30	1.93
20017502	20017541	2½	63.5	3.07	78.0	150	1.03	6	146	29	737	1.66	2.47
20017508	20017543	3	76.2	3.57	90.7	150	1.03	7	178	29	737	2.03	3.02
20017513		3½	88.9	4.13	104.9	150	1.03	8	203	29	737	2.39	3.56
20017516	20017546	4	101.6	4.60	116.8	150	1.03	10	254	29	737	2.68	3.99
20017526		6	152.7	6.78	171.9	150	1.03	30	762	29	737	5.61	8.36

**Air & Multipurpose**  
General Purpose  
Heavy Duty  
Push-on

Chemical Transfer

Cleaning Equipment

**Food**  
Transfer  
Washdown

Marine

**Material Handling**  
Abrasives  
Bulk Transfer  
Cement & Concrete

Mining

**Petroleum**  
Aircraft Fueling  
Dispensing  
Dock  
Transfer

Spray

Steam

Vacuum

LPG Delivery

**Water**  
Discharge  
Suction & Discharge  
Washdown

Welding

Coupling Systems

Equipment

Appendix

# Paladin®

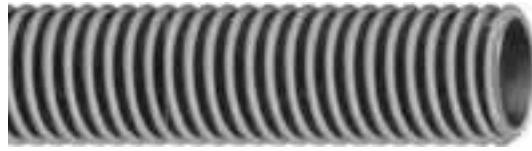

## Product Specifications

### Application

Designed as a lightweight and flexible hose to transfer biodiesel and ethanol blends, gasoline and other petroleum products under pressure, gravity flow or medium suction (up to 23" Hg) at ambient temperature. Maximum aromatic content 60%. Outer PVC helix provides abrasion resistance and low coefficient of friction. With Antistatic wire (low resistance).

### Construction Tube

Black Nitrile synthetic rubber (static dissipating)

### Cover

Black Chemivic® synthetic rubber with double Orange Pliovic® outer helix

### Reinforcement

Synthetic fabric plies

### Temperature Range

-40°F to 160°F (-40°C to 71°C)

### Packaging

100' lengths, coiled and bagel pack

### Branding

Example: Continental ContiTech Paladin® Drop Hose (Date Code). Made in Canada

### Couplings

Use Continental ContiTech Insta-Lock™ Cam & Groove Fittings with this product. See the Coupling Systems information pages at the back of the catalog.

### Order Codes

543-138

## Paladin®

SAP #	ID		Nom. OD		Max. WP		Bend Radius		Vacuum HG		Weight	
	in.	mm	in.	mm	psi	MPa	in.	mm	in.	mm	lb./ft.	kg/m
20130856	2	50.8	2.87	72.9	150	1.03	2	51	23	584	1.04	1.55
20130857	3	76.2	3.92	99.6	150	1.03	3	76	23	584	1.58	2.35
20131000	4	101.6	4.85	123.2	75	0.52	5	127	23	584	1.94	2.89

Air & Multipurpose

General Purpose

Heavy Duty

Push-on

Chemical Transfer

Cleaning Equipment

Food

Transfer

Washdown

Marine

Material Handling

Abrasives

Bulk Transfer

Cement & Concrete

Mining

Petroleum

Aircraft Fueling

Dispensing

Dock

Transfer

Spray

Steam

Vacuum

LPG Delivery

Water

Discharge

Suction & Discharge

Washdown

Welding

Coupling Systems

Equipment

Appendix

# Red Flextra®



## Product Specifications

### Application

For the transfer of ethanol blends, gasoline and other petroleum-based products under pressure, gravity flow or full-suction where maximum flexibility is needed.

### Construction Tube

Nitrile synthetic rubber RMA Class A (High Oil Resistance)

### Cover

Red Wingprene®, corrugated synthetic rubber RMA Class C (Oil Resistance)

### Reinforcement

Spiral-plied synthetic fabric with double wire helix

### Temperature Range

-30°F to 180°F (-34°C to 82°C)

### Red Flextra® 100

Order Codes: 543-123

SAP #	ID		Nom. OD		Max. WP		Bend Radius		Vacuum HG		Weight	
	in.	mm	in.	mm	psi	MPa	in.	mm	in.	mm	lb./ft.	kg/m
20017589	2	50.8	2.38	60.3	100	0.69	4	102	29	737	0.83	1.09
20017593	2½	63.5	2.88	73.2	100	0.69	5	127	29	737	1.09	1.62
20017598	3	76.2	3.41	86.6	100	0.69	6	152	29	737	1.41	2.10
20017600	4	101.6	4.53	115.1	100	0.69	9	229	29	737	2.23	3.32

### Red Flextra® 150

Order Codes: 543-120

SAP #	ID		Nom. OD		Max. WP		Bend Radius		Vacuum HG		Weight	
	in.	mm	in.	mm	psi	MPa	in.	mm	in.	mm	lb./ft.	kg/m
20017582	2	50.8	2.52	64.0	150	1.03	4	102	29	737	1.18	1.76
20017583	3	76.2	3.59	91.2	150	1.03	6	152	29	737	1.99	2.96
20017584	4	101.6	4.61	117.1	150	1.03	9	229	29	737	2.66	3.96

### Packaging

100' lengths, coiled and polywrapped

### Branding (Spiral)

Example: Continental ContiTech Red Flextra®. Made in Canada

### Couplings

Use Continental ContiTech Insta-Lock Cam & Groove Fittings with this product. See the Coupling Systems information pages at the back of the catalog.

**Air & Multipurpose**  
General Purpose  
Heavy Duty  
Push-on

Chemical Transfer

Cleaning Equipment

**Food**  
Transfer  
Washdown

Marine

**Material Handling**  
Abrasives  
Bulk Transfer  
Cement & Concrete

Mining

**Petroleum**  
Aircraft Fueling  
Dispensing  
Dock  
Transfer

Spray

Steam

Vacuum

LPG Delivery

**Water**  
Discharge  
Suction & Discharge  
Washdown

Welding

Coupling Systems

Equipment

Appendix

# Plicord® Super Black Flexwing®



## Product Specifications

### Application

A premium high-pressure petroleum transfer hose for handling ethanol blends, gasoline, oils and other petroleum products at higher working pressures.

### Construction Tube

Special fuel-resistant Black nitrile synthetic rubber RMA Class A (High Oil Resistance)

### Cover

Black Chemivic™ smooth cover with wrapped finish. Also available with ARC treatment for improved abrasion resistance. Both hoses standard with built in blue wear ply to illustrate wear condition and potential trigger point for product replacement.

### Reinforcement

Spiral-plied synthetic fabric with wire helix

### Temperature Range

-35°F to 200°F (-37°C to 93°C)

### Packaging

100' lengths, coiled and polywrapped

### Branding

Example: Continental ContiTech Flexwing® Petroleum Hose

### Couplings

Use Continental ContiTech Insta-Lock™ Cam & Groove Fittings with this product. See the Coupling Systems information pages at the back of the catalog.

### Order Codes

543-117  
541-117 (6" diameter, 100' length)

## Plicord Super Black Flexwing®

SAP #	ID		Nom. OD		Max. WP		Bend Radius		Vacuum HG		Weight	
	in.	mm	in.	mm	psi	MPa	in.	mm	in.	mm	lb./ft.	kg/m
20155914	1¼	31.8	1.87	47.1	300	2.07	4	100	29	737	.99	1.48
20017550	1½	38.1	2.08	52.8	300	2.07	4	100	29	737	1.15	1.71
20017552	2	50.8	2.59	65.8	300	2.07	5	125	29	737	1.44	2.14
20017558	2½	63.5	3.11	79.0	300	2.07	6	150	29	737	1.84	2.74
20017560	3	76.2	3.65	92.7	300	2.07	7	175	29	737	2.39	3.56
20017564	4	101.6	4.83	122.7	300	2.07	10	254	29	737	3.76	5.60
20017568	5	127.0	5.87	149.0	300	2.07	20	500	29	737	5.10	7.60
20338990	6	152.4	7.21	183.3	300	2.07	24	600	29	737	8.46	12.60

**Air & Multipurpose**

- General Purpose
- Heavy Duty
- Push-on

Chemical Transfer

Cleaning Equipment

- Food Transfer
- Washdown

Marine

**Material Handling**

- Abrasives
- Bulk Transfer
- Cement & Concrete

Mining

**Petroleum**

- Aircraft Fueling
- Dispensing
- Dock Transfer

Spray

Steam

Vacuum

LPG Delivery

- Water Discharge

- Suction & Discharge
- Washdown

Welding

Coupling Systems

Equipment

Appendix

# Plicord® Oilfield Frac



## Product Specifications

### Application

A rugged and flexible hose designed to convey crude oil and oil slurry mixtures for Frac tank connections.

### Construction Tube

Black Nitrile

### Cover

Black Chemivic™, smooth cover with wrapped finish. Also available with ARC treatment for improved abrasion resistance.

### Reinforcement

Multiple plies of synthetic fabric

### Temperature Range

-25°F to 180°F (-32°C to 82°C)

### Plicord® Oilfield Frac

SAP #	ID	Nom. OD		Max. WP		Weight		
		in.	mm	psi	MPa	lb./ft.	kg/m	
20118130	3	76.2	3.87	98.30	400	2.76	2.52	3.74
20018362	4	101.6	4.76	120.85	400	2.76	2.85	4.21

### Packaging

100' length, coiled and polywrapped

### Branding (Spiral)

Continental ContiTech Oilfield Fracturing Hose

### Couplings

Contact fitting supplier

### Order Codes

543-827  
543-710 (ARC Treatment)  
541-710

**Air & Multipurpose**  
General Purpose  
Heavy Duty  
Push-on

Chemical Transfer

Cleaning Equipment

**Food**  
Transfer  
Washdown

Marine

**Material Handling**  
Abrasives  
Bulk Transfer  
Cement & Concrete

Mining

**Petroleum**  
Aircraft Fueling  
Dispensing  
Dock  
Transfer

Spray

Steam

Vacuum

LPG Delivery

**Water**  
Discharge  
Suction & Discharge  
Washdown

Welding

Coupling Systems

Equipment

Appendix

# Plicord® LW Black Flextra II™



## Product Specifications

### Application

Used by tank trucks, bulk petroleum stations, and others to transfer ethanol blends and petroleum products under pressure, suction and/or gravity flow. Extremely flexible and lightweight to provide excellent service. Not recommended where aromatic content exceeds 50%.

### Construction Tube

Black Nitrile RMA Class A (High Oil Resistance)

### Cover

Black Chemivic™ (corrugated)

### Reinforcement

Spiral-plied synthetic fabric with double wire helix

### Temperature Range

-40°F to 180°F (-40°C to 82°C)

### Packaging

100' lengths, coiled and polywrapped

### Branding (Spiral)

Example: Continental ContiTech LW Black Flextra II™ 75 psi Max WP

### Couplings

Contact fitting manufacturer for proper fitting recommendation and coupling procedure.

### Order Codes

543-562

## Plicord® LW Black Flextra II™

SAP #	ID		Nom. OD		Max. WP		Bend Radius		Vacuum HG		Weight	
	in.	mm	in.	mm	psi	MPa	in.	mm	in.	mm	lb./ft.	kg/m
20017959	2	50.8	2.42	61.5	75	0.52	3	76	29	737	0.94	1.40
20017961	2½	63.5	2.92	74.2	75	0.52	4	102	29	737	1.22	1.82
20017962	3	76.2	3.40	86.4	75	0.52	4	102	29	737	1.39	2.07
20017965	4	101.6	4.53	115.1	75	0.52	7	178	29	737	2.37	3.53

Air & Multipurpose

General Purpose

Heavy Duty

Push-on

Chemical Transfer

Cleaning Equipment

Food

Transfer

Washdown

Marine

Material Handling

Abrasives

Bulk Transfer

Cement & Concrete

Mining

Petroleum

Aircraft Fueling

Dispensing

Dock

Transfer

Spray

Steam

Vacuum

LPG Delivery

Water

Discharge

Suction & Discharge

Washdown

Welding

Coupling Systems

Equipment

Appendix

# Prospector™ Oilfield 150



## Product Specifications

### Application

For use in transfer hose service, cleaning sediment from oil storage tanks and other general service applications. The tube is an oil-resistant synthetic rubber. Do not use with gasoline and other refined products when aromatic content exceeds 35%.

### Construction Tube

Synthetic rubber

### Cover

Black SBR synthetic rubber (smooth cover)

### Reinforcement

Spiral-plied synthetic fabric with wire helix

### Temperature Range

-25°F to 180°F (-32°C to 82°C)

### Packaging

100' lengths, coiled and polywrapped

### Branding (Spiral)

Example: Continental ContiTech Prospector™ Oilfield 150

### Couplings

Use Continental ContiTech Insta-Lock Cam & Groove Fittings with this product. See the Coupling Systems information pages at the back of the catalog.

### Order Codes

543-655

## Prospector™ Oilfield 150

SAP #	ID	Nom. OD		Max. WP		Vacuum HG		Weight		Order Code
Black	in.	mm	in.	mm	psi	MPa	in.	lb./ft.	kg/m	Black
20018018	1	25.4	1.49	37.8	150	1.03	29	0.64	0.95	543-456
20018020	1¼	31.75	1.74	44.2	150	1.03	29	0.77	1.14	
20018023	1½	38.1	1.99	50.6	150	1.03	29	0.91	1.36	
20018028	2	50.8	2.49	63.2	150	1.03	29	1.71	1.74	
20018031	2½	63.5	3.01	76.4	150	1.03	29	1.48	2.20	
20018034	3	76.2	3.54	89.9	150	1.03	29	1.91	2.84	
20018037	4	101.6	4.59	116.5	150	1.03	29	2.82	4.19	
20018042	6	152.4	6.76	171.7	150	1.03	29	5.75	8.56	

**Air & Multipurpose**  
General Purpose  
Heavy Duty  
Push-on

Chemical Transfer

Cleaning Equipment

**Food**  
Transfer  
Washdown

Marine

**Material Handling**  
Abrasives  
Bulk Transfer  
Cement & Concrete

Mining

**Petroleum**  
Aircraft Fueling  
Dispensing  
Dock  
Transfer

Spray

Steam

Vacuum

LPG Delivery

**Water**  
Discharge  
Suction & Discharge  
Washdown

Welding

Coupling Systems

Equipment

Appendix

# Prospector™ Oilfield 300



## Product Specifications

### Application

Transfer of oil or liquid slurries.

### Construction Tube

Nitrile

### Cover

Black SBR

### Reinforcement

Spiral-plies fabric with wire helix

### Temperature Range

-35°F to 180°F (-37°C to 82°C)

### Packaging

100' lengths, coiled and polywrapped

### Branding (Spiral)

Example: Continental ContiTech Prospector™ Oilfield 300

### Couplings

Contact fitting manufacturer for proper fitting recommendation and coupling procedure

### Stock Length

100 ft

### Order Codes

543-098

### Rating

300 psi and full vacuum

## Prospector™ Oilfield 300

SAP #	Nom ID		Nom. OD		Max. WP		Weight		Order Code
	in.	mm	in.	mm	psi	MPa	lb./ft.	kg/m	Black
20464301	2	51.1	2.5	64.3	300	2.07	1.21	0.17	543-098
20464302	3	76.1	3	90.8	300	2.07	1.97	0.27	
20464303	4	102.1	4.7	119.7	300	2.07	3.16	0.44	
20531361	5	127.4	5.9	150.3	300	2.07	5.34	0.74	
20464305	6	152.4	6.9	175.4	300	2.07	6.66	9.91	

**Air & Multipurpose**

- General Purpose
- Heavy Duty
- Push-on

Chemical Transfer

Cleaning Equipment

**Food**

- Transfer
- Washdown

Marine

**Material Handling**

- Abrasives
- Bulk Transfer
- Cement & Concrete

Mining

**Petroleum**

- Aircraft Fueling
- Dispensing
- Dock Transfer

Spray

Steam

Vacuum

LPG Delivery

**Water**

- Discharge
- Suction & Discharge
- Washdown

Welding

Coupling Systems

Equipment

Appendix



# LW Arctic Tank Truck



## Product Specifications

### Application

For transfer of petroleum-based products under suction, low-pressure discharge or gravity flow. Flexibility maintained down to -65°F (-54°C).

### Construction Tube

Black Nitrile RMA Class A (High Oil Resistance)

### Cover

Blue Wingprene® (corrugated)

### Reinforcement

Spiral-plied synthetic fabric with double wire helix

### Temperature Range

-65°F to 180°F (-54°C to 82°C)

### Packaging

100' lengths, coiled and polywrapped

### Branding (Spiral)

Example: Continental ContiTech LW Arctic Tank Truck 150 psi/10 Bar

### Couplings

Contact fitting manufacturer for proper fitting recommendation and coupling procedure.

### Order Codes

543-365

## LW Arctic Tank Truck

SAP #	ID		Nom. OD		Max. WP		Bend Radius		Vacuum HG		Weight	
	in.	mm	in.	mm	psi	MPa	in.	mm	in.	mm	lb./ft.	kg/m
20017813	2	50.8	2.53	64.3	200	1.38	4	100	29	737	1.11	1.64
20117198	2½	63.5	3.02	76.7	150	1.03	5	125	29	737	1.42	2.11
20017814	3	76.2	3.55	90.2	150	1.03	6	150	29	737	1.83	2.72
20017815	4	101.6	4.61	117.1	150	1.03	9	225	29	737	2.62	3.90

**Air & Multipurpose**  
General Purpose  
Heavy Duty  
Push-on

Chemical Transfer

Cleaning Equipment

**Food**  
Transfer  
Washdown

Marine

**Material Handling**  
Abrasives  
Bulk Transfer  
Cement & Concrete

Mining

**Petroleum**  
Aircraft Fueling  
Dispensing  
Dock  
Transfer

Spray

Steam

Vacuum

LPG Delivery

**Water**  
Discharge  
Suction & Discharge  
Washdown

Welding

Coupling Systems

Equipment

Appendix

# Plicord® Arctic Flexwing™



## Product Specifications

### Application

Plicord® Arctic Flexwing® is for use in low-temperature operations for transferring gasoline, oil and other petroleum products.

### Construction Tube

Ultra-low temperature oil resistant synthetic rubber RMA Class A (High Oil Resistance)

### Cover

Blue ultra-low temperature synthetic rubber RMA Class A (High Oil Resistance) with red spiral stripe. Smooth cover, wrapped finish

### Reinforcement

Spiral-plied synthetic fabric with wire helix

### Temperature Range

-65°F to 180°F (-54°C to 82°C)

### Packaging

100' lengths, coiled and polywrapped

### Branding (Spiral)

Example: Continental ContiTech Arctic Flexwing® 150 psi WP

### Couplings

Use Continental ContiTech Insta-Lock™ Cam & Groove Fittings with this product. See the Coupling Systems information pages at the back of the catalog.

### Order Codes

543-650

## Plicord® Arctic Flexwing™

SAP #	ID		Nom. OD		Max. WP		Bend Radius		Vacuum HG		Weight	
	in.	mm	in.	mm	psi	MPa	in.	mm	in.	mm	lb./ft.	kg/m
20017996	1¼	31.8	1.73	43.9	150	1.03	3	80	29	737	0.66	0.98
20017997	1½	38.1	1.98	50.3	150	1.03	4	102	29	737	0.82	1.22
20018001	2	50.8	2.50	63.5	150	1.03	5	127	29	737	1.07	1.59
20018002	2½	63.5	3.09	78.5	150	1.03	6	152	29	737	1.64	2.44
20018004	3	76.2	3.58	90.9	150	1.03	7	178	29	737	1.92	2.86
20018005	4	101.6	4.70	119.4	150	1.03	10	254	29	737	2.88	4.29

Air & Multipurpose

General Purpose

Heavy Duty

Push-on

Chemical Transfer

Cleaning Equipment

Food

Transfer

Washdown

Marine

Material Handling

Abrasives

Bulk Transfer

Cement & Concrete

Mining

Petroleum

Aircraft Fueling

Dispensing

Dock

Transfer

Spray

Steam

Vacuum

LPG Delivery

Water

Discharge

Suction & Discharge

Washdown

Welding

Coupling Systems

Equipment

Appendix

# Plicord® Fuel Discharge



## Product Specifications

### Application

Plicord® Fuel Discharge hose is for the discharge of gasoline, oil, ethanol blends and other petroleum based products in tank and industrial applications.

### Construction Tube

Nitrile synthetic rubber RMA Class A (High Oil Resistance), plus antistatic wires

### Cover

Black Chemivic™ synthetic rubber RMA Class B (Medium-High Oil Resistance)

### Reinforcement

Spiral-plied synthetic fabric (2"-4": 2 ply; 6": 4 ply), plus grounding wires

### Temperature Range

-35°F to 180°F (-37°C to 82°C)

### Plicord® Fuel Discharge

Order Codes: 543-123

SAP #	ID		Nom. OD		Max. WP		Weight	
	in.	mm	in.	mm	psi	MPa	lb./ft.	kg/m
20032339	3/4	19.1	1.21	30.7	150	1.03	0.42	0.63
20032357	1	25.4	1.46	37.1	150	1.03	0.52	0.77
20050546	1¼	31.8	1.72	43.7	150	1.03	0.63	0.94
20017756	1½	38.1	1.95	49.5	150	1.03	0.73	1.09
20017758	2	50.8	2.49	63.3	150	1.03	0.98	1.46
20032358	2½	63.5	2.98	75.7	150	1.03	1.19	1.77
20017764	3	76.2	3.50	88.9	150	1.03	1.45	2.16
20050547	3½	88.9	4.04	102.6	150	1.03	1.70	2.53
20017767	4	101.6	4.52	114.8	150	1.03	1.91	2.84
20126041	6	152.4	6.63	168.4	150	1.03	3.41	5.07

### Packaging

100' length, coiled and polywrapped

### Branding (Spiral)

Example: Continental ContiTech Plicord® Fuel Discharge

### Couplings

Use Continental ContiTech Insta-Lock™ Cam & Groove Fittings with this product. See the Coupling Systems information pages at the back of the catalog.

### Order Codes

543-331

**Air & Multipurpose**  
General Purpose  
Heavy Duty  
Push-on

Chemical Transfer

Cleaning Equipment

**Food**  
Transfer  
Washdown

Marine

**Material Handling**  
Abrasives  
Bulk Transfer  
Cement & Concrete

Mining

**Petroleum**  
Aircraft Fueling  
Dispensing  
Dock  
Transfer

Spray

Steam

Vacuum

LPG Delivery

**Water**  
Discharge  
Suction & Discharge  
Washdown

Welding

Coupling Systems

Equipment

Appendix

# Plicord® ExtremeFlex™ Petroleum Transfer



## Product Specifications

### Application

An extremely flexible and lightweight drop hose for use in tank truck and in-plant operation to transfer diesel, ethanol, gasoline, oil and petroleum base products up to 60% aromatic content. Corrugated construction for lower drag coefficient and superior abrasion resistance.

### Construction Tube

Black Nitrile synthetic rubber (Class A oil resistance)

### Cover

Black Chemivic™ synthetic (corrugated)

### Reinforcement

Spiral plied synthetic fabric with wire helix

### Temperature Range

-40°F to 200°F (-40°C to 93°C)

### Packaging

100' lengths, coiled and bagel packed

### Branding (Spiral)

Example: Plicord® ExtremeFlex™ Petroleum Transfer

### Couplings

Use Continental ContiTech Insta-Lock™ Cam & Groove Fittings.

### Order Codes

543-216

## Plicord® ExtremeFlex™ Petroleum Transfer

SAP #	ID	Nom. OD		Max. WP		Bend Radius		Vacuum HG		Weight		
		in.	mm	in.	mm	in.	mm	in.	mm	lb./ft.	kg/m	
20459042	3/4	19.1	1.20	30.5	250	1.72	.75	19	29	737	0.44	0.65
20459043	1	25.4	1.45	36.8	250	1.72	1	25	29	737	0.55	0.81
20459044	1½	38.1	1.91	48.5	250	1.72	1.5	38	29	737	0.73	1.08
20459045	2	50.8	2.43	61.8	250	1.72	2	51	29	737	0.96	1.43
20459046	2½	63.5	3.00	76.1	200	1.37	2.5	64	29	737	1.41	2.10
20459047	3	76.2	3.50	88.8	200	1.37	3	76	29	737	1.69	2.51
20459048	4	101.6	4.56	115.7	150	1.03	4	101	29	737	2.42	3.61
20546328	6	152.4	6.62	168.4	150	1.03	6	146	29	737	4.43	2.01



Air & Multipurpose  
General Purpose  
Heavy Duty  
Push-on

Chemical Transfer

Cleaning Equipment

Food  
Transfer  
Washdown

Marine

Material Handling  
Abrasives  
Bulk Transfer  
Cement & Concrete

Mining

Petroleum  
Aircraft Fueling  
Dispensing  
Dock  
Transfer

Spray

Steam

Vacuum

LPG Delivery

Water  
Discharge  
Suction & Discharge  
Washdown

Welding

Coupling Systems

Equipment

Appendix

# Spiraflex® Polyurethane Vapor Recovery



## Product Specifications

### Application

For the recovery of gasoline vapors in tank truck loading at bulk terminals and in tank truck unloading at service stations.

### Construction Tube

Transparent polyurethane

### Cover

Transparent polyurethane

### Reinforcement

Red rigid Pliovic® helix, available with static wire placed between the tube and cover

### Temperature Range

-30°F to 150°F (-34°C to 66°C)

### Packaging

100' lengths, coiled and polywrapped

### Branding

Not branded

### Couplings

Contact fitting manufacturer for proper fitting recommendation and coupling procedure.

### Order Codes

586-465 (without static wire)  
586-468 (static wire)

## Spiraflex® Polyurethane Vapor Recovery

SAP #	ID	Nom. OD		Max. WP		Bend Radius		Weight			
		in.	mm	in.	mm	in.	mm	lb./ft.	kg/m		
20562108	20013586	2	50.8	2.47	62.7	30	0.21	3	76	0.57	0.85
20013561	20013587	3	76.2	3.41	86.6	20	0.14	4	102	0.68	1.01
20013562	20013588	4	101.6	4.51	114.6	15	0.10	7	178	0.98	1.46

Air & Multipurpose  
General Purpose  
Heavy Duty  
Push-on

Chemical Transfer

Cleaning Equipment

Food  
Transfer  
Washdown

Marine

Material Handling  
Abrasives  
Bulk Transfer  
Cement & Concrete

Mining

Petroleum  
Aircraft Fueling  
Dispensing  
Dock  
Transfer

Spray

Steam

Vacuum

LPG Delivery

Water  
Discharge  
Suction & Discharge  
Washdown

Welding

Coupling Systems

Equipment

Appendix

# Pyroflex® Hot Tar & Asphalt II



## Product Specifications

### Application

For the transfer of high temperature petroleum-based materials such as tar, asphalt and hot oils. It is suitable for suction and discharge service on tank trucks, tank cars or at bulk stations. Heat resistant tube and aramid reinforcement. (Hot oils only rated to 200°F/93°C)

### Construction Tube

Black Nitrile (special heat resistant) synthetic rubber RMA Class A (High Oil Resistance)

### Cover

Black Wingprene® synthetic rubber RMA Class A (High Oil Resistance) with spiral red stripe

### Reinforcement

Spiral-plied aramid with wire helix

### Temperature Range

-25°F to 350°F (-32°C to 177°C)

### Packaging

100' lengths, coiled and polywrapped

### Branding (Spiral)

Example: Continental ContiTech Pyroflex® Hot Tar and Asphalt II 150 psi

### Couplings

Contact fitting manufacturer for proper fitting recommendation and coupling procedure.

### Order Codes

543-118

## Pyroflex® Hot Tar & Asphalt II

SAP #	ID		Nom. OD		Max. WP		Bend Radius		Vacuum HG		Weight	
	in.	mm	in.	mm	psi	MPa	in.	mm	in.	mm	lb./ft.	kg/m
20017573	1½	38.1	2.08	52.8	150	1.03	4	102	29	737	1.04	1.55
20017574	2	50.8	2.60	66.0	150	1.03	5	127	29	737	1.33	1.98
20046059	2½	63.5	3.09	78.6	150	1.03	6	152	29	737	1.67	2.49
20017578	3	76.2	3.65	92.8	150	1.03	7	178	29	737	2.23	3.32
20017580	4	101.6	4.68	118.8	150	1.03	10	254	29	737	2.91	4.34

Air & Multipurpose

General Purpose  
Heavy Duty  
Push-on

Chemical Transfer

Cleaning Equipment

Food  
Transfer  
Washdown

Marine

Material Handling  
Abrasives  
Bulk Transfer  
Cement & Concrete

Mining

Petroleum  
Aircraft Fueling  
Dispensing  
Dock  
Transfer

Spray

Steam

Vacuum

LPG Delivery

Water  
Discharge  
Suction & Discharge  
Washdown

Welding

Coupling Systems

Equipment

Appendix

# Pyroflex® Hot Tar Wand



## Product Specifications

### Application

A high-quality wand hose used in asphalt crack filling applicator and dispensing service.

### Construction Tube

Black Nitrile (special heat resistance)

### Cover

Black Wingprene® (wrapped finish) flame-retardant

### Reinforcement

Spiral-plied (2) steel wire

### Temperature Range

-25°F to 350°F (-32°C to 177°C)

### Packaging

100' lengths, coiled and polywrapped

### Branding (Spiral)

Example: Continental ContiTech Pyroflex® Hot Tar Wand Hose

### Couplings

Contact fitting manufacturer for proper fitting recommendation and coupling procedure.

### Order Codes

543-632

## Pyroflex® Hot Tar Wand

SAP #	ID		Nom. OD		Max. WP		Weight	
	in.	mm	in.	mm	psi	MPa	lb./ft.	kg/m
20017982	3/4	19.1	1.33	33.8	300	2.07	0.64	0.95
20017987	1	25.4	1.61	40.9	300	2.07	0.84	1.25
20156594	1½	38.1	2.11	53.6	300	2.07	1.15	1.71

**Air & Multipurpose**  
General Purpose  
Heavy Duty  
Push-on

Chemical Transfer

Cleaning Equipment

**Food**  
Transfer  
Washdown

Marine

**Material Handling**  
Abrasives  
Bulk Transfer  
Cement & Concrete

Mining

**Petroleum**  
Aircraft Fueling  
Dispensing  
Dock  
Transfer

Spray

Steam

Vacuum

LPG Delivery

**Water**  
Discharge  
Suction & Discharge  
Washdown

Welding

Coupling Systems

Equipment

Appendix

# Alternative Fuel Compatibility For Tubes and Covers Of Continental ContiTech Fuel Transfer Hoses

Air & Multipurpose  
General Purpose  
Heavy Duty  
Push-on

Chemical Transfer

Cleaning Equipment

Food  
Transfer  
Washdown

Marine

Material Handling  
Abrasives  
Bulk Transfer  
Cement & Concrete

Mining

**Petroleum**  
Aircraft Fueling  
Dispensing  
Dock  
Transfer

Spray

Steam

Vacuum

LPG Delivery

**Water**  
Discharge  
Suction & Discharge  
Washdown

Welding

Coupling Systems

Equipment

Appendix

## Compatibility by Product

All Continental ContiTech Fuel Transfer Hoses are compatible with gasoline and diesel

Hose Tube & Cover Compatibility Ethanol & Biodiesel

Product	Product Code	Aromatic Content	E-100 100% Ethanol	E-85 85% Ethanol	E-15 15% Ethanol	B-100 100% Biodiesel	B-50 50% Biodiesel	B-20 20% Biodiesel
Infinity	543-773	60%	Tube & Cover	Tube & Cover	Tube & Cover	Tube & Cover	Tube & Cover	Tube & Cover
Infinity HD	543-138	60%	Tube & Cover	Tube & Cover	Tube & Cover	Tube & Cover	Tube & Cover	Tube & Cover
Infinity HD LT	543-663	60%	Tube & Cover	Tube & Cover	Tube & Cover	No	No	No
Flexwing VersaFuel	543-422	60%	Tube & Cover	Tube & Cover	Tube & Cover	Tube & Cover	Tube & Cover	Tube & Cover
Flexwing VersaFuel Flex	543-636	60%	Tube & Cover	Tube & Cover	Tube & Cover	Tube & Cover	Tube & Cover	Tube & Cover
Plicord ExtremeFlex	543-216	60%	Tube & Cover	Tube & Cover	Tube & Cover	No	No	No
Plicord Flexwing Petroleum	543-109	60%	Tube & Cover	Tube & Cover	Tube & Cover	No	No	No
Red Flextra	543-123, 543-120	60%	Tube & Cover	Tube & Cover	Tube & Cover	No	No	No
Paladin	543-227	60%	Tube & Cover	Tube & Cover	Tube & Cover	Tube & Cover	Tube & Cover	Tube & Cover
Plicord Super Black Flexwing®	543-117	60%	Tube & Cover	Tube & Cover	Tube & Cover	No	No	No
Plicord LW Black Flextra II	543-562	50%	Tube & Cover	Tube & Cover	Tube & Cover	No	No	No
Plicord Arctic Flexwing	543-650	50%	Tube & Cover	Tube & Cover	No	No	No	No
LW Arctic Tank Truck	543-365	50%	Tube & Cover	Tube & Cover	No	No	No	No



# Spray



	Page	Rubber	Thermoplastic	Textile	Wire	Temp. Range	MSHA
Mine Spray	137	Yes			Yes	0°F to 200°F	Yes
NR Spray	201	Yes		Yes		0°F to 190°F	
Pliovic® Ag Spray (1800 & 2400)	202		Yes	Yes		0°F to 158°F	

**Air & Multipurpose**  
 General Purpose  
 Heavy Duty  
 Push-on

Chemical Transfer

Cleaning Equipment

**Food**  
 Transfer  
 Washdown

Marine

**Material Handling**  
 Abrasives  
 Bulk Transfer  
 Cement & Concrete

Mining

**Petroleum**  
 Aircraft Fueling  
 Dispensing  
 Dock  
 Transfer

Spray

Steam

Vacuum

LPG Delivery

**Water**  
 Discharge  
 Suction & Discharge  
 Washdown

Welding

Coupling Systems

Equipment

Appendix

# NR Spray



## Product Specifications

### Application

NR Spray is a premium-quality, all-purpose hose for handling a variety of applications such as paint spray or agricultural spray. Will handle spraying paints, automotive finish paints, lacquers, thinners, turpentine, air, oil and a large variety of solvents and chemicals.

### Construction Tube

Nylon, silicone-free

### Cover

Black synthetic rubber, RMA Class B (Medium Oil Resistance)

### Reinforcement

Braided synthetic yarn (1/4" and 3/8"-1 braid) (1/2", 3/4" and 1"-2 braid)

### Temperature Range

0°F to 190°F (-18°C to 88°C)

### Packaging

500' reel, maximum 3 pieces, 50' minimum

### Branding

Example: Continental ContiTech 1/4" IBD NR Spray. Made in U.S.A.

### Couplings

Contact fitting manufacturer for proper fitting recommendation and coupling procedure.

### Order Codes

536-290

## NR Spray

SAP #	ID		Nom. OD		Max. WP		Weight	
	in.	mm	in.	mm	psi	MPa	lb./ft.	kg/m
20022944	1/4	6.4	0.49	12.4	750	5.17	0.08	0.12
20106900	5/16	7.9	0.61	15.5	750	5.17	0.13	0.19
20022951	3/8	9.5	0.70	17.8	750	5.17	0.15	0.22
20022962	1/2	12.7	0.87	22.1	750	5.17	0.22	0.33
20022967	5/8	15.9	1.05	26.7	750	5.17	0.31	0.46
20022969	3/4	19.1	1.19	30.2	750	5.17	0.36	0.54
20022976	1	25.4	1.51	38.4	750	5.17	0.54	0.80

### Air & Multipurpose

General Purpose

Heavy Duty

Push-on

Chemical Transfer

Cleaning Equipment

Food

Transfer

Washdown

Marine

Material Handling

Abrasives

Bulk Transfer

Cement & Concrete

Mining

Petroleum

Aircraft Fueling

Dispensing

Dock

Transfer

Spray

Steam

Vacuum

LPG Delivery

Water

Discharge

Suction & Discharge

Washdown

Welding

Coupling Systems

Equipment

Appendix

# Pliovic® AG Spray

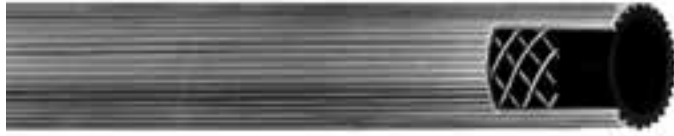

## Product Specifications

### Application

A lightweight, economical high-pressure hose for carrying air, water and many spray solutions in agricultural applications: including Xylene up to 10% concentration. Safety factor 3:1.

### Construction Tube

Pliovic® RMA Class B (Medium Oil Resistance)

### Cover

Orange or green Pliovic® (ribbed finish)

### Reinforcement

Spiral synthetic yarn

### Temperature Range

0°F to 158°F (-18°C to 70°C)

### Pliovic® 1800 (Orange)

Order Codes: 540-211

SAP #	ID		Nom. OD		Max. WP		Weight	
	in.	mm	in.	mm	psi	MPa	lb./ft.	kg/m
20012638	3/8	9.5	0.69	17.5	600	4.14	0.14	0.21
20012641	1/2	12.7	0.78	19.8	600	4.14	0.19	0.28
20012643	3/4	19.1	1.10	27.9	600	4.14	0.28	0.42

### Pliovic® 2400 (Green)

Order Codes: 540-208

SAP #	ID		Nom. OD		Max. WP		Weight	
	in.	mm	in.	mm	psi	MPa	lb./ft.	kg/m
20012626	3/8	9.5	0.70	17.8	800	5.52	0.14	0.21
20012632	1/2	12.7	0.85	21.6	800	5.52	0.20	0.30
20012635	3/4	19.1	1.10	27.9	800	5.52	0.28	0.42

### Packaging

300' length, coiled and polywrapped

### Branding

Example: Continental ContiTech Pliovic® 1800 Spray 1/2" (12.7mm). Made in U.S.A.

### Couplings

Contact fitting manufacturer for proper fitting recommendation and coupling procedure.

**Air & Multipurpose**  
General Purpose  
Heavy Duty  
Push-on

Chemical Transfer

Cleaning Equipment

**Food**  
Transfer  
Washdown

Marine

**Material Handling**  
Abrasives  
Bulk Transfer  
Cement & Concrete

Mining

**Petroleum**  
Aircraft Fueling  
Dispensing  
Dock  
Transfer

Spray

Steam

Vacuum

LPG Delivery

**Water**  
Discharge  
Suction & Discharge  
Washdown

Welding

Coupling Systems

Equipment

Appendix

# Steam



**Air & Multipurpose**  
 General Purpose  
 Heavy Duty  
 Push-on

Chemical Transfer

Cleaning Equipment

**Food**  
 Transfer  
 Washdown

Marine

**Material Handling**  
 Abrasives  
 Bulk Transfer  
 Cement & Concrete

Mining

**Petroleum**  
 Aircraft Fueling  
 Dispensing  
 Dock  
 Transfer

Spray

**Steam**

Vacuum

LPG Delivery

**Water**  
 Discharge  
 Suction & Discharge  
 Washdown

Welding

Coupling Systems

Equipment

Appendix

	Page	Temp. Range	Smooth Cover	Wrapped Cover	Colors	Crimped Assembly
Crimped Steam Assembly	218	-40°F to 450°F	Yes	Yes	Red/Black	Yes
Flexsteel 250 CB Steam	216	-40°F to 425°F		Yes	Red/Black	
Flexsteel 250 CB Extreme	217	-40°F to 425°F		Yes	Red/Black	Yes
Flexsteel 250 Steam	214	-40°F to 450°F	Yes	Yes	Red/Black	Yes
Flexsteel 250 EPDM-20	215	-40°F to 450°F		Yes	Red	Yes
Heavy Duty Steam Pile Driver	213	-40°F to 406°F		Yes	Red/Black	
MIL-DTL-29210E Steam	220	0°F to 406°F		Yes	Black	
Plicord® 250 Steam	219	0°F to 406°F		Yes	Red/Black	

# Heavy Duty Steam Pile Driver



## Product Specifications

### Application

Designed to withstand the toughest off-shore pile driving applications and offer long-lasting service in on shore applications. A combination of the steam-resistant EPDM tubing plus the steel aramid construction gives this hose the pliability and kinetic and crush resistance required in this application.

### Construction Tube

Black EPDM synthetic rubber

### Cover

Red or black EPDM synthetic rubber

### Reinforcement

Brass-coated steel cord and aramid breakers

### Temperature Range

-40°F to 406°F (-40°C to 205°C)

### Packaging

100' exact length, coiled and polywrapped

### Branding (Spiral)

Example: Continental ContiTech H.D. Steam Pile Driver 250 psi WP

### Couplings

Contact fitting manufacturer for proper fitting recommendation and coupling procedure

### Order Codes

541-461 (black)

541-460 (red)

## Heavy Duty Steam Pile Driver

SAP #		ID		Nom. OD		Max. WP		Bend Radius		Weight	
Black	Red	in.	mm	in.	mm	psi	MPa	in.	mm	lb./ft.	kg/m
20196602		3	76.2	4.29	109.0	250	1.72	24	610	4.90	7.29
20252985	20214787	4	101.6	5.63	143.0	250	1.72	32	813	9.07	13.50
20525522		6	152.4	7.66	194.6	250	1.72	48	1200	10.98	16.4

**Air & Multipurpose**  
General Purpose  
Heavy Duty  
Push-on

Chemical Transfer

Cleaning Equipment

**Food**  
Transfer  
Washdown

Marine

**Material Handling**  
Abrasives  
Bulk Transfer  
Cement & Concrete

Mining

**Petroleum**  
Aircraft Fueling  
Dispensing  
Dock  
Transfer

Spray

Steam

Vacuum

LPG Delivery

**Water**  
Discharge  
Suction & Discharge  
Washdown

Welding

Coupling Systems

Equipment

Appendix

# Flexsteel® 250 Steam



## Product Specifications

### Application

For cleaning, heat control, fire prevention, pumping, thawing, blow-out service, steam pumps and hoists in open-end or permanent installation operations. It is used in refineries, shipyards, chemical plants, steel mills, foundries and heavy industrial applications where high strength is required and where severe environmental conditions are encountered.

### Construction Tube

Pyrosyn® synthetic rubber

### Cover

Black or red Pyrosyn finish, pin-pricked

### Reinforcement

Braided steel wire (3/4" and 1" have 2 steel wire braids)

### Temperature Range

-40°F to 450°F (-40°C to 232°C)

### Packaging

Reels or 50' cut lengths (1/2" - 4 per box, 3/4" - 3 per box, 1" - 2 per box)

### Branding

Example: Continental ContiTech Flexsteel® 250 Steam Max WP 250 psi. Made in U.S.A.

### Couplings

See Continental ContiTech Hose Assembly Manual for most current crimp solutions.

### Order Codes

539-070 (black)

539-076 (red)

539-470 (black wrapped)\*

539-476 (red wrapped)\*

## Flexsteel® 250 Steam

SAP #		ID		Nom. OD		Max. WP		Weight			
Black	Red	Black Wrapped	Red Wrapped	in.	mm	in.	mm	psi	MPa	lb./ft.	kg/m
20023390	20136859	20575082	20767531	1/2	12.7	1.06	26.9	250	1.72	0.45	0.67
20023401	20023462	20757055	20757277	3/4	19.1	1.28	32.5	250	1.72	0.56	0.83
20023419	20024994	20760526		1	25.4	1.63	41.4	250	1.72	0.91	1.35
		20615488	20620044	1¼	31.8	1.88	47.8	250	1.72	1.02	1.52
		20575082	20620048	1½	38.1	2.12	53.8	250	1.72	1.23	1.830
		20617154	20620060	2	50.8	2.70	68.6	250	1.72	1.79	2.66

Air & Multipurpose

General Purpose

Heavy Duty

Push-on

Chemical Transfer

Cleaning Equipment

Food

Transfer

Washdown

Marine

Material Handling

Abrasives

Bulk Transfer

Cement & Concrete

Mining

Petroleum

Aircraft Fueling

Dispensing

Dock

Transfer

Spray

Steam

Vacuum

LPG Delivery

Water

Discharge

Suction & Discharge

Washdown

Welding

Coupling Systems

Equipment

Appendix

# Flexsteel® 250 EPDM-20



## Product Specifications

### Application

The Flexsteel® 250 EPDM-20 features the superior performance of Flexsteel 250 Steam hose series enhanced with the increased safety factor of 20:1. This exceeds the RMA safety standard and makes steam operations more secure and user friendly. The hose has a maximum operating pressure of 250 psi with a temperature range of -40°F to 450°F.

### Construction Tube

Black Pyrosyn®, pin-pricked

### Cover

Red Wrapped Pyrosyn®, pin-pricked

### Reinforcement

(2) braid wire

### Temperature Range

-40°F to 450°F (-40°C to 232°C)

### Packaging

Bulk, cut lengths, coupled assemblies

### Branding (Spiral)

Example: Continental ContiTech Flexsteel® 250 EPDM-20 Steam 250 psi. Made in U.S.A.

### Couplings

See Continental ContiTech Hose Assembly Manual for most current crimp solutions.

### Order Codes

539-486

## Flexsteel® 250 EPDM-20

SAP #	ID		Nom. OD		Max. WP		Weight		
	Red	in.	mm	in.	mm	psi	MPa	lb./ft.	kg/m
20559161	3/4		19.1	1.28	32.5	250	1.72	0.59	0.83
20736602	1		25.4	1.63	41.4	250	1.72	0.95	1.43

**Air & Multipurpose**  
General Purpose  
Heavy Duty  
Push-on

Chemical Transfer

Cleaning Equipment

**Food**  
Transfer  
Washdown

Marine

**Material Handling**  
Abrasives  
Bulk Transfer  
Cement & Concrete

Mining

**Petroleum**  
Aircraft Fueling  
Dispensing  
Dock  
Transfer

Spray

**Steam**

Vacuum

LPG Delivery

**Water**  
Discharge  
Suction & Discharge  
Washdown

Welding

Coupling Systems

Equipment

Appendix

# Flexsteel® 250 CB Steam



## Product Specifications

### Application

Used for cleaning, heat control, fire prevention, pumping, thawing, blowout service, steam pumps and hoists in open-end or permanent installation operations. It is used in refineries, shipyards, chemical plants, steel mills, foundries and heavy industrial applications where high strength is required and where severe environmental conditions are encountered.

### Construction Tube

Chlorobutyl synthetic rubber

### Cover

Red or black Pyrosyn® synthetic rubber

### Reinforcement

Braided steel wire (3/4" and higher have 2 steel wire braids)

### Temperature Range

-40°F to 425°F (-40°C to 218°C)

### Packaging

Wrapped cover:

1/2" - Four 50' exact length/box

3/4"-1" - Three 50' exact length/box

1¼"-2" - One 50' exact length/box

### Branding

Example: Continental ContiTech Flexsteel® 250 CB Steam  
Max WP 250 psi. Made in U.S.A.

### Couplings

Contact fitting manufacturer for proper fitting recommendation and coupling procedure.

### Flexsteel® 250 CB Steam WF - Wrapped Finish

Order Codes: 1/2"-1" 539-176 (red)      1¼"-2" 581-176 (red)      1/2"-1" 539-170 (black)

SAP #	ID		Nom. OD		Max. WP		Weight			
	Red	Black	in.	mm	in.	mm	psi	MPa	lb./ft.	kg/m
20050829			1/2	12.7	1.00	25.4	250	1.72	0.40	0.60
20024094	20050195		3/4	19.1	1.31	33.3	250	1.72	0.64	0.95
20045991			1	25.4	1.56	39.6	250	1.72	0.77	1.15
20045770			1¼	31.8	1.75	44.5	250	1.72	1.06	1.58
20046224			1½	38.1	2.00	50.8	250	1.72	1.42	2.11
20046225			2	50.8	2.50	63.5	250	1.72	1.71	2.54

Air & Multipurpose

General Purpose

Heavy Duty

Push-on

Chemical Transfer

Cleaning Equipment

Food

Transfer

Washdown

Marine

Material Handling

Abrasives

Bulk Transfer

Cement & Concrete

Mining

Petroleum

Aircraft Fueling

Dispensing

Dock

Transfer

Spray

Steam

Vacuum

LPG Delivery

Water

Discharge

Suction & Discharge

Washdown

Welding

Coupling Systems

Equipment

Appendix



# Flexsteel® 250 CB Extreme Crimp Steam Hose



## Product Specifications

### Application

ContiTech is pleased to announce the Flexsteel® 250 CB Extreme Crimp Steam Hose, the only ContiTech chlorobutyl steam hose with an enhanced over-the-cover crimp coupling solution. The hose is rated to a maximum operating pressure of 250 psi, and its temperature range is -40°F to 425°F (-40°C to 218°C), up to 450°F intermittent, with a 10:1 safety factor. And it is the only ContiTech steam hose with a crimp solution.

### Construction Tube

Chlorobutyl synthetic rubber

### Cover

Red or black Pyrosyn®, pin-pricked

### Temperature Range

-40°F to 425°F (-40°C to 218°C), up to 450°F intermittent

### Packaging

Reels, cut lengths and coupled assemblies

### Branding

Example: Continental ContiTech Flexsteel® 250 CB Extreme Crimp Steam. Drain after using. Made in U.S.A.

### Material Code

539-870-024 (black)

539-876-024 (red)

## Flexsteel 250 CB Extreme Crimp Steam Hose

SAP #		ID		OD		Max. WP		Weight	
Black	Red	in.	mm	in.	mm	psi	MPa	lb./ft.	kg/m
20637404	20645689	3/4	19.1	1.28	32.5	0.68	1.01	250	1.72

Hose ID	Cambell Ground Joint Viton Sea Setting Low Profile Nut	Cambell Ground Joint Viton Seal Female NPT Spud Wing Nut	Cambell Male NPT	Cambell Male Male NPT Swivel	Crimp Diameter	Die Set	Approx. Setting
3/4	RGJF-3V	GJF-3V	IMS-3V	IMS-3VSW	1.43	36	0.32

Air & Multipurpose  
General Purpose  
Heavy Duty  
Push-on

Chemical Transfer

Cleaning Equipment

Food  
Transfer  
Washdown

Marine

Material Handling  
Abrasives  
Bulk Transfer  
Cement & Concrete

Mining

Petroleum  
Aircraft Fueling  
Dispensing  
Dock  
Transfer

Spray

Steam

Vacuum

LPG Delivery

Water  
Discharge  
Suction & Discharge  
Washdown

Welding

Coupling Systems

Equipment

Appendix

# Crimped Steam Assembly



## Product Specifications

### Application

Coupling assembly crimps permanently onto hose; forms a tight crimp that reduces leaks and eliminates bulky bolt clamps while reducing potential for damage from snagging on personnel or property.

### Recommended Crimp Diameters for Continental ContiTech Branded Steam Hose

Hose Description	Hose Product Code	Hose ID	Female Ground Joint Low Profile Unit	Female Ground Joint Wing Nut	Male NPT	Male NPT Swivel	Female Spud	Crimp Dia.	Continental ContiTech Perma-Crimp	Approx. Die Set	Approx. Setting
Flexsteel 250 (Black)	539-070-024	3/4"	RGJS-3V	GJS-3V	IMS-3V	IMS-3VSW	GFS-3	1.440"	34	2.6	
Flexsteel 250 (Red)	539-076-024	3/4"	RGJS-3V	GJS-3V	IMS-3V	IMS-3VSW	GFS-3	1.440"	34	2.6	
Flexsteel 250 (Black)	539-070-032	1"	RGJS-4V	GJS-4V	IMS-4V	IMS-4VSW	GFS-4	1.925"	45	3.9	
Flexsteel 250 (Red)*	539-076-032	1"	RGN-4*	GN-4*	IMS-4G*	N/A	GFS-4	1.660**	41	1.16	
Flexsteel 250 (Red Wrapped)	536-476-024	3/4"	RGJS-3V	GJS-3V	IMS-3V	IMS-3VSW	GFS-3	1.440"	34	2.6	
Flexsteel 250 CB Extreme (Black, Red)	539-870-024										
	539-876-024	3/4"	RGJF-3V	GJF-3V	IMS-3V	IMS-3VSW	GFS-3	1.430"	34	2.32	
Flexsteel 250 EPDM 20 (Red)	539-486-024	3/4"	RGJS-3V	GJS-3V	IMS-3V	IMS-3VSW	GFS-3	1.420"	34	2.1	

\*For the 2-piece skived fitting solution with SCF-4G ferrule, use GJS-4G NC stem for ground joint fittings. Skive length 1.555".

Female Wing Nut



Female Wing Nut with Female NPT Spud



Male NPT Swivel

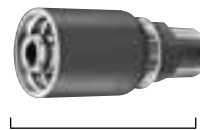

Available as Male NPT

Female Low Profile Nut with Female NPT Spud



Air & Multipurpose

General Purpose

Heavy Duty

Push-on

Chemical Transfer

Cleaning Equipment

Food

Transfer

Washdown

Marine

Material Handling

Abrasives

Bulk Transfer

Cement & Concrete

Mining

Petroleum

Aircraft Fueling

Dispensing

Dock

Transfer

Spray

Steam

Vacuum

LPG Delivery

Water

Discharge

Suction & Discharge

Washdown

Welding

Coupling Systems

Equipment

Appendix

# Plicord® 250 Steam



## Product Specifications

### Application

A rugged construction used for all-around steam service in chemical plants, refineries, shipyards and demanding industrial service. It is recommended for cleaning, thawing, blowout service, steam pumps, hoists and other applications involving steam.

### Construction Tube

Black EPDM synthetic rubber

### Cover

Black EPDM synthetic rubber, also available in red cover with yellow brand for color coding (wrapped impression)

### Reinforcement

Spiral-plied steel wire

### Temperature Range

0°F to 406°F (-18°C to 208°C)

### Packaging

50' lengths, coiled and polywrapped

### Branding (Spiral)

Example: Continental ContiTech Plicord® 250 Steam psi. Drain after use

### Couplings

Contact fitting manufacturer for proper fitting recommendation and coupling procedure.

### Order Codes

549-060 (black)  
549-061 (red)

## Plicord® 250 Steam

SAP#		ID	Nom. OD		Max. WP		Weight		
Black	Red	in.	mm	in.	mm	psi	MPa	lb./ft.	kg/m
20019132	20019162	1/2	12.7	0.97	24.6	250	1.72	0.33	0.49
20019137	20019168	3/4	19.1	1.25	31.8	250	1.72	0.49	0.73
20019141	20019174	1	25.4	1.50	38.1	250	1.72	0.61	0.91
20019144	20019178	1¼	31.8	1.81	46.0	250	1.72	0.83	1.24
20019148	20019180	1½	38.1	2.09	53.1	250	1.72	1.03	1.53
20019154	20019184	2	50.8	2.78	70.6	250	1.72	1.88	2.80
20019155	20019186	2½	63.5	3.28	83.3	250	1.72	2.33	3.47
20019158	20019187	3	76.2	3.77	95.8	250	1.72	2.73	4.06

**Air & Multipurpose**  
General Purpose  
Heavy Duty  
Push-on

Chemical Transfer

Cleaning Equipment

**Food**  
Transfer  
Washdown

Marine

**Material Handling**  
Abrasives  
Bulk Transfer  
Cement & Concrete

Mining

**Petroleum**  
Aircraft Fueling  
Dispensing  
Dock  
Transfer

Spray

Steam

Vacuum

LPG Delivery

**Water**  
Discharge  
Suction & Discharge  
Washdown

Welding

Coupling Systems

Equipment

Appendix

# MIL-DTL-29210E Steam Hose

## Updates to new “E” Specification



### Product Specifications

#### Application

Hose assembly for military applications (such as Navy shipyard use) in temporary services from docks or barges to ships. First Article-approved hose meeting the requirements of MIL-DTL-29210 rev. E. This specification covers metal-lined, wire-reinforced, rubber hose assemblies for conveyance of saturated steam.\*

Revision E update (key changes):

- ▶ Ozone and steam tests as part of conformance testing are required for 1st Article in rev. E
- ▶ Part or identifying number (PIN) is much more specific
- ▶ The branding requirements have been corrected to brand as MIL-DTL-29210 instead of MIL-PRF-29210C.

#### Construction Tube

EPDM

#### Cover

Black wrapped finish EPDM

#### Reinforcement

2 wire braids

#### Temperature Range

0° to 406°F (-18°C to 208°C)

#### Packaging

25' or 50' cut lengths

#### Branding

Continental ContiTech (Quarter/Year Date Code)  
MIL-DTL-29210 250 PSIG (1724 KPa {Gauge}) steam 29210E

#### Couplings

End fittings and special stem design per MIL-DTL-29210E for use with stainless-steel metal liner.\* Stainless-steel metal liner per MIL-DTL-29210E

#### Non Stock/Sizes

¾", 1", 1¼", 1½", 2" (\*in development)

#### Order Codes

539-670

### MIL-DTL-29210E Steam Hose

SAP #	ID		Nom. OD		Max. WP		Weight	
	in.	mm	in.	mm	psi	MPa	lb./ft.	kg/m
20490435	3/4	19.05	1.315	33.40	250	1.723	0.61	0.91
20453479	1	25.4	1.61	40.89	250	1.723	0.82	1.22
20469264	1½	38.1	2.12	53.85	250	1.723	1.22	1.82
20458670	2	50.8	2.71	68.83	250	1.723	1.80	2.68

\*Steel liners are not available through Continental ContiTech. Please refer to Mil Spec for approved suppliers list.

Air & Multipurpose  
General Purpose  
Heavy Duty  
Push-on

Chemical Transfer

Cleaning Equipment

Food  
Transfer  
Washdown

Marine

Material Handling  
Abrasives  
Bulk Transfer  
Cement & Concrete

Mining

Petroleum  
Aircraft Fueling  
Dispensing  
Dock  
Transfer

Spray

Steam

Vacuum

LPG Delivery

Water  
Discharge  
Suction & Discharge  
Washdown

Welding

Coupling Systems

Equipment

Appendix

# Vacuum



	Page	Rubber	Thermoplastic	Clear	Corrugated Cover	Lightweight	Temp. Range
Arvac SW	110		Yes		Yes	Yes	-40°F to 158°F
Plicord HD Industrial Vacuum	225	Yes			Yes		-40°F to 180°F
Plicord Vacuum (HD & LW)	226	Yes			Yes	Yes	-25°F to 180°F
Spiraflex Ducting	223		Yes		Yes	Yes	0°F to 150°F
Spiraflex Grassvac	222		Yes	Yes	Yes	Yes	0°F to 158°F
Spiraflex Vacuum	224		Yes		Yes	Yes	0°F to 158°F
Spirathane HD	121		Yes		Yes	Yes	0°F to 158°F
Spirathane LD	123		Yes	Yes	Yes	Yes	0°F to 158°F
Spirathane PT	122		Yes	Yes	Yes	Yes	0°F to 158°F

**Air & Multipurpose**  
 General Purpose  
 Heavy Duty  
 Push-on

Chemical Transfer

Cleaning Equipment

**Food**  
 Transfer  
 Washdown

Marine

**Material Handling**  
 Abrasives  
 Bulk Transfer  
 Cement & Concrete

Mining

**Petroleum**  
 Aircraft Fueling  
 Dispensing  
 Dock  
 Transfer

Spray

Steam

**Vacuum**

LPG Delivery

**Water**  
 Discharge  
 Suction & Discharge  
 Washdown

Welding

Coupling Systems

Equipment

Appendix

# Spiraflex® Grassvac™



## Product Specifications

### Application

For lawn, leaf, mulch and yard waste collection. It is also suitable for dust control, ventilation and ducting.

### Couplings

Contact fitting manufacturer for proper fitting recommendation and coupling procedure.

### Construction Tube

Clear Pliovic®

### Non Stock/Sizes

Available in all black construction.

### Reinforcement

Black rigid, high-density Pliovic helix

### Order Codes

586-429 (clear web, black helix)

### Temperature Range

0°F to 158°F (-18°C to 70°C)

### Packaging

4-6' - 100' lengths, coiled and polywrapped  
7-8' - 50' lengths, coiled and polywrapped

### Branding

Not branded

## Spiraflex® Grassvac™

SAP #	ID		Nom. OD		Max. WP		Bend Radius		Vacuum HG		Weight		
	Black	in.	mm	in.	mm	psi	MPa	in.	mm	in.	mm	lb./ft.	kg/m
20013384	4		101.6	4.46	113.3	15	0.10	4	102	15	381	0.71	1.06
20013385	5		127.0	5.55	141.0	15	0.10	7	178	15	381	1.07	1.59
20013388	6		152.4	6.56	166.6	10	0.07	7	178	15	381	1.43	2.13
20131290	7		177.8	7.63	193.8	10	0.07	9	229	15	381	1.75	2.60
20013390	8		203.2	8.66	220.0	10	0.07	9	229	15	381	2.06	3.07

Air & Multipurpose  
General Purpose  
Heavy Duty  
Push-on

Chemical Transfer

Cleaning Equipment

Food  
Transfer  
Washdown

Marine

Material Handling  
Abrasives  
Bulk Transfer  
Cement & Concrete

Mining

Petroleum  
Aircraft Fueling  
Dispensing  
Dock  
Transfer

Spray

Steam

Vacuum

LPG Delivery

Water  
Discharge  
Suction & Discharge  
Washdown

Welding

Coupling Systems

Equipment

Appendix

# Spiraflex® Ducting



## Product Specifications

### Application

Versatile enough for use in leaf collection machines, manhole blowers and air conditioning and heating applications, as well as for air ducting and pollution control devices. Do not use Spiraflex® Ducting for pressure service.

### Construction Tube

Metallic green Pliovic® synthetic compound

### Reinforcement

Rigid white high-density Pliovic® helix

### Temperature Range

0°F to 150°F (-18°C to 66°C)

### Packaging

1"-6" - 100' lengths, coiled and polywrapped  
8" - 30' lengths, polywrapped

### Branding

Not branded

### Couplings

Contact fitting manufacturer for proper fitting recommendation and coupling procedure.

### Order Codes

586-408

## Spiraflex® Ducting

SAP #	ID		Nom. OD		Max. WP		Bend Radius		Weight	
	in.	mm	in.	mm	psi	MPa	in.	mm	lb./ft.	kg/m
20013152	1	25.4	1.21	30.7	2	33	5	127	0.13	0.19
20013153	1¼	31.8	1.50	38.1	2	51	5	127	0.18	0.27
20013157	1½	38.1	1.74	44.2	2	57	5	127	0.22	0.33
20013158	2	50.8	2.30	58.4	3	76	5	127	0.28	0.42
20013159	2½	63.5	2.80	71.1	4	102	5	127	0.31	0.46
20013160	3	76.2	3.40	86.4	7	160	5	127	0.53	0.79
20013161	4	101.6	4.44	112.8	8	191	5	127	0.60	0.89
20013162	5	127.0	5.50	139.7	9	229	5	127	0.90	1.34
20013168	6	152.4	6.46	164.1	10	254	5	127	1.04	1.55
20013170	8	203.2	8.52	216.4	12	305	5	127	1.60	2.38

**Air & Multipurpose**  
General Purpose  
Heavy Duty  
Push-on

Chemical Transfer

Cleaning Equipment

**Food**  
Transfer  
Washdown

Marine

**Material Handling**  
Abrasives  
Bulk Transfer  
Cement & Concrete

Mining

**Petroleum**  
Aircraft Fueling  
Dispensing  
Dock  
Transfer

Spray

Steam

**Vacuum**

LPG Delivery

**Water**  
Discharge  
Suction & Discharge  
Washdown

Welding

Coupling Systems

Equipment

Appendix

# Spiraflex® Vacuum



## Product Specifications

### Application

Spiraflex® Vacuum hose is for dust collection and exhaust transmission where airborne pollutants, fumes and odors are a major problem.

### Construction Tube

White Pliovic® compound

### Reinforcement

Rigid white high-density Pliovic® helix

### Temperature Range

0°F to 158°F (-18°C to 70°C)

### Packaging

1"-4" - 100' lengths, coiled and polywrapped

5"-6" - 30' lengths, coiled and polywrapped

### Branding

Not branded

### Couplings

Contact fitting manufacturer for proper fitting recommendation and coupling procedure.

### Order Codes

586-403

## Spiraflex® Vacuum

SAP #	ID	Nom. OD		Max. WP		Bend Radius		Vacuum HG		Weight		
White	in.	mm	in.	mm	psi	MPa	in.	mm	in.	mm	lb./ft.	kg/m
20013089	1	25.4	1.22	31.0	37	0.26	3	64	29	737	0.13	0.19
20013090	1¼	31.8	1.50	38.1	37	0.26	4	84	29	737	0.24	0.36
20013092	1½	38.1	1.76	44.7	34	0.23	4	97	29	737	0.29	0.43
20013094	2	50.8	2.35	59.7	30	0.21	6	140	29	737	0.45	0.67
20013095	2½	63.5	2.87	72.9	30	0.21	7	178	29	737	0.61	0.91
20013096	3	76.2	3.42	86.9	30	0.21	8	203	29	737	0.80	1.19
20013097	4	101.6	4.53	115.1	27	0.19	14	356	15	381	1.13	1.68
20220897	5	127.0	5.50	139.7	25	0.17	20	508	10	254	1.07	1.59
20013099	6	152.4	6.59	167.4	20	0.14	25	635	10	254	2.05	3.05

Air & Multipurpose

General Purpose

Heavy Duty

Push-on

Chemical Transfer

Cleaning Equipment

Food

Transfer

Washdown

Marine

Material Handling

Abrasives

Bulk Transfer

Cement & Concrete

Mining

Petroleum

Aircraft Fueling

Dispensing

Dock

Transfer

Spray

Steam

Vacuum

LPG Delivery

Water

Discharge

Suction & Discharge

Washdown

Welding

Coupling Systems

Equipment

Appendix



# Plicord® HD Industrial Vacuum



## Product Specifications

### Application

For handling exhaust acid fumes as well as abrasive dust from metal, rock, marble and wood grinding machines.

### Construction Tube

3/16" Gauge Tan Pureten™ rubber

### Cover

Black SBR synthetic rubber (corrugated)

### Reinforcement

Spiral-plied synthetic fabric with double wire helix

### Temperature Range

-40°F to 180°F (-40°C to 82°C)

### Packaging

Polywrapped

### Branding (Spiral)

Example: Continental ConitTech Made in Canada

### Couplings

Contact fitting manufacturer for proper fitting recommendation and coupling procedure.

### Non Stock/Sizes

Custom lengths available. Available with Black Pureten™

### Order Codes

Tan Pureten:  
549-222 (2"-6<sup>5</sup>/<sub>8</sub>")  
541-222 (7"-12<sup>3</sup>/<sub>4</sub>")

## Plicord® HD Industrial Vacuum

SAP #	ID		Nom. OD		Max. WP		Bend Radius		Vacuum HG		Weight	
	in.	mm	in.	mm	psi	MPa	in.	mm	in.	mm	lb./ft.	kg/m
20140398	2 <sup>3</sup> / <sub>8</sub>	69.9	3.04	77.2	75	0.52	7	178	29	737	1.51	2.25
20015119	3 <sup>1</sup> / <sub>2</sub>	88.9	4.28	108.7	50	0.34	11	279	29	737	2.63	3.91
20745648	4	101.6	4.76	120.9	50	0.34	12	305	29	737	3.11	4.63
20270756	4 <sup>1</sup> / <sub>2</sub>	114.3	5.26	133.6	50	0.34	14	356	29	737	3.45	5.13
20251005	5	127.0	5.80	147.3	35	0.24	15	381	29	737	4.29	6.38
20140308	6	152.4	6.80	172.7	35	0.24	18	457	29	737	5.07	7.54
20368104	6 <sup>5</sup> / <sub>8</sub>	168.3	7.44	189.0	35	0.24	20	508	29	737	5.78	8.60
20015124	7	177.8	7.81	198.4	35	0.24	21	533	29	737	6.08	9.06
20313490	8	203.2	8.87	225.3	35	0.24	24	610	29	737	7.29	10.86
20540957	8 <sup>5</sup> / <sub>8</sub>	219.1	9.48	240.8	35	0.24	26	660	29	737	8.39	12.50
20142810	10	254.0	10.87	276.1	35	0.24	32	813	29	737	9.67	14.41
20320681	12	304.8	12.91	327.9	35	0.24	39	991	29	737	11.81	17.60
20015131	12 <sup>3</sup> / <sub>4</sub>	323.8	13.69	347.7	35	0.24	39	991	29	737	12.69	18.91

**Air & Multipurpose**  
General Purpose  
Heavy Duty  
Push-on

Chemical Transfer

Cleaning Equipment

**Food**  
Transfer  
Washdown

Marine

**Material Handling**  
Abrasives  
Bulk Transfer  
Cement & Concrete

Mining

**Petroleum**  
Aircraft Fueling  
Dispensing  
Dock  
Transfer

Spray

Steam

**Vacuum**

LPG Delivery

**Water**  
Discharge  
Suction & Discharge  
Washdown

Welding

Coupling Systems

Equipment

Appendix

# Plicord® Vacuum



## Product Specifications

### Application

Heavy-duty construction for handling abrasive particles from metal, rock and marble grinding machines under vacuum. Lightweight construction used to exhaust fumes and abrasive dust from woodworking machines, metal, rock, granite and similar processing equipment

### Temperature Range

-25°F to 180°F (-32°C to 82°C)

### Branding (Spiral)

Example: Continental ContiTech Plicord® HD Vacuum

### Couplings

Contact fitting manufacturer for proper fitting recommendation and coupling procedure.

### Construction Tube

Black ChemiTuf® synthetic rubber (static dissipating/static conductive)

### Cover

Black SBR synthetic rubber (corrugated)

### Reinforcement

Spiral-plied synthetic fabric with wire helix

### Plicord® HD Industrial Vacuum

Order Codes: 549-208 (6" and below) 541-208 (8" ID)

SAP #	ID	Nom. OD		Bend Radius		Vacuum HG		Weight		
		in.	mm	in.	mm	psi	MPa	lb./ft.	kg/m	
20019382	1½	38.1	1.95	49.5	29	737	6	152	0.77	1.15
20019384	2	50.8	2.46	62.5	29	737	8	203	0.95	1.41
20019385	3	76.2	3.70	94.0	29	737	12	305	2.25	3.35
20019386	4	101.6	4.79	121.7	29	737	16	406	3.34	4.97
20019387	6	152.4	6.80	172.7	29	737	36	914	5.10	7.59
20015105	8	203.2	9.20	233.7	29	737	48	1219	7.53	11.21

### Plicord® LW Industrial Vacuum (Lightweight Construction)

Order Codes: 549-207

SAP #	ID	Nom. OD		Bend Radius		Vacuum HG		Weight		
		in.	mm	in.	mm	psi	MPa	lb./ft.	kg/m	
20019375	1½	38.1	1.82	46.2	29	737	6	152	0.59	0.88
20019378	2	50.8	2.33	59.2	29	737	8	203	0.70	1.04
20019379	3	76.2	3.33	84.6	29	737	12	305	1.15	1.71
20019380	4	101.6	4.93	125.2	29	737	16	406	1.85	2.75

# LPG Delivery



	Page
LPG Delivery Pro	228

**Air & Multipurpose**  
 General Purpose  
 Heavy Duty  
 Push-on

Chemical Transfer

Cleaning Equipment

**Food**  
 Transfer  
 Washdown

Marine

**Material Handling**  
 Abrasives  
 Bulk Transfer  
 Cement & Concrete

Mining

**Petroleum**  
 Aircraft Fueling  
 Dispensing  
 Dock  
 Transfer

Spray

Steam

Vacuum

LPG Delivery

**Water**  
 Discharge  
 Suction & Discharge  
 Washdown

Welding

Coupling Systems

Equipment

Appendix

# LPG Delivery Pro™



## Product Specifications

### Application

LPG Delivery Pro™ is for residential and commercial delivery/transfer of liquid propane gas - the only UL listed LPG bobtail transfer assembly in the market. Excellent cold weather flexibility, a smooth cover for low drag resistance and low tube extraction to reduce contamination.

**Not for LP appliances or other consumer applications.**

### Construction Tube

Nitrile

### Cover

Synthetic rubber

### Reinforcement

1" and 2" Textile braid, Spiral Reinforced000000

### Temperature Range

-40°F to 180°F (-40°C to 82°C)

### Packaging

Available in coupled assemblies only

### Branding

Example: 1" (25.4mm) LPG Delivery Pro™ CGA Type 1 LPG-Hose Issue No. E-8167 350 psi (2.4 MPa) Max WP. Made in U.S.A.

### Couplings

Factory installed crimped fittings only

### Order Codes

581-412

**LPG Delivery Pro™** 20710255 (1" x 100'), 20458415 (1" x 125'), 20458416 (1" x 150'), 20708132 (1" x 175')

ID		Nom. OD		Max. WP		Weight	
in.	mm	in.	mm	psi	MPa	lb./ft.	kg/m
1	25.4	1.490	37.8	350	2.41	0.57	0.85

#### Air & Multipurpose

General Purpose

Heavy Duty

Push-on

Chemical Transfer

Cleaning Equipment

Food

Transfer

Washdown

Marine

Material Handling

Abrasives

Bulk Transfer

Cement & Concrete

Mining

Petroleum

Aircraft Fueling

Dispensing

Dock

Transfer

Spray

Steam

Vacuum

LPG Delivery

Water

Discharge

Suction & Discharge

Washdown

Welding

Coupling Systems

Equipment

Appendix

# Water Discharge



	Page	Rubber	Thermoplastic	MSHA	Temp. Range	Coupled Lengths	Lay-flat Construction
Brigade Mine	142		Yes	Yes	-10°F to 150°F (-23°C to 66°C)		Yes
Fire Engine Booster	235	Yes			0°F to 180°F (-18°C to 82°C)	Yes	
Pathfinder Garden Hose	236	Yes			-40°F to 190°F (-40°C to 88°C)	Yes	
Plicord Furnace Door	237	Yes			-25°F to 200°F (-32°C to 93°C)		
Plicord HD Water Discharge	238	Yes			-25°F to 180°F (-32°C to 82°C)		
Prospector Water 150	239	Yes			-25°F to 180°F (-32°C to 82°C)		
Potable Water	78	Yes			-25°F to 180°F (-32°C to 82°C)		
Spiraflex Black (Lay-Flat Super Duty)	230	Yes			-36°F to 178°F (-38°C to 81°C)		Yes
Spiraflex Blue (Extra Light Duty)	231		Yes		-10°F to 150°F (-23°C to 66°C)		Yes
Spiraflex Gray (Light Duty)	232		Yes		-10°F to 150°F (-23°C to 66°C)		Yes
Spiraflex Red (Medium Duty)	233		Yes	Yes	-10°F to 150°F (-23°C to 66°C)		Yes
Spiraflex Yellow (Heavy Duty)	234		Yes		-10°F to 150°F (-23°C to 66°C)		Yes

**Air & Multipurpose**  
General Purpose  
Heavy Duty  
Push-on

Chemical Transfer

Cleaning Equipment

**Food**  
Transfer  
Washdown

Marine

**Material Handling**  
Abrasives  
Bulk Transfer  
Cement & Concrete

Mining

**Petroleum**  
Aircraft Fueling  
Dispensing  
Dock  
Transfer

Spray

Steam

Vacuum

LPG Delivery

**Water**  
Discharge  
Suction & Discharge  
Washdown

Welding

Coupling Systems

Equipment

Appendix

# Spiraflex® Black Lay-Flat Super Duty Hose



## Product Specifications

### Application

Spiraflex® Black is a lay-flat, heavy-duty water discharge and washdown hose that combines the lightweight, compact features of PVC with the durability and abrasion resistance of conventional construction. This hose features a unique one-piece, through-the-weave construction and attains its working pressure from a synthetic woven textile. Resists mildew/rot and requires no drying time. Its excellent durability is derived from a high-tensile rubber compound, which completely encases the jacket. Applications include irrigation, washdown, dewatering, coal preparation and utility plants; gas drilling; jetting and pump discharge; storage tank cleaning and sewer cleaning.

### Construction Tube and Cover

Nitrile/PVC compound. Both tube and cover are simultaneously extruded to obtain maximum bending.

### Reinforcement

Through-the-weave fabric reinforcement

### Temperature Range

-36°F to 178°F (-37°C to 81°C)

### Packaging

Coiled

### Branding

Not branded

### Couplings

Contact your Continental ContiTech representative for special production run minimum requirements.

### Order Codes

Contact Customer Service for ordering details

## Spiraflex® Black Lay-Flat Super Duty Hose

SAP #	ID		Nom. OD		Max. WP		Weight	
	in.	mm	in.	mm	psi	MPa	lb./ft.	kg/m
20466096	1½	38.09	1.58	40.13	300	1.72	0.26	0.38
20466081	2	50.80	2.08	52.83	250	1.72	0.36	0.54
20466020	2½	63.50	2.58	65.53	250	1.72	0.46	0.68
20466098	3	76.19	3.10	78.74	230	1.72	0.52	0.77
20466047	4	101.60	4.10	104.14	200	1.38	0.72	1.07
20466364	6	152.39	6.13	155.70	150	1.03	1.25	1.86
20466752	8	203.20	8.16	207.26	150	1.03	1.70	2.53

Air &amp; Multipurpose

General Purpose

Heavy Duty

Push-on

Chemical Transfer

Cleaning Equipment

Food

Transfer

Washdown

Marine

Material Handling

Abrasives

Bulk Transfer

Cement &amp; Concrete

Mining

Petroleum

Aircraft Fueling

Dispensing

Dock

Transfer

Spray

Steam

Vacuum

LPG Delivery

Water

Discharge

Suction &amp; Discharge

Washdown

Welding

Coupling Systems

Equipment

Appendix

# Spiraflex® Blue Extra Light Duty



## Product Specifications

### Application

For light-duty water discharge applications in mining, construction, industry, agricultural and marine service.

### Construction Tube

Blue PVC compound

### Cover

Blue PVC compound

### Reinforcement

Synthetic fabric

### Temperature Range

-10°F to 150°F (-23°C to 66°C)

### Packaging

300'; continuous one piece, coiled and polywrapped

### Branding

Example: Continental ContiTech Spiraflex® Blue 2" (50.8 mm) 80 psi WP (.55 MPa)

### Couplings

Contact fitting manufacturer for proper fitting recommendation and coupling procedure.

### Order Codes

537-564

## Spiraflex® Blue Extra Light Duty

SAP #	ID		Nom. OD		Max. WP		Weight	
	in.	mm	in.	mm	psi	MPa	lb./ft.	kg/m
20069152	1½	38.1	1.67	42.4	90	0.62	0.18	0.27
20069153	2	50.8	2.21	56.1	80	0.55	0.24	0.37
20069210	2½	63.5	2.68	68.1	55	0.38	0.35	0.52
20069213	3	76.2	3.20	81.3	55	0.38	0.38	0.56
20069216	4	101.6	4.26	108.2	50	0.34	0.63	0.94
20069219	6	152.4	6.26	159.0	35	0.24	1.14	1.70
20069222	8	203.2	8.32	211.3	35	0.24	1.30	1.93

Note: Working pressures are rated at 72°F (22°C).

**Air & Multipurpose**  
General Purpose  
Heavy Duty  
Push-on

Chemical Transfer

Cleaning Equipment

**Food**  
Transfer  
Washdown

Marine

**Material Handling**  
Abrasives  
Bulk Transfer  
Cement & Concrete

Mining

**Petroleum**  
Aircraft Fueling  
Dispensing  
Dock  
Transfer

Spray

Steam

Vacuum

LPG Delivery

**Water**  
Discharge  
Suction & Discharge  
Washdown

Welding

Coupling Systems

Equipment

Appendix

# Spiraflex® Gray Light Duty



## Product Specifications

### Application

For light-duty water discharge service.

### Construction Tube

Black Pliovic® compound

### Cover

Gray Pliovic compound

### Reinforcement

Synthetic fabric

### Temperature Range

-10°F to 150°F (-23°C to 66°C)

### Packaging

300' continuous one piece, coiled and banded

### Branding

Example: Continental ContiTech Spiraflex® Gray 2" (50.8 mm) 80 psi (.55 MPa). Made in U.S.A.

### Couplings

Contact fitting manufacturer for proper fitting recommendation and coupling procedure.

### Order Codes

537-555

## Spiraflex® Gray Light Duty

SAP #	ID		Nom. OD		Max. WP		Weight	
	in.	mm	in.	mm	psi	MPa	lb./ft.	kg/m
20012556	1½	38.1	1.72	43.7	90	0.62	0.18	0.27
20012562	2	50.8	2.22	56.4	80	0.55	0.24	0.35
20012567	2½	63.5	2.79	70.9	60	0.41	0.35	0.52
20012572	3	76.2	3.27	83.1	50	0.34	0.38	0.57
20012576	4	101.6	4.33	110.0	45	0.31	0.63	1.01
20012580	6	152.4	6.38	162.1	35	0.24	1.14	1.70

Note: Working pressures are rated at 72°F (22°C).

**Air & Multipurpose**

- General Purpose
- Heavy Duty
- Push-on

Chemical Transfer

Cleaning Equipment

**Food**

- Transfer
- Washdown

Marine

**Material Handling**

- Abrasives
- Bulk Transfer
- Cement & Concrete

Mining

**Petroleum**

- Aircraft Fueling
- Dispensing
- Dock Transfer

Spray

Steam

Vacuum

LPG Delivery

**Water**

- Discharge
- Suction & Discharge
- Washdown

Welding

Coupling Systems

Equipment

Appendix



# Spiraflex® Red Medium Duty



## Product Specifications

### Application

For medium-duty discharge applications in mining, construction, industry, agriculture and marine service. Limited oil and chemical application.

### Construction Tube

Black Pliovic® /Nitrile rubber tube

### Cover

Red Pliovic, MSHA 2G-14C/16

### Reinforcement

Spiral synthetic yarn, one layer longitudinal synthetic yarn

### Temperature Range

-10°F to 150°F (-23°C to 66°C)

### Packaging

300' continuous one piece, coiled and banded

### Branding

Example: Continental ContiTech Spiraflex® Red 2" (50.8 mm) 150 psi WP (1.03 MPa), Flame Resistant, USMSHA 2G-14C/16. Made in U.S.A.

### Couplings

Contact fitting manufacturer for proper fitting recommendation and coupling procedure.

### Order Codes

537-521

## Spiraflex® Red Medium Duty

SAP #	ID		Nom. OD		Max. WP		Weight	
	in.	mm	in.	mm	psi	MPa	lb./ft.	kg/m
20012500	1½	38.1	1.71	43.4	150	1.03	0.23	0.34
20012501	2	50.8	2.24	56.9	150	1.03	0.36	0.54
20012502	2½	63.5	2.79	70.9	150	1.03	0.41	0.61
20012503	3	76.2	3.29	83.6	125	0.86	0.46	0.68
20012504	4	101.6	4.32	109.7	100	0.69	0.73	1.09
20012505	6	152.4	6.40	162.6	100	0.69	1.18	1.76

Note: Working pressures are rated at 72°F (22°C).

**Air & Multipurpose**  
General Purpose  
Heavy Duty  
Push-on

Chemical Transfer

Cleaning Equipment

**Food**  
Transfer  
Washdown

Marine

**Material Handling**  
Abrasives  
Bulk Transfer  
Cement & Concrete

Mining

**Petroleum**  
Aircraft Fueling  
Dispensing  
Dock  
Transfer

Spray

Steam

Vacuum

LPG Delivery

**Water**  
Discharge  
Suction & Discharge  
Washdown

Welding

Coupling Systems

Equipment

Appendix

# Spiraflex® Yellow Heavy Duty Spiraflex® 2700



## Product Specifications

### Application

For heavy-duty applications in mining, agriculture, construction and marine service. Limited oil and chemical application.

### Construction Tube

Black Pliovic® /Nitrile PVC Tube

### Cover

Yellow fire-retardant Pliovic, MSHA 2G-14C/15

### Reinforcement

Synthetic fabric

### Temperature Range

-10°F to 150°F (-23°C to 66°C)

### Packaging

300' continuous one-piece, coiled and banded

### Branding

Example: Continental ContiTech Spiraflex® Yellow 2" (50.8 mm), 200 psi (1.38 MPa) Flame Resistant, USMSHA 2G-14C/15. Made in U.S.A.

### Couplings

Contact fitting manufacturer for proper fitting recommendation and coupling procedure.

### Order Codes

537-513

## Spiraflex® Yellow Heavy Duty

SAP #	ID		Nom. OD		Max. WP		Weight	
	in.	mm	in.	mm	psi	MPa	lb./ft.	kg/m
20012467	1½	38.1	1.77	45.0	200	1.38	0.32	0.48
20012469	2	50.8	2.34	59.4	200	1.38	0.42	0.63
20012470	2½	63.5	2.88	73.2	200	1.38	0.66	0.98
20012472	3	76.2	3.40	86.4	200	1.38	0.76	1.13
20012475	4	101.6	4.41	112.0	150	1.03	1.00	1.49
20012480	6	152.4	6.48	164.6	150	1.03	1.69	2.51

Note: Working pressures are rated at 72°F.

Air & Multipurpose  
General Purpose  
Heavy Duty  
Push-on

Chemical Transfer

Cleaning Equipment

Food  
Transfer  
Washdown

Marine

Material Handling  
Abrasives  
Bulk Transfer  
Cement & Concrete

Mining

Petroleum  
Aircraft Fueling  
Dispensing  
Dock  
Transfer

Spray

Steam

Vacuum

LPG Delivery

**Water**  
Discharge  
Suction & Discharge  
Washdown

Welding

Coupling Systems

Equipment

Appendix

# Fire Engine Booster



## Product Specifications

### Application

For use in high-pressure fire engine booster service. Also has many applications in other heavy-duty industrial and municipal operations.

### Construction Tube

Synthetic rubber

### Cover

Red synthetic rubber

### Reinforcement

Braided (2) synthetic yarn

### Temperature Range

0°F to 180°F (-18°C to 82°C)

### Packaging

Cartons: 1000' (50' increments)

Cut lengths: 50' (2 pieces); 100' (1 piece)

Coupled lengths: 50' (2 pieces); 100' (1 piece)

### Branding

Example: Continental ContiTech 1" Fire Engine Booster. Made in U.S.A.

### Couplings

Contact fitting manufacturer for proper fitting recommendation and coupling procedure.

### Order Codes

536-382

## Fire Engine Booster

SAP #	ID		Nom. OD		Max. WP		Weight	
	in.	mm	in.	mm	psi	MPa	lb./ft.	kg/m
20023056	3/4	19.1	1.25	31.8	800	5.52	0.42	0.62
20023068	1	25.4	1.53	38.9	800	5.52	0.57	0.85

**Air & Multipurpose**  
General Purpose  
Heavy Duty  
Push-on

Chemical Transfer

Cleaning Equipment

**Food**  
Transfer  
Washdown

Marine

**Material Handling**  
Abrasives  
Bulk Transfer  
Cement & Concrete

Mining

**Petroleum**  
Aircraft Fueling  
Dispensing  
Dock  
Transfer

Spray

Steam

Vacuum

LPG Delivery

**Water**  
Discharge  
Suction & Discharge  
Washdown

Welding

Coupling Systems

Equipment

Appendix

# Pathfinder® Garden Hose



## Product Specifications

### Application

For in-home, lawn and garden, apartment, smaller plant and commercial property applications.

### Construction Tube

EPDM synthetic rubber

### Cover

Green EPDM synthetic rubber

### Reinforcement

Spiral synthetic yarn

### Temperature Range

-40°F to 190°F (-40°C to 88°C)

### Packaging

500' reels, maximum 3 pieces, 50' increments

### Branding

Example: 5/8" (15.9mm) Pathfinder® Continental ContiTech 100 psi WP

### Couplings

Contact fitting manufacturer for proper fitting recommendation and coupling procedure.

### Non-Stock/Sizes

Available in 25' or 50' coupled assemblies.

### Order Codes

569-027

## Pathfinder® Garden Hose

SAP #	ID		Nom. OD		Max. WP		Weight	
	in.	mm	in.	mm	psi	MPa	lb./ft.	kg/m
20026213	5/8	15.9	0.94	23.9	100	0.69	0.22	0.33

**Air & Multipurpose**

- General Purpose
- Heavy Duty
- Push-on

Chemical Transfer

Cleaning Equipment

- Food Transfer
- Washdown

Marine

**Material Handling**

- Abrasives
- Bulk Transfer
- Cement & Concrete

Mining

**Petroleum**

- Aircraft Fueling
- Dispensing
- Dock Transfer

Spray

Steam

Vacuum

LPG Delivery

**Water**

- Discharge
- Suction & Discharge
- Washdown

Welding

Coupling Systems

Equipment

Appendix

# Plicord® Furnace Door



## Product Specifications

### Application

For carrying cooling water to furnace doors in steel mills and similar service operations where the outside of the hose is subjected to open flame and elevated temperatures.

### Construction Tube

SBR synthetic rubber (non-conductive)

### Cover

Fiberglass fabric ply over rubber cover

### Reinforcement

Spiral-plied (4) plies of synthetic fabric

### Temperature Range

-25°F to 200°F (-32°C to 93°C)

### Packaging

1/2"-4" - 100' lengths, coiled and polywrapped

### Branding

Not branded

### Couplings

Contact fitting manufacturer for proper fitting recommendation and coupling procedure.

### Order Codes

542-309

## Plicord® Furnace Door

SAP #	ID		Nom. OD		Max. WP		Weight	
	in.	mm	in.	mm	psi	MPa	lb./ft.	kg/m
20016515	1/2	12.7	1.06	26.9	200	1.38	0.38	0.57
20016518	3/4	19.1	1.32	33.5	200	1.38	0.52	0.77
20016522	1	25.4	1.64	41.7	200	1.38	0.76	1.13
20018362	1¼	31.8	2.06	52.3	200	1.38	1.19	1.77
20016527	1½	38.1	2.30	58.4	200	1.38	1.36	2.02
20016530	2	50.8	2.87	72.9	200	1.38	1.85	2.75
20069910	2½	63.5	3.36	85.3	200	1.38	2.23	3.32
20187448	4	102.0	4.87	123.8	150	1.03	6.90	10.30

**Air & Multipurpose**  
General Purpose  
Heavy Duty  
Push-on

Chemical Transfer

Cleaning Equipment

**Food**  
Transfer  
Washdown

Marine

**Material Handling**  
Abrasives  
Bulk Transfer  
Cement & Concrete

Mining

**Petroleum**  
Aircraft Fueling  
Dispensing  
Dock  
Transfer

Spray

Steam

Vacuum

LPG Delivery

**Water**  
Discharge  
Suction & Discharge  
Washdown

Welding

Coupling Systems

Equipment

Appendix

# Plicord® HD Water Discharge



## Product Specifications

### Application

A heavy-duty, all-purpose hose with excellent abrasion resistance. It is ideal for service in quarries, mines and construction.

### Construction Tube

Black SBR synthetic rubber

### Cover

Black SBR synthetic rubber (wrapped finish)

### Reinforcement

Spiral-plied (4) plies of synthetic fabric

### Temperature Range

-25°F to 180°F (-32°C to 82°C)

### Packaging

1"-8" - 100' lengths, coiled and polywrapped

### Branding (Spiral)

Example: Continental ContiTech Plicord® HD Water

### Couplings

Contact fitting manufacturer for proper fitting recommendation and coupling procedure.

### Order Codes

542-437 (65/8" and below)

541-437 (8" and above)

## Plicord® HD Water Discharge

SAP #	ID		Nom. OD		Max. WP		Weight	
	in.	mm	in.	mm	psi	MPa	lb./ft.	kg/m
20016585	1½	38.1	2.00	50.8	200	1.38	0.79	1.18
20016592	2	50.8	2.50	63.5	200	1.38	0.97	1.44
20016598	2½	63.5	3.06	77.7	200	1.38	1.36	2.02
20016602	3	76.2	3.55	90.2	200	1.38	1.60	2.38
20016608	4	101.6	4.58	116.3	150	1.03	2.10	3.13
20016613	4½	114.3	5.07	128.8	150	1.03	2.34	3.48
20016614	5	127.0	5.57	141.5	150	1.03	2.59	3.85
20016618	6	152.4	6.53	165.9	150	1.03	2.87	4.27
20015553	6¾	168.3	7.22	183.4	150	1.03	3.58	5.33
20015559	8	203.2	8.57	217.7	100	0.69	4.06	6.04
20620155	8¾	219.1	9.19	233.4	100	0.69	4.57	6.81
20015561	10	254.0	10.63	270.0	100	0.69	5.73	8.54
20015564	12	304.8	12.66	321.6	100	0.69	6.79	10.12

Air & Multipurpose

General Purpose

Heavy Duty

Push-on

Chemical Transfer

Cleaning Equipment

Food

Transfer

Washdown

Marine

Material Handling

Abrasives

Bulk Transfer

Cement & Concrete

Mining

Petroleum

Aircraft Fueling

Dispensing

Dock

Transfer

Spray

Steam

Vacuum

LPG Delivery

Water

Discharge

Suction & Discharge

Washdown

Welding

Coupling Systems

Equipment

Appendix

# Prospector™ Water 150



## Product Specifications

### Application

For use in heavy-duty service for a wide range of applications.

### Construction Tube

Black SBR synthetic rubber

### Cover

Black SBR synthetic rubber

### Reinforcement

Spiral-plied synthetic fabric

### Temperature Range

-25°F to 180°F (-32°C to 82°C)

### Packaging

3/4"-6" - 100' lengths, coiled and polywrapped

### Branding (Spiral)

Example: Continental ContiTech Plicord® Water 150

### Couplings

Contact fitting manufacturer for proper fitting recommendation and coupling procedure.

### Order Codes

542-439 (1/2"-6")

## Prospector™ Water 150

SAP #	ID		Nom. OD		Max. WP		Weight	
	in.	mm	in.	mm	psi	MPa	lb./ft.	kg/m
20016664	3/4	19.1	1.04	26.4	150	1.03	0.23	0.34
20016665	1	25.4	1.29	32.8	150	1.03	0.30	0.45
20016666	1¼	31.8	1.60	40.6	150	1.03	0.43	0.64
20016669	1½	38.1	1.84	46.7	150	1.03	0.50	0.74
20016673	2	50.8	2.38	60.5	150	1.03	0.71	1.06
20016676	2½	63.5	2.87	72.9	150	1.03	0.87	1.29
20016678	3	76.2	3.47	88.1	150	1.03	1.37	2.04
20016683	4	101.6	4.50	114.3	150	1.03	1.80	2.68
20016689	6	152.4	6.49	164.9	150	1.03	2.53	3.76

**Air & Multipurpose**  
General Purpose  
Heavy Duty  
Push-on

Chemical Transfer

Cleaning Equipment

**Food**  
Transfer  
Washdown

Marine

**Material Handling**  
Abrasives  
Bulk Transfer  
Cement & Concrete

Mining

**Petroleum**  
Aircraft Fueling  
Dispensing  
Dock  
Transfer

Spray

Steam

Vacuum

LPG Delivery

**Water**  
Discharge  
Suction & Discharge  
Washdown

Welding

Coupling Systems

Equipment

Appendix

# Water Suction & Discharge



**Air & Multipurpose**  
 General Purpose  
 Heavy Duty  
 Push-on

Chemical Transfer

Cleaning Equipment

**Food**  
 Transfer  
 Washdown

Marine

**Material Handling**  
 Abrasives  
 Bulk Transfer  
 Cement & Concrete

Mining

**Petroleum**  
 Aircraft Fueling  
 Dispensing  
 Dock  
 Transfer

Spray

Steam

Vacuum

LPG Delivery

**Water**  
 Discharge  
 Suction & Discharge  
 Washdown

Welding

Coupling Systems

Equipment

Appendix

	Page	Rubber	Thermoplastic	Clear	Temp. Range	Tube Compound
Cold Blue	242		Yes	Yes	-40°F to 150°F (-40°C to 66°C)	PVC
Green Hornet XF	243		Yes		-40°F to 180°F (-40°C to 82°C)	TPR/PVC
Flexwing Water S&D	246	Yes			-25°F to 180°F (-23°C to 82°C)	SBR
Prospector S&D	248	Yes			-25°F to 200°F (-32°C to 93°C)	SBR
Spiraflex 1600	244		Yes		0°F to 158°F (-18°C to 70°C)	PVC
Spiraflex Aggie PVC	245		Yes	Yes	0°F to 158°F (-18°C to 70°C)	PVC
Velocity WT	241		Yes	Yes	-13°F to 140°F (-25°C to 60°C)	
Versiflo 150 Water S&D	247	Yes			-25°F to 200°F (-23°C to 93°C)	EPDM



# Velocity™ WT



## Product Specifications

The Velocity Water Transfer Hose gets water where you need it, efficiently and fast. This tough clear PVC hose lets you see water in motion, even in the most demanding applications. Whether you need full suction or transfer, the Velocity WT is the hose for your jobsite.

### Application

For water transfer. PVC Premium Heavy-Duty Clear Water Suction Hose. Premium heavy-duty construction for great durability. Clear PVC allows for visual confirmation of product flow.

### Construction Tube

Flexible PVC, rigid PVC helix, synthetic braiding, smooth bore, corrugate OD.

### Temperature Range

-13°F to 140°F (-25°C to 60°C)

### Couplings

Contact fitting manufacturer for proper fitting recommendation and coupling procedure.

### Order Codes

591-101

## Velocity™ WT

Part #	ID		Nom. OD		Max. WP @ 72°F (22°C)		Bend Radius	Vacuum HG @ 72°F (22°C)		Length
	in.	mm	in.	mm	psi	MPa	in.	in.	mm	ft
20762594	1½	38.1	2.03	51.7	110	0.76	2½	29	737	100
20762595	2	50.8	2.46	62.5	100	0.69	4	29	737	100
20635650	3	76.2	3.71	94.5	100	0.69	6	29	737	100
20635651	4	101.6	4.75	120.6	75	0.52	7	29	737	100
20761726	4	101.6	4.75	120.6	75	0.52	7	29	737	60
20630166	6	152.4	7.15	181.6	70	0.48	10	29	737	100
20762596	6	152.4	7.15	181.6	70	0.48	10	29	737	60
20761732	8	203.2	9.2	233.8	60	0.41	15	29	737	20

**Air & Multipurpose**  
General Purpose  
Heavy Duty  
Push-on

Chemical Transfer

Cleaning Equipment

**Food**  
Transfer  
Washdown

Marine

**Material Handling**  
Abrasives  
Bulk Transfer  
Cement & Concrete

Mining

**Petroleum**  
Aircraft Fueling  
Dispensing  
Dock  
Transfer

Spray

Steam

Vacuum

LPG Delivery

**Water**  
Discharge  
Suction & Discharge  
Washdown

Welding

Coupling Systems

Equipment

Appendix

# Cold Blue™



## Product Specifications

### Application

A lightweight, medium-duty water suction and discharge hose for industrial, construction, agricultural, mining and other applications where low temperature flexibility is required.

### Construction Tube

Clear flexible PVC

### Reinforcement

Blue rigid PVC helix

### Temperature Range

-40°F to 150°F (-40°C to 65°C)

### Branding

Not branded

### Packaging

100' coils, covered with corrugated cardboard and wrapped with clear stretch film.

### Order Codes

586-518

## Cold Blue™

SAP #	ID		Nom. OD		Max. WP		Bend Radius		Vacuum HG		Weight	
	Clear	in.	mm	in.	mm	psi	MPa	in.	mm	in.	mm	lb./ft.
20446623	3/4	19.1	.99	25.1	120	.83	.163	.242	29	737	3	76
20442995	1	25.4	1.25	31.8	106	.73	.229	.341	29	737	5	127
20439810	1¼	31.8	1.54	39.2	99	.68	.305	.454	29	737	5	127
20439811	1½	38.1	1.77	44.9	89	.61	.372	.559	29	737	6	152
20187679	2	50.8	2.33	59.2	80	.55	.583	.869	29	737	8	203
20439812	2½	63.5	2.87	72.9	65	.45	.840	1.25	29	737	10	254
20187760	3	76.2	3.40	86.5	65	.45	1.01	1.50	29	737	12	305
20187761	4	101.6	4.50	114.0	55	.38	1.65	2.46	29	737	16	406
20444339	6	152.4	6.62	168.2	47	.32	3.27	4.87	29	737	36	914

Testing performed at 70°F.

Air & Multipurpose

General Purpose

Heavy Duty

Push-on

Chemical Transfer

Cleaning Equipment

Food

Transfer

Washdown

Marine

Material Handling

Abrasives

Bulk Transfer

Cement & Concrete

Mining

Petroleum

Aircraft Fueling

Dispensing

Dock

Transfer

Spray

Steam

Vacuum

LPG Delivery

Water

Discharge

Suction & Discharge

Washdown

Welding

Coupling Systems

Equipment

Appendix

# Green Hornet® XF



## Product Specifications

### Application

Medium-duty, light-weight construction; retains flexibility in cold weather. Smooth-bore tube minimizes material buildup and resists a variety of chemicals found in agricultural and sanitary industries. Slightly corrugated outer helix promotes abrasion resistance, low coefficient of friction and ease of coupling. Common uses can be found in waste management, construction, agricultural, marine and manufacturing industries.

### Construction Tube

Black thermoplastic rubber, RMA Class B (medium oil resistance)

### Reinforcement

Rigid, lime-green polyethylene helix; available in a variety of custom colors

### Temperature Range

-40°F to 180°F (-40°C to 82°C)

### Packaging

100' lengths, coiled and polywrapped

### Branding (Spiral)

Not branded

### Couplings

Contact fitting manufacturer for proper fitting recommendation and coupling procedure

### Order Codes

586-551

## Green Hornet® XF

SAP #	ID		Nom. OD		Max. WP		Bend Radius		Weight	
	in.	mm	in.	mm	psi	MPa	in.	mm	lb./ft.	kg/m
20450178	1¼	31.8	1.53	39.0	50	0.35	2.5	63.5	0.27	0.40
20450177	1½	38.1	1.78	45.3	50	0.35	3	76.2	0.32	0.48
20450179	2	50.8	2.40	61.0	50	0.35	4	101.6	0.56	0.83
20450350	2½	63.5	2.99	74.9	50	0.35	5	127.0	0.75	1.12
20450351	3	76.2	3.47	88.1	45	0.31	5	127.0	0.92	1.37
20450352	4	101.6	4.67	118.4	40	0.28	9	228.6	1.60	2.39
20450353	6	152.4	6.75	171.4	25	0.17	20	508.0	2.88	4.30

**Air & Multipurpose**  
General Purpose  
Heavy Duty  
Push-on

Chemical Transfer

Cleaning Equipment

**Food**  
Transfer  
Washdown

Marine

**Material Handling**  
Abrasives  
Bulk Transfer  
Cement & Concrete

Mining

**Petroleum**  
Aircraft Fueling  
Dispensing  
Dock  
Transfer

Spray

Steam

Vacuum

LPG Delivery

**Water**  
Discharge  
Suction & Discharge  
Washdown

Welding

Coupling Systems

Equipment

Appendix

# SpiraFlex® 1600



## Product Specifications

### Application

For water suction and discharge service in construction and septic tank cleaning operations, and for general industrial and agricultural applications where mild chemical resistance is required.

### Branding

Not branded

### Couplings

Contact fitting manufacturer for proper fitting recommendation and coupling procedure.

### Construction Tube

Olive green Pliovic® with high-density rigid helix

### Order Codes

586-411

### Reinforcement

Olive green Pliovic® with high-density rigid helix

### Temperature Range

0°F to 158°F (-9°C to 70°C)

### Packaging

3/4"-6" - 100' lengths, coiled and polywrapped

8"-10" - 20' lengths, coiled and polywrapped

## SpiraFlex® 1600

SAP #	ID	Nom. OD		Max. WP		Bend Radius		Vacuum HG		Weight		
		in.	mm	in.	mm	psi	MPa	in.	mm	in.	mm	lb./ft.
20013191	3/4	19.1	0.98	24.9	130	0.90	3	83	29	737	0.18	0.27
20013194	1	25.4	1.24	31.5	106	0.73	5	114	29	737	0.25	0.37
20013197	1¼	31.8	1.53	38.9	99	0.68	5	127	29	737	0.32	0.48
20013203	1½	38.1	1.78	45.2	89	0.61	6	152	29	737	0.37	0.55
20013209	2	50.8	2.32	58.9	79	0.54	8	203	29	737	0.61	0.91
20013213	2½	63.5	2.85	72.4	65	0.45	10	254	29	737	0.87	1.29
20013219	3	76.2	3.41	86.6	65	0.45	12	305	29	737	1.08	1.61
20013223	4	101.6	4.46	113.3	55	0.38	16	406	29	737	1.69	2.51
20013231	6	152.4	6.57	166.9	47	0.32	36	914	29	737	3.05	4.54
20013236	8	203.2	8.92	226.6	40	0.28	60	1524	20	508	6.35	9.45
20013239	10	254.0	10.93	277.6	35	0.24	100	2540	20	508	8.75	13.04

Air & Multipurpose  
General Purpose  
Heavy Duty  
Push-on

Chemical Transfer

Cleaning Equipment

Food  
Transfer  
Washdown

Marine

Material Handling  
Abrasives  
Bulk Transfer  
Cement & Concrete

Mining

Petroleum  
Aircraft Fueling  
Dispensing  
Dock  
Transfer

Spray

Steam

Vacuum

LPG Delivery

Water  
Discharge  
Suction & Discharge  
Washdown

Welding

Coupling Systems

Equipment

Appendix

# SpiraFlex® Aggie PVC



## Product Specifications

### Application

A general-purpose water suction hose for use in industrial, agriculture and construction applications.

### Construction Tube

Clear Pliovic®

### Reinforcement

High-density white rigid Pliovic helix

### Temperature Range

0°F to 158°F (-9°C to 70°C)

### Packaging

100' lengths coiled and polywrapped

### Branding (Spiral)

Not branded

### Couplings

Contact fitting manufacturer for proper fitting recommendation and coupling procedure.

### Order Codes

586-453

### SpiraFlex®

SAP #	ID		Nom. OD		Max. WP		Bend Radius		Vacuum HG		Weight	
	Clear	in.	mm	in.	mm	psi	MPa	in.	mm	in.	mm	lb./ft.
20013491	3/4	19.1	1.00	25.4	120	0.83	3.0	76	29	737	0.18	0.27
20013493	1	25.4	1.24	31.5	106	0.73	4.5	114	29	737	0.23	0.34
20013495	1¼	31.8	1.53	38.9	99	0.68	5.0	127	29	737	0.34	0.51
20013497	1½	38.1	1.78	45.2	89	0.61	6.0	152	29	737	0.38	0.57
20013500	2	50.8	2.31	58.7	79	0.54	8.0	203	29	737	0.58	0.86
20013504	2½	63.5	2.85	72.4	65	0.45	10.0	254	29	737	0.90	1.34
20013507	3	76.2	3.41	86.6	65	0.45	12.0	305	29	737	1.07	1.59
20013510	4	101.6	4.47	113.5	55	0.38	16.0	406	29	737	1.69	2.51
20013516	6	152.4	6.60	167.6	47	0.32	36.0	914	29	737	3.29	4.90

**Air & Multipurpose**  
General Purpose  
Heavy Duty  
Push-on

Chemical Transfer

Cleaning Equipment

**Food**  
Transfer  
Washdown

Marine

**Material Handling**  
Abrasives  
Bulk Transfer  
Cement & Concrete

Mining

**Petroleum**  
Aircraft Fueling  
Dispensing  
Dock  
Transfer

Spray

Steam

Vacuum

LPG Delivery

**Water**  
Discharge  
Suction & Discharge  
Washdown

Welding

Coupling Systems

Equipment

Appendix

# Flexwing® Water S&D



## Product Specifications

### Application

A general-purpose, economical hose for applications in light or medium water suction and discharge operations. Rated for full vacuum. Used in various industrial, agricultural and construction areas.

### Construction Tube

Black SBR Synthetic Rubber

### Cover

Black SBR Synthetic Rubber

### Reinforcement

Synthetic fabric plies with internal wire helix

### Temperature Range

-25°F to 180°F (-32°C to 82°C)

### Packaging

3/4"-6" - 100' lengths, coiled and polywrapped  
8"-12" - Custom length

### Branding

Example: Flexwing® Water S&D

### Couplings

Contact fitting manufacturer for proper fitting recommendation and coupling procedure.

### Order Codes

542-249 (3/4"-6")

541-249 (8"-12")

## Flexwing® Water S&D

SAP #	ID	Nom. OD		Max. WP		Bend Radius		Vacuum HG		Weight		
		in.	mm	in.	mm	psi	MPa	in.	mm	in.	mm	lb./ft.
20026570	3/4	19.0	1.09	27.9	150	0.86	2	50	29	737	0.33	0.49
20026608	1	25.3	1.34	34.1	150	0.86	2	50	29	737	0.41	0.61
20026605	1¼	32.0	1.61	40.8	150	0.86	4	100	29	737	0.50	0.75
20026606	1½	38.0	1.84	46.9	150	0.86	4	100	29	737	0.63	0.94
20462936	2	51.1	2.38	60.4	150	0.86	7	180	29	737	0.84	1.25
20462937	2½	63.6	2.89	73.3	150	0.86	10	250	29	737	1.08	1.61
20462938	3	76.1	3.42	86.8	150	0.86	14	360	29	737	1.46	2.18
20462939	3½	90.0	3.97	100.9	150	0.86	14	360	29	737	1.80	2.68
20462940	4	102.1	4.45	113.1	150	0.86	18	460	29	737	2.03	3.02
20462941	5	127.3	5.53	140.5	150	0.86	20	510	29	737	3.34	4.98
20462942	6	152.6	6.63	168.0	150	0.86	24	610	29	737	4.67	6.96
20026598	8	203.5	8.75	222.3	125	0.86	48	1200	29	737	7.56	11.26
20129508	10	253.9	10.97	278.3	125	0.86	60	1500	29	737	12.34	18.39
20129505	12	305.5	12.19	335.4	125	0.86	72	1800	29	737	19.07	28.41

Air & Multipurpose

General Purpose

Heavy Duty

Push-on

Chemical Transfer

Cleaning Equipment

Food

Transfer

Washdown

Marine

Material Handling

Abrasives

Bulk Transfer

Cement & Concrete

Mining

Petroleum

Aircraft Fueling

Dispensing

Dock

Transfer

Spray

Steam

Vacuum

LPG Delivery

Water

Discharge

Suction & Discharge

Washdown

Welding

Coupling Systems

Equipment

Appendix

# Verisflo® 150 Water S&D



## Product Specifications

### Application

General-purpose water suction and discharge for medium- to heavy-duty applications. Can be used in Lasso® applications.

### Construction Tube

Black EPDM synthetic rubber

### Reinforcement

Black EPDM synthetic rubber (wrapped finish)

### Temperature Range

-25°F to 200°F (-32°C to 93°C)

### Packaging

542-528 - 100' lengths, coiled and polywrapped  
541-528 - custom lengths

### Branding (Spiral)

Example: Continental ContiTech Versiflo® 150 Water Suction & Discharge

### Couplings

Contact fitting manufacturer for proper fitting recommendation and coupling procedure.

### Order Codes

542-528 (1 1/4"-6")  
541-528 (8"-14")

## Verisflo® 150 Water S&D

SAP #	ID		Nom. OD		Max. WP		Bend Radius		Vacuum HG		Weight	
	in.	mm	in.	mm	psi	MPa	in.	mm	in.	mm	lb./ft.	kg/m
20016820	1¼	31.8	1.63	41.4	150	1.03	4	102	29	737	0.53	0.79
20016822	1½	38.1	1.87	47.5	150	1.03	4	102	29	737	0.65	0.97
20016828	2	50.8	2.39	60.7	150	1.03	7	178	29	737	0.87	1.29
20016831	2½	63.5	2.89	73.4	150	1.03	10	254	29	737	1.08	1.61
20016834	3	76.2	3.42	86.9	150	1.03	14	356	29	737	1.44	2.14
20016838	4	101.6	4.45	113.0	150	1.03	18	457	29	737	2.00	2.98
20016841	6	152.4	6.60	167.6	150	1.03	24	610	29	737	4.56	6.79
20115258	8	203.0	8.75	238.0	150	1.03	48	1200	29	737	7.40	11.00
20669573	10	254.0	10.96	278.0	150	1.03	60	1500	29	737	12.20	18.20
20669574	12	305.0	13.23	336.0	150	1.03	72	1800	29	737	18.70	27.90

Air & Multipurpose  
General Purpose  
Heavy Duty  
Push-on

Chemical Transfer

Cleaning Equipment

Food  
Transfer  
Washdown

Marine

Material Handling  
Abrasives  
Bulk Transfer  
Cement & Concrete

Mining

Petroleum  
Aircraft Fueling  
Dispensing  
Dock  
Transfer

Spray

Steam

Vacuum

LPG Delivery

Water  
Discharge  
Suction & Discharge  
Washdown

Welding

Coupling Systems

Equipment

Appendix

# Prospector™ Water S&D



## Product Specifications

### Application

Available 1" to 6" ID  
 Water suction and discharge hose for medium- to heavy-duty applications, used in the discharge of fluids from frac tanks

### Couplings

Using ContiTech brand of Insta-Lock™ cam & groove fittings

### Order Codes

542-032

### Construction Tube

Synthetic rubber tuber with black synthetic rubber wrapped cover with embossed layline

### Temperature Range

-25°F to 200°F (-32°C to 93°C)

## Prospector™ Water S&D

Part #	ID		Nom. OD		Max. WP		Bend Radius		Vacuum HG		Weight	
	in.	mm	in.	mm	psi	MPa	in.	mm	in.	mm	lb./ft.	kg/m
20704261	1	25.4	1.348	34.2	150	1.03	2	51	29	737	0.42	0.625
20704263	1½	38.1	1.852	47.0	150	1.03	4	102	29	737	0.64	0.948
20704264	2	50.8	2.352	59.7	150	1.03	7	178	29	737	0.83	1.232
20704265	2½	63.5	2.893	73.5	150	1.03	10	255	29	737	1.09	1.624
20704266	3	76.2	3.436	87.3	150	1.03	14	356	29	737	1.19	1.771
20704267	4	101.6	4.447	112.9	150	1.03	18	457	29	737	2.05	3.052
20704268	5	152.4	6.613	168.0	150	1.03	24	612	29	737	4.91	7.307

Air & Multipurpose

General Purpose

Heavy Duty

Push-on

Chemical Transfer

Cleaning Equipment

Food

Transfer

Washdown

Marine

Material Handling

Abrasives

Bulk Transfer

Cement & Concrete

Mining

Petroleum

Aircraft Fueling

Dispensing

Dock

Transfer

Spray

Steam

Vacuum

LPG Delivery

Water

Discharge

Suction & Discharge

Washdown

Welding

Coupling Systems

Equipment

Appendix



# Water Washdown



	Page	Temp. Range	Non-Marking Cover	Superior Oil Resistance Cover	Superior Abrasion Cover	Microban Cover	Tapered Nozzle	Textile	Wire
Fortress 300	87	-20°F to 200°F (-29°C to 93°C)	Yes	Yes	Yes	Yes		Yes	
Fortress 1000	88	-20°F to 200°F (-29°C to 93°C)	Yes	Yes	Yes	Yes		Yes	
Fortress 3000	89	-20°F to 250°F (-29°C to 121°C)	Yes	Yes	Yes	Yes			Yes
Gauntlet 1500	60	-20°F to 200°F (-29°C to 93°C)	Yes*	Yes	Yes			Yes	
Plicord Washdown	251	-25°F to 200°F (-29°C to 93°C)					Yes	Yes	
Pulp & Paper Washdown	252	-25°F to 200°F (-29°C to 93°C)					Yes	Yes	
Sani-Wash 300	92	-40°F to 205°F (-40°C to 96°C)	Yes					Yes	
Super Sani-Wash 300	91	-40°F to 200°F (-40°C to 93°C)	Yes			Yes		Yes	
Sani-Wash Plus 300	93	-20°F to 200°F (-29°C to 93°C)	Yes	Yes				Yes	
Sureline	250	-40°F to 190°F (-40°C to 88°C)	Yes*					Yes	

\*Nonblack Colors

**Air & Multipurpose**  
General Purpose  
Heavy Duty  
Push-on

Chemical Transfer

Cleaning Equipment

**Food**  
Transfer  
Washdown

Marine

**Material Handling**  
Abrasives  
Bulk Transfer  
Cement & Concrete

Mining

**Petroleum**  
Aircraft Fueling  
Dispensing  
Dock  
Transfer

Spray

Steam

Vacuum

LPG Delivery

**Water**  
Discharge  
Suction & Discharge  
Washdown

Welding

Coupling Systems

Equipment

Appendix

# Sureline®



## Product Specifications

### Application

For a wide range of industrial, construction, and agricultural water discharge applications in which a general-service water hose is needed.

### Construction Tube

EPDM synthetic rubber, RMA Class C (limited oil resistance)

### Cover

Red or black EPDM synthetic rubber

### Reinforcement

Spiral synthetic yarn

### Temperature Range

-40°F to 190°F (-40°C to 88°C)

### Packaging

3/16"-3/4" - 500' reels, maximum 3 pieces, 50' increments  
 1" - 450' reels, maximum 3 pieces, 50' increments  
 1¼" - 400' reels, maximum 3 pieces, 50' increments  
 1½" - 300' reels, maximum 3 pieces, 50' increments

### Branding (Spiral)

Example: 1/2" Sureline® Continental ContiTech 150 psi WP

### Couplings

Contact fitting manufacturer for proper fitting recommendation and coupling procedure.

### Order Codes

569-048 (red)  
 569-049 (black)

## Sureline®

SAP #		ID		Nom. OD		Max. WP		Weight	
Red	Black	in.	mm	in.	mm	psi	MPa	lb./ft.	kg/m
20026443	20026458	1/4	6.4	0.48	12.2	150	1.03	0.08	0.12
20026444	20026459	3/8	9.5	0.66	16.8	150	1.03	0.13	0.19
20026447	20026465	1/2	12.7	0.78	19.8	150	1.03	0.17	0.25
20026448	20026474	5/8	15.9	0.93	23.6	150	1.03	0.26	0.39
20026451	20026485	3/4	19.1	1.08	27.4	150	1.03	0.33	0.49
20026454	20026501	1	25.4	1.39	35.3	150	1.03	0.52	0.77
20026455	20026508	1¼	31.8	1.63	41.4	150	1.03	0.57	0.85
20026456	20026512	1½	38.1	1.88	47.8	150	1.03	0.68	1.01

Air & Multipurpose

General Purpose

Heavy Duty

Push-on

Chemical Transfer

Cleaning Equipment

Food

Transfer

Washdown

Marine

Material Handling

Abrasives

Bulk Transfer

Cement & Concrete

Mining

Petroleum

Aircraft Fueling

Dispensing

Dock

Transfer

Spray

Steam

Vacuum

LPG Delivery

Water

Discharge

Suction & Discharge

Washdown

Welding

Coupling Systems

Equipment

Appendix

# Plicord® Washdown with Optional Integral Tapered Nozzle



## Product Specifications

### Application

Plicord® Washdown hose is a quality water discharge hose for the environments typically found in paper mills and other industrial operations. Can be supplied with an integral rubber nozzle.

### Construction Tube

Black SBR synthetic rubber

### Cover

Black SBR synthetic rubber (wrapped impression). Also available in green or white cover (non-FDA).

### Reinforcement

Spiral-plied synthetic fabric

### Temperature Range

-25°F to 200°F (-32°C to 93°C)

### Packaging

50' lengths, coiled and polywrapped

### Branding (Spiral)

Example: Continental ContiTech Plicord® Washdown, 150 Max WP

### Couplings

Contact fitting manufacturer for proper fitting recommendation and coupling procedure. Also available with integral tapered nozzle.

### Non-Stock/Sizes

Hose: 400' minimum order/400' increments  
Hose with tapered nozzle: Two 50' lengths, two length increments

### Order Codes

542-454 (black)

542-455 (green)

542-507 (white)

## Plicord® Washdown

SAP #			ID	Nom. OD		Max. WP		Weight		
Black	Green	White	in.	mm	in.	mm	psi	MPa	lb./ft.	kg/m
20016718	20016737	20016775	3/4	19.1	1.17	29.7	150	1.03	0.36	0.54
20016722	20016742	20016781	1	25.4	1.42	36.1	150	1.03	0.45	0.67
20016727	20016745	20016784	1¼	31.8	1.69	42.9	150	1.03	0.55	0.82
20016729	20139579	20649827	1½	38.1	1.97	50.0	150	1.03	0.71	1.06

Orifice sizes: 3/4" ID-1/2" Orifice  
1" ID-1/2" Orifice  
1¼" ID-5/8" Orifice  
1½" ID-3/4" Orifice

Air & Multipurpose  
General Purpose  
Heavy Duty  
Push-on

Chemical Transfer

Cleaning Equipment

Food  
Transfer  
Washdown

Marine

Material Handling  
Abrasives  
Bulk Transfer  
Cement & Concrete

Mining

Petroleum  
Aircraft Fueling  
Dispensing  
Dock  
Transfer

Spray

Steam

Vacuum

LPG Delivery

Water  
Discharge  
Suction & Discharge  
Washdown

Welding

Coupling Systems

Equipment

Appendix

# Pulp & Paper Washdown with Optional Integral Tapered Nozzle



## Product Specifications

### Application

Heavy-duty water discharge hose for washdown service in pulp and paper mills where kink resistance is of major importance.

### Construction Tube

Black EPDM synthetic rubber (also available in white, non-FDA)

### Cover

Black EPDM synthetic rubber

### Reinforcement

Spiral-plied synthetic fabric

### Temperature Range

-25°F to 200°F (-32°C to 93°C)

### Packaging

50' lengths, coiled and polywrapped

### Branding (Spiral)

Example: Continental ContiTecg HD Washdown, 300 psi Max WP

### Couplings

Contact fitting manufacturer for proper fitting recommendation and coupling procedure. Also available with integral tapered nozzle.

### Non-Stock/Sizes

Hose: 400' minimum order/400' increments  
Hose with tapered nozzle: Two 50' lengths, two 50' length increments

### Order Codes

542-452

## Plicord® Versiflo® 125

SAP #	ID		Nom. OD		Max. WP		Weight	
	in.	mm	in.	mm	psi	MPa	lb./ft.	kg/m
20024998	3/4	19.1	1.30	33.0	300	2.07	0.47	0.70
20029385	1	25.4	1.62	41.2	300	2.07	0.67	1.00
20016713	1¼	31.8	1.88	47.8	300	2.07	0.81	1.21
20100952	1½	38.1	2.11	53.7	300	2.07	0.91	1.36

Orifice sizes: 3/4" ID-1/2" Orifice  
1" ID-1/2" Orifice  
1¼" ID-5/8" Orifice  
1½" ID-3/4" Orifice

Air & Multipurpose  
General Purpose  
Heavy Duty  
Push-on

Chemical Transfer

Cleaning Equipment

Food  
Transfer  
Washdown

Marine

Material Handling  
Abrasives  
Bulk Transfer  
Cement & Concrete

Mining

Petroleum  
Aircraft Fueling  
Dispensing  
Dock  
Transfer

Spray

Steam

Vacuum

LPG Delivery

Water  
Discharge  
Suction & Discharge  
Washdown

Welding

Coupling Systems

Equipment

Appendix



# Welding



	Page	Oxygen (Green)	Acetylene (Red)	Fuel Gases* (Red)	Flame and Oil Resistant Tube	Flame and Oil Resistant Cover
Twin-Line Welding (Grade R)	255	Yes	Yes	No	No	No
Twin-Line Welding (Grade RM)	256	Yes	Yes	No	No	Yes
Twin-Line Welding (Grade T)	257	Yes	Yes	Yes	Yes	Yes
Single Line Welding (Grade R)	259	Yes	Yes	No	No	No
Single Line Welding (Grade RM)	260	Yes	Yes	No	No	Yes
Single Line Welding (Grade T)	258	Yes	Yes	Yes	Yes	Yes

\*Fuel Gases are defined in RMA IP-7 welding hose standard. Flammable compressed gases commonly used in the welding and cutting industry including, but not limited to, acetylene, hydrogen, methane/natural gas, LP gas, propylene and methylacetylene propadiene stabilized.

RMA IP-7 and CGA E-1

## Air & Multipurpose

General Purpose  
Heavy Duty  
Push-on

## Chemical Transfer

## Cleaning Equipment

## Food

Transfer  
Washdown

## Marine

## Material Handling

Abrasives  
Bulk Transfer  
Cement & Concrete

## Mining

## Petroleum

Aircraft Fueling  
Dispensing  
Dock  
Transfer

## Spray

## Steam

## Vacuum

## LPG Delivery

## Water

Discharge  
Suction & Discharge  
Washdown

## Welding

## Coupling Systems

## Equipment

## Appendix

# Twin-Line Welding Grade R - Type VD



## Product Specifications

### Application

For welding service. Meets RMA IP-7 standard for Grade R welding hose.

### Construction Tube

EPDM synthetic rubber compatible with oxygen and acetylene gases

### Cover

EPDM synthetic rubber smooth surface

### Reinforcement

Spiral synthetic yarn

### Temperature Range

-40°F to 120°F (-40°C to 49°C)

### Packaging

500' reels

### Branding

Example: Twin-Line 1/4" Grade R Acetylene Only Std Duty Max. WP 200 psi Meets RMA IP-7-2008. Made In U.S.A. Continental ContiTech

### Couplings

Contact fitting manufacturer for proper fitting recommendation and coupling procedure..

### Order Codes

569-588

## Twin-Line Welding Grade R

SAP #	ID		Nom. OD		Max. WP		Weight	
	in.	mm	in.	mm	psi	MPa	lb./ft.	kg/m
20027120	3/16	4.8	0.44	11.2	200	1.38	0.13	0.19
20027170	1/4	6.4	0.53	13.5	200	1.38	0.18	0.27
20027203	5/16	7.9	0.59	15.0	200	1.38	0.22	0.33
20027224	3/8	9.5	0.66	16.8	200	1.38	0.26	0.39

Note: For Welding Hose Precautions, see Appendix C.

**Air & Multipurpose**  
General Purpose  
Heavy Duty  
Push-on

Chemical Transfer

Cleaning Equipment

**Food**  
Transfer  
Washdown

Marine

**Material Handling**  
Abrasives  
Bulk Transfer  
Cement & Concrete

Mining

**Petroleum**  
Aircraft Fueling  
Dispensing  
Dock  
Transfer

Spray

Steam

Vacuum

LPG Delivery

**Water**  
Discharge  
Suction & Discharge  
Washdown

**Welding**

Coupling Systems

Equipment

Appendix

# Twin-Line Welding Grade RM - Type VD



## Product Specifications

### Application

For welding service. Meets RMA IP-7 standard for Grade RM welding hose. Non-conductive.

### Construction Tube

SBR synthetic rubber compatible with oxygen and acetylene gases

### Cover

Chemivic™ synthetic rubber smooth cover

### Reinforcement

Spiral synthetic yarn

### Temperature Range

-40°F to 120°F (-40°C to 49°C)

### Packaging

500' reels

### Branding

Example: Twin-Line 1/4" Grade RM Acetylene Only Std Duty Max. WP 200 psi Meets RMA IP-7-2008. Made In U.S.A. Continental ContiTech

### Couplings

Contact fitting manufacturer for proper fitting recommendation and coupling procedure.

### Order Codes

569-598

## Twin-Line Welding Grade RM

SAP #	ID		Nom. OD		Max. WP		Weight	
	in.	mm	in.	mm	psi	MPa	lb./ft.	kg/m
20027317	3/16	4.8	0.44	11.2	200	1.38	0.15	0.22
20027342	1/4	6.4	0.53	13.5	200	1.38	0.21	0.31
20027356	5/16	7.9	0.59	15.0	200	1.38	0.25	0.37
20182609	3/8	9.5	0.66	16.8	200	1.38	0.29	0.43

Note: For Welding Hose Precautions, see Appendix C.

### Air & Multipurpose

General Purpose

Heavy Duty

Push-on

Chemical Transfer

Cleaning Equipment

Food

Transfer

Washdown

Marine

### Material Handling

Abrasives

Bulk Transfer

Cement & Concrete

Mining

Petroleum

Aircraft Fueling

Dispensing

Dock

Transfer

Spray

Steam

Vacuum

LPG Delivery

Water

Discharge

Suction & Discharge

Washdown

Welding

Coupling Systems

Equipment

Appendix



# Twin-Line Welding Grade T - Type VD



## Product Specifications

### Application

For welding service. Meets RMA IP-7 and CGA E-1 standards for Grade T welding hose. Non-conductive.

### Construction Tube

Wingprene® synthetic rubber compatible with all common welding fuel gases

### Cover

Chemivic™ synthetic rubber smooth cover

### Reinforcement

Spiral synthetic yarn

### Temperature Range

-40°F to 120°F (-40°C to 49°C)

### Packaging

500' reels

### Branding

Example: Twin-Line 1/4" Grade T Fuel Gas Std Duty Max. WP 200 psi Meets RMA IP-7-2008/Cga E-1. Made In U.S.A. Continental ContiTech

### Couplings

Contact fitting manufacturer for proper fitting recommendation and coupling procedure..

### Order Codes

569-618

## Twin-Line Welding Grade T

SAP #	ID		Nom. OD		Max. WP		Weight	
	in.	mm	in.	mm	psi	MPa	lb./ft.	kg/m
20027443	3/16	4.8	0.44	11.2	200	1.38	0.13	0.19
20027465	1/4	6.4	0.53	13.5	200	1.38	0.18	0.27
20027480	5/16	7.9	0.59	15.0	200	1.38	0.22	0.33
20027498	3/8	9.5	0.66	16.8	200	1.38	0.26	0.39

Note: For Welding Hose Precautions, see Appendix C.

**Air & Multipurpose**  
General Purpose  
Heavy Duty  
Push-on

Chemical Transfer

Cleaning Equipment

**Food**  
Transfer  
Washdown

Marine

**Material Handling**  
Abrasives  
Bulk Transfer  
Cement & Concrete

Mining

**Petroleum**  
Aircraft Fueling  
Dispensing  
Dock  
Transfer

Spray

Steam

Vacuum

LPG Delivery

**Water**  
Discharge  
Suction & Discharge  
Washdown

Welding

Coupling Systems

Equipment

Appendix

# Single Line Welding Grade T



## Product Specifications

### Application

For welding service. Meets RMA IP-7 and CGA E-1 standards for Grade T welding hose. Non-conductive.

### Construction Tube

Wingprene® synthetic rubber compound compatible with all common welding fuel gases

### Cover

Chemivic™ synthetic rubber ribbed surface

### Reinforcement

Spiral synthetic yarn

### Temperature Range

-40°F to 120°F (-40°C to 49°C)

### Packaging

500' reels

### Branding

Example: 1/4" Grade T Fuel Gas Std Duty Max. WP 200 psi  
Meets RMA IP-7-2008/Cga E-1. Made In U.S.A. Continental ContiTech

### Couplings

Contact fitting manufacturer for proper fitting recommendation and coupling procedure.

### Order Codes

569-619 (red cover) (acetylene or other common welding fuel gas)  
569-620 (green cover) (oxygen)

## Single Line Welding Grade T

		ID		Nom. OD		Max. WP		Weight	
		in.	mm	in.	mm	psi	MPa	lb./ft.	kg/m
Red (Acetylene)	20685102	3/16	4.8	0.44	11.1	200	1.38	0.08	0.12
	20027506	1/4	6.4	0.53	13.5	200	1.38	0.10	0.15
Green (Oxygen)	20309892	5/16	7.9	0.60	15.1	200	1.38	0.12	0.18
	20027510	3/8	9.5	0.66	16.7	200	1.38	0.14	0.21

Note: For Welding Hose Precautions, see Appendix C.

### Air & Multipurpose

General Purpose

Heavy Duty

Push-on

Chemical Transfer

Cleaning Equipment

Food

Transfer

Washdown

Marine

### Material Handling

Abrasives

Bulk Transfer

Cement & Concrete

Mining

Petroleum

Aircraft Fueling

Dispensing

Dock

Transfer

Spray

Steam

Vacuum

LPG Delivery

Water

Discharge

Suction & Discharge

Washdown

Welding

Coupling Systems

Equipment

Appendix

# Single Line Welding Grade R



## Product Specifications

### Application

For welding service. Meets RMA IP-7 standard for Grade R welding hose.

### Construction Tube

EPDM synthetic rubber

### Cover

EPDM synthetic rubber ribbed surface

### Reinforcement

Spiral synthetic yarn

### Temperature Range

-40°F to 120°F (-40°C to 49°C)

### Packaging

500' reels

### Branding

Example: 1/4" Grade R Acetylene Only Std Duty Max. WP 200 psi Meets RMA IP-7-2008. Made In U.S.A. Continental ContiTech

### Couplings

Contact fitting manufacturer for proper fitting recommendation and coupling procedure.

### Order Codes

569-591 (red cover) (acetylene)  
569-592 (green cover) (oxygen)

## Single Line Welding Grade R

SAP #		ID		Nom. OD		Max. WP		Weight	
Red (Acetylene)	Green (Oxygen)	in.	mm	in.	mm	psi	MPa	lb./ft.	kg/m
20027257	20027276	3/16	4.8	0.44	11.1	200	1.38	0.08	0.12
20027261	20027280	1/4	6.4	0.53	13.5	200	1.38	0.10	0.15
20027267	20027292	5/16	7.9	0.60	15.1	200	1.38	0.11	0.16
20027271	20027295	3/8	9.5	0.66	16.7	200	1.38	0.13	0.19

Note: For Welding Hose Precautions, see Appendix C.

**Air & Multipurpose**  
General Purpose  
Heavy Duty  
Push-on

Chemical Transfer

Cleaning Equipment

**Food**  
Transfer  
Washdown

Marine

**Material Handling**  
Abrasives  
Bulk Transfer  
Cement & Concrete

Mining

**Petroleum**  
Aircraft Fueling  
Dispensing  
Dock  
Transfer

Spray

Steam

Vacuum

LPG Delivery

**Water**  
Discharge  
Suction & Discharge  
Washdown

**Welding**

Coupling Systems

Equipment

Appendix

# Single Line Welding Grade RM



## Product Specifications

### Application

For welding service. Meets RMA IP-7 standard for Grade RM welding hose.

### Construction Tube

SBR synthetic rubber (non-conductive)

### Cover

Chemivic™ synthetic rubber ribbed surface

### Reinforcement

Spiral synthetic yarn

### Temperature Range

-40°F to 120°F (-40°C to 49°C)

### Packaging

500' reels

### Branding

Example: 1/4" Grade RM Oxygen Std Duty Max. WP 200 psi Meets RMA IP-7-2008. Made In U.S.A. Continental ContiTech

### Couplings

Contact fitting manufacturer for proper fitting recommendation and coupling procedure.

### Order Codes

569-589 (red cover) (acetylene)

569-590 (green cover) (oxygen)

## Single Line Welding Grade RM

	ID		Nom. OD		Max. WP		Weight			
	Red (Acetylene)	Green (Oxygen)	in.	mm	in.	mm	psi	MPa	lb./ft.	kg/m
	20027237	20027249	1/4	6.4	0.53	13.5	200	1.38	0.10	0.15

Note: For Welding Hose Precautions, see Appendix C.

### Air & Multipurpose

General Purpose  
Heavy Duty  
Push-on

### Chemical Transfer

### Cleaning Equipment

Food  
Transfer  
Washdown

### Marine

### Material Handling

Abrasives  
Bulk Transfer  
Cement & Concrete

### Mining

### Petroleum

Aircraft Fueling  
Dispensing  
Dock  
Transfer

### Spray

### Steam

### Vacuum

### LPG Delivery

### Water

Discharge  
Suction & Discharge  
Washdown

### Welding

### Coupling Systems

### Equipment

### Appendix



# Coupling Systems



		Page	Aluminum	Stainless Steel	Brass	Carbon Steel	Steel
Marine	Insta-Lock Dust Cap	271	Yes	Yes	Yes	No	No
	Insta-Lock Dust Plug	272	Yes	Yes	Yes	No	Yes
Material Handling Abrasives Bulk Transfer Cement & Concrete	Insta-Lock Fittings Reducers & Jump Sizes	269	Yes	Yes		Yes	Yes
	Insta-Lock Gaskets	274				No	No
	Insta-Lock Interlocking Ferrules	275		Yes		Yes	
Mining	Insta-Lock Interlocking Stainless Steel Male NPT Hose Stem	270		Yes			
	Insta-Lock Repair Kits	273		Yes	Yes		
Petroleum Aircraft Fueling Dispensing Dock Transfer	Insta-Lock Type A	263	Yes	Yes	Yes		
	Insta-Lock Type B	264	Yes	Yes	Yes		
	Insta-Lock Type C	265	Yes	Yes	Yes		
Spray	Insta-Lock Type D	266	Yes	Yes	Yes		
	Insta-Lock Type E	267	Yes	Yes	Yes		
Steam	Insta-Lock Type F	268	Yes	Yes	Yes	No	Yes
	Pressure Washer Fittings	277					Yes
Vacuum	Stainless Steel & Aluminum Crimp Sleeves for Infinity™ and Paladin® Hose	276	Yes	Yes			

## Air & Multipurpose

General Purpose

Heavy Duty

Push-on

Chemical Transfer

Cleaning Equipment

## Food

Transfer

Washdown

Marine

## Material Handling

Abrasives

Bulk Transfer

Cement & Concrete

Mining

## Petroleum

Aircraft Fueling

Dispensing

Dock

Transfer

Spray

Steam

Vacuum

LPG Delivery

## Water

Discharge

Suction & Discharge

Washdown

Welding

Coupling Systems

Equipment

Appendix

# Insta-Lock™ Type A Male Adapter X Female NPT Thread

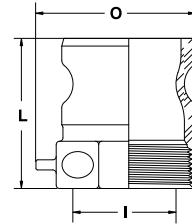

## Product Specifications

### Application

Type A fitting is commonly threaded onto a pipe, threaded hose end or manifold system, which is connected and disconnected on a regular basis. Insta-Lock™ fittings are designed for liquids and dry bulk. Consult the chemical resistance guide for specific chemical recommendations.

### Materials

Aluminum, 316# Stainless Steel and Brass

### Pressure Rating

Sizes 1/2"-2", 250 psi; sizes 2½"-4", 150 psi; sizes 5"-6", 75 psi. Recommended working pressure ratings based on ambient temperature 70°F (21°C).

### Branding

Example: Continental ContiTech A200SS

### Order Codes

650-825 (aluminum), 650-833 (brass),  
650-841 (stainless steel)

### Insta-Lock™ Type A Male Adapter X Female NPT Thread

Size	Aluminum	Stainless Steel	Brass
1/2	A050AL	A050SS	A050BR
3/4	A075AL	A075SS	A075BR
1	A100AL	A100SS	A100BR
1¼	A125AL	A125SS	A125BR
1½	A150AL	A150SS	A150BR
2	A200AL	A200SS	A200BR
2½	A250AL	A250SS	A250BR
3	A300AL	A300SS	A300BR
4	A400AL	A400SS	A400BR
5	A500AL	A500SS	A500BR
6	A600AL	A600SS	A600BR

Size	Distance Chain Lug Extends from Body	Overall Length (L)	Maximum Width Across Adapter (O)	Minimum ID (I)
in.	in.	in.	in.	in.
1/2	0.375	1.656	1.500	0.500
3/4	0.375	1.656	1.688	0.781
1	0.375	2.163	1.804	0.875
1¼	0.375	2.437	2.237	1.063
1½	0.375	2.531	2.368	1.375
2	0.375	2.781	2.909	1.750
2½	0.375	3.093	3.585	2.187
3	0.375	3.281	4.009	2.812
4	0.375	3.528	5.257	3.750
5	0.375	3.813	6.438	4.688
6	0.375	3.656	7.688	5.750

Note: Continental ContiTech Insta-Lock™ fittings are never to be used in steam or compressed air service.

Air & Multipurpose  
General Purpose  
Heavy Duty  
Push-on

Chemical Transfer

Cleaning Equipment

Food  
Transfer  
Washdown

Marine

Material Handling  
Abrasives  
Bulk Transfer  
Cement & Concrete

Mining

Petroleum  
Aircraft Fueling  
Dispensing  
Dock  
Transfer

Spray

Steam

Vacuum

LPG Delivery

Water  
Discharge  
Suction & Discharge  
Washdown

Welding

Coupling Systems

Equipment

Appendix

# Insta-Lock™ Type B Female Coupler X Male NPT Thread

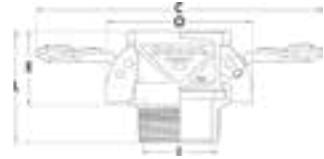

## Product Specifications

### Application

Type B fitting is normally threaded onto a pipe or manifold which joins to a rubber hose assembly that is connected and disconnected regularly. Insta-Lock™ fittings are designed for liquids and dry bulk. Consult the chemical resistance guide for specific chemical recommendations.

### Materials

Aluminum, 316# Stainless Steel and Brass

### Pressure Rating

Sizes 1/2"-2", 250 psi; sizes 2½"-4", 150 psi; sizes 5"-6", 75 psi. Recommended working pressure ratings based on ambient temperature 70°F (21°C) with Standard Nitrile gaskets.

### Branding

Example: Continental ContiTech B200SS

### Order Codes

650-826 (aluminum), 650-834 (brass),  
650-842 (stainless steel)

### Insta-Lock™ Type B Female Coupler X Male NPT Thread

Size	Aluminum	Stainless Steel	Brass
1/2	B050AL	B050SS	B050BR
3/4	B075AL	B075SS	B075BR
1	B100AL	B100SS	B100BR
1¼	B125AL	B125SS	B125BR
1½	B150AL	B150SS	B150BR
2	B200AL	B200SS	B200BR
2½	B250AL	B250SS	B250BR
3	B300AL	B300SS	B300BR
4	B400AL	B400SS	B400BR
5	B500AL	B500SS	B500BR
6	B600AL	B600SS	B600BR

Size	Max. Width with Cam Arms Closed (O)	Overall Length (L)	Exposed Length (E)	Minimum ID (I)	Max. Width with Cam Arms Extended (C)
in.	in.	in.	in.	in.	in.
1/2	2.469	1.906	1.188	0.469	4.969
3/4	2.781	2.031	1.313	0.688	5.261
1	2.920	2.500	1.625	0.875	5.367
1¼	3.510	2.937	2.000	1.063	7.669
1½	3.830	2.937	2.000	1.375	7.967
2	4.210	3.218	2.156	1.750	8.340
2½	4.720	3.718	2.250	2.187	8.837
3	5.680	4.000	2.468	2.812	10.435
4	6.780	4.218	2.593	3.750	11.538
5	7.813	4.406	2.625	4.688	12.571
6	9.344	4.750	2.844	5.750	16.096

Note: Continental ContiTech Insta-Lock™ fittings are never to be used in steam or compressed air service. Continental ContiTech Products Insta-Lock™ Cam Arms are designed exclusively for Insta-Lock™ fittings.



# Insta-Lock™ Type C Female Coupler X Hose Shank

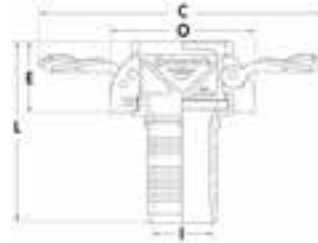

## Product Specifications

### Application

Type C fitting can be attached to a rubber hose with the use of interlocking ferrules, crimp sleeves, or bands. Insta-Lock™ fittings are designed for liquids and dry bulk. Consult the chemical resistance guide for specific chemical recommendations.

### Materials

Aluminum, 316# Stainless Steel and Brass

### Pressure Rating

Sizes 1/2"-2", 250 psi; sizes 2 1/2"-4", 150 psi; sizes 5"-6", 75 psi. Recommended working pressure ratings based on ambient temperature 70°F (21°C) with Standard Nitrile gaskets.

### Branding

Example: Continental ContiTech C200SS

### Order Codes

650-827 (aluminum), 650-835 (brass),  
650-843 (stainless steel)

### Insta-Lock™ Type C Female Coupler X Hose Shank

Size	Aluminum	Stainless Steel	Brass
1/2	C050AL	C050SS	C050BR
3/4	C075AL	C075SS	C075BR
1	C100AL	C100SS	C100BR
1 1/4	C125AL	C125SS	C125BR
1 1/2	C150AL	C150SS	C150BR
2	C200AL	C200SS	C200BR
2 1/2	C250AL	C250SS	C250BR
3	C300AL	C300SS	C300BR
4	C400AL	C400SS	C400BR
5	C500AL	C500SS	C500BR
6	C600AL	C600SS	C600BR

Size	Max. Width with Cam Arms Closed (O)	Overall Length (L)	Exposed Length (E)	Minimum ID (I)	Max. Width with Cam Arms Extended (C)
in.	in.	in.	in.	in.	in.
1/2	2.469	3.063	1.188	0.260	4.969
3/4	2.781	3.656	1.313	0.490	5.261
1	2.920	4.250	1.975	0.718	5.367
1 1/4	3.510	4.625	2.350	0.906	7.669
1 1/2	3.830	4.750	2.370	1.156	7.967
2	4.210	5.281	2.531	1.625	8.340
2 1/2	4.720	5.750	2.625	2.093	8.837
3	5.680	6.840	2.849	2.560	10.435
4	6.780	7.218	2.994	3.468	11.538
5	7.813	7.563	2.625	4.469	12.571
6	9.344	8.969	2.844	5.469	16.096

Note: Continental ContiTech Insta-Lock™ fittings are never to be used in steam or compressed air service. Continental ContiTech Products Insta-Lock™ Cam Arms are designed exclusively for Insta-Lock™ fittings.

Air & Multipurpose  
General Purpose  
Heavy Duty  
Push-on

Chemical Transfer

Cleaning Equipment

Food  
Transfer  
Washdown

Marine

Material Handling  
Abrasives  
Bulk Transfer  
Cement & Concrete

Mining

Petroleum  
Aircraft Fueling  
Dispensing  
Dock  
Transfer

Spray

Steam

Vacuum

LPG Delivery

Water  
Discharge  
Suction & Discharge  
Washdown

Welding

Coupling Systems

Equipment

Appendix

# Insta-Lock™ Type D Female Coupler X Female NPT Thread

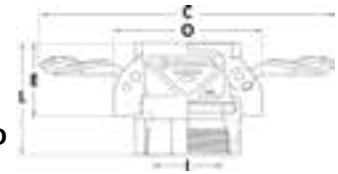

## Product Specifications

### Application

Type D fitting is commonly threaded onto a pipe, threaded hose end or manifold system, which is connected and disconnected on a regular basis. Insta-Lock™ fittings are designed for liquids and dry bulk. Consult the chemical resistance guide for specific chemical recommendations.

### Materials

Aluminum, 316# Stainless Steel and Brass

### Pressure Rating

Sizes 1/2"-2", 250 psi; sizes 2½"-4", 150 psi; sizes 5"-6", 75 psi. Recommended working pressure ratings based on ambient temperature 70°F (21°C) with Standard Nitrile gaskets.

### Branding

Example: Continental ContiTech D200SS

### Order Codes

650-828 (aluminum), 650-836 (brass),  
650-844 (stainless steel)

### Insta-Lock™ Type D Female Coupler X Female NPT Thread

Size	Aluminum	Stainless Steel	Brass
1/2	D050AL	D050SS	D050BR
3/4	D075AL	D075SS	D075BR
1	D100AL	D100SS	D100BR
1¼	D125AL	D125SS	D125BR
1½	D150AL	D150SS	D150BR
2	D200AL	D200SS	D200BR
2½	D250AL	D250SS	D250BR
3	D300AL	D300SS	D300BR
4	D400AL	D400SS	D400BR
5	D500AL	D500SS	D500BR
6	D600AL	D600SS	D600BR

Size	Max Width with CAM Arms Closed (O)	Overall Length (L)	Exposed Length (E)	Minimum ID (I)	Max Width with CAM Arms Extended (C)
in.	in.	in.	in.	in.	in.
1/2	2.469	1.813	1.188	0.656	4.969
3/4	2.781	2.063	1.313	0.813	5.261
1	2.920	2.375	1.975	1.000	5.367
1¼	3.510	2.687	2.350	1.300	7.669
1½	3.830	2.843	2.370	1.560	7.967
2	4.210	3.156	2.531	1.937	8.340
2½	4.720	3.437	2.625	2.312	8.837
3	5.680	3.718	2.849	2.937	10.435
4	6.780	4.030	2.994	3.750	11.538
5	7.813	4.313	2.563	4.688	12.571
6	9.344	4.513	2.719	5.750	16.096

Note: Continental ContiTech Insta-Lock™ fittings are never to be used in steam or compressed air service. Continental ContiTech Products Insta-Lock™ Cam Arms are designed exclusively for Insta-Lock™ fittings.

# Insta-Lock™ Type E Male Adapter X Hose Shank

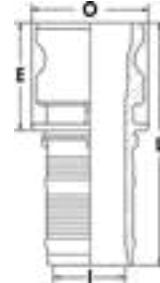

## Product Specifications

### Application

Type E fitting can be attached to a rubber hose with the use of interlocking ferrules, crimp sleeve and bands. Insta-Lock™ fittings are designed for liquids and dry bulk. Consult the chemical resistance guide for specific chemical recommendations.

### Materials

Aluminum, 316# Stainless Steel and Brass

### Pressure Rating

Sizes 1/2"-2", 250 psi; sizes 2 1/2"-4", 150 psi; sizes 5"-6", 75 psi. Recommended working pressure ratings based on ambient temperature 70°F (21°C) with Standard Nitrile gaskets.

### Branding

Example: Continental ContiTech E200SS

### Order Codes

650-829 (aluminum), 650-837 (brass),  
650-845 (stainless steel)

### Insta-Lock™ Type E Male Adapter X Hose Shank

Size	Aluminum	Stainless Steel	Brass
1/2	E050AL	E050SS	E050BR
3/4	E075AL	E075SS	E075BR
1	E100AL	E100SS	E100BR
1 1/4	E125AL	E125SS	E125BR
1 1/2	E150AL	E150SS	E150BR
2	E200AL	E200SS	E200BR
2 1/2	E250AL	E250SS	E250BR
3	E300AL	E300SS	E300BR
4	E400AL	E400SS	E400BR
5	E500AL	E500SS	E500BR
6	E600AL	E600SS	E600BR

Size	Maximum OD (O)	Overall Length (L)	Exposed Length (E)	Minimum ID (I)
in.	in.	in.	in.	in.
1/2	1.188	3.500	1.625	0.260
3/4	1.262	3.969	1.625	0.490
1	1.625	4.569	1.944	0.718
1 1/4	2.000	4.812	2.187	0.906
1 1/2	2.312	5.000	2.250	1.156
2	2.687	5.625	2.500	1.625
2 1/2	3.062	6.187	2.687	2.093
3	3.781	7.125	2.750	2.562
4	4.875	7.434	2.809	3.468
5	6.563	7.844	2.906	4.469
6	7.125	9.188	3.063	5.469

Note: Continental ContiTech Insta-Lock™ fittings are never to be used in steam or compressed air service.

Air & Multipurpose  
General Purpose  
Heavy Duty  
Push-on

Chemical Transfer

Cleaning Equipment

Food  
Transfer  
Washdown

Marine

Material Handling  
Abrasives  
Bulk Transfer  
Cement & Concrete

Mining

Petroleum  
Aircraft Fueling  
Dispensing  
Dock  
Transfer

Spray

Steam

Vacuum

LPG Delivery

Water  
Discharge  
Suction & Discharge  
Washdown

Welding

Coupling Systems

Equipment

Appendix

# Insta-Lock™ Type F Male Adapter X Male NPT Thread

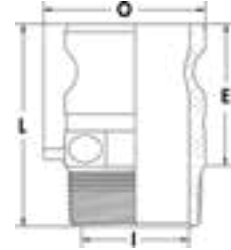

## Product Specifications

### Application

Type F fitting is normally threaded onto a pipe, or manifold connections and mated with Part C, Part B or Part D. Used in applications that require frequent connections. Insta-Lock™ fittings are designed for liquids and dry bulk. Consult the chemical resistance guide for specific chemical recommendations.

### Materials

Aluminum, 316# Stainless Steel and Brass

### Pressure Rating

Sizes 1/2"-2", 250 psi; sizes 2½"-4", 150 psi; sizes 5"-6", 75 psi. Recommended working pressure ratings based on ambient temperature 70°F (21°C).

### Branding

Example: Continental ContiTech F200SS

### Order Codes

650-830 (aluminum), 650-838 (brass),  
650-846 (stainless steel)

### Insta-Lock™ Type F Male Adapter X Male NPT Thread

Size	Aluminum	Stainless Steel	Brass
1/2	F050AL	F050SS	F050BR
3/4	F075AL	F075SS	F075BR
1	F100AL	F100SS	F100BR
1¼	F125AL	F125SS	F125BR
1½	F150AL	F150SS	F150BR
2	F200AL	F200SS	F200BR
2½	F250AL	F250SS	F250BR
3	F300AL	F300SS	F300BR
4	F400AL	F400SS	F400BR
5	F500AL	F500SS	F500BR
6	F600AL	F600SS	F600BR

Size	Max. Width Across Adapter (O)	Overall Length (L)	Exposed Length (E)	Minimum ID (I)	Distance Chain Lug Extends from BOD (C)
in.	in.	in.	in.	in.	in.
1/2	1.150	2.250	1.531	0.469	0.375
3/4	1.688	2.375	1.656	0.688	0.375
1	1.730	2.819	2.038	0.875	0.375
1¼	2.130	3.156	2.279	1.187	0.375
1½	2.300	3.222	2.347	1.437	0.375
2	2.909	3.593	2.596	1.750	0.375
2½	3.281	4.218	2.812	2.187	0.375
3	3.844	4.343	2.875	2.812	0.375
4	4.994	4.746	3.184	3.734	0.375
5	6.188	4.906	3.125	4.688	0.375
6	7.500	5.219	3.313	5.750	0.375

Note: Continental ContiTech Insta-Lock™ fittings are never to be used in steam or compressed air service. Continental ContiTech Products Insta-Lock™ Cam Arms are designed exclusively for Insta-Lock™ fittings.

# Insta-Lock™ Fittings – Reducers & Jump Sizes



## Insta-Lock™ Fittings – Reducers & Jump Sizes

Continental ContiTech SAP	Part Name	Description	Size	Material
in.	in.	in.	in.	in.
20668616	AA200AL	Spool Adapter (Male X Male)	2 X 2	Aluminum
20668617	AA300AL	Spool Adapter (Male X Male)	3 X 3	Aluminum
20668618	AA400AL	Spool Adapter (Male X Male)	4 X 4	Aluminum
20668774	DA3020AL	Jump Size Female Coupler X Male Adapter	3 X 2	Aluminum
20668775	DA3040AL	Jump Size Female Coupler X Male Adapter	3 X 4	Aluminum
20668776	DA4030AL	Jump Size Female Coupler X Male Adapter	4 X 3	Aluminum
20668777	DA6040AL	Jump Size Female Coupler X Male Adapter	6 X 4	Aluminum
20668779	DD300AL	Female Coupler X Female Coupler	3 X 3	Aluminum
20668780	DD400AL	Female Coupler X Female Coupler	4 X 4	Aluminum

**Air & Multipurpose**  
General Purpose  
Heavy Duty  
Push-on

Chemical Transfer

Cleaning Equipment

**Food**  
Transfer  
Washdown

Marine

**Material Handling**  
Abrasives  
Bulk Transfer  
Cement & Concrete

Mining

**Petroleum**  
Aircraft Fueling  
Dispensing  
Dock  
Transfer

Spray

Steam

Vacuum

LPG Delivery

**Water**  
Discharge  
Suction & Discharge  
Washdown

Welding

Coupling Systems

Equipment

Appendix

# Insta-Lock™ Interlocking Stainless Steel Male NPT Hose Stem

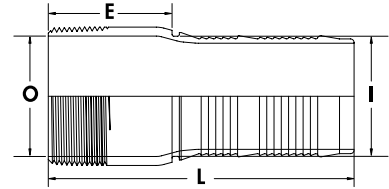

## Product Specifications

### Application

Interlocking Stainless Steel Male NPT Hose Stem fittings are designed to be attached to a rubber hose with the use of a Continental ContiTech Insta-Lock™ Ferrule. Consult the chemical resistance guide for specific chemical resistance recommendations.

### Materials

316# Stainless Steel

### Pressure Rating

Sizes 1" to 2" 250 psi, 2½" to 4" 150 psi. Recommended working pressure ratings based on ambient temperature 70°F (21°C).

### Branding

Example: Continental ContiTech GTM200SS

### Order Codes

604-824 (stainless steel)

## Insta-Lock™ Interlocking Stainless Steel Male NPT Hose Stem

Size	Stainless Steel
1	GTM100SS
1¼	GTM125SS
1½	GTM150SS
2	GTM200SS
2½	GTM250SS
3	GTM300SS
4	GTM400SS

Size	Maximum OD (O)	Overall Length (L)	Exposed Length (E)	Minimum ID (I)
in.	in.	in.	in.	in.
1	1.315	4.375	1.750	0.830
1¼	1.660	4.500	1.875	1.130
1½	1.900	4.750	2.000	1.360
2	2.375	5.250	2.125	1.820
2½	2.875	6.125	2.625	2.240
3	3.500	7.000	2.625	2.730
4	4.500	7.625	3.000	3.710

Note: Continental ContiTech Insta-Lock™ fittings are never to be used in steam or compressed air service.

Air & Multipurpose  
General Purpose  
Heavy Duty  
Push-on

Chemical Transfer

Cleaning Equipment

Food  
Transfer  
Washdown

Marine

Material Handling  
Abrasives  
Bulk Transfer  
Cement & Concrete

Mining

Petroleum  
Aircraft Fueling  
Dispensing  
Dock  
Transfer

Spray

Steam

Vacuum

LPG Delivery

Water  
Discharge  
Suction & Discharge  
Washdown

Welding

Coupling Systems

Equipment

Appendix

# Insta-Lock™ Dust Cap



## Product Specifications

### Application

Dust cap is used to seal the pipe system and hose assemblies during non-use or transfer of assembly. Mating parts are the Part A, Part E and Part F.

### Materials

Aluminum, 316# Stainless Steel and Brass (standard Nitrile gasket)

### Branding

Example: Continental ContiTech DC200SS

### Order Codes

650-831 (aluminum) 650-839 (brass)  
650-847 (stainless steel)

### Insta-Lock™ Dust Cap

Size	Aluminum	Stainless Steel	Brass
1/2	DC050AL	DC050SS	DC050BR
3/4	DC075AL	DC075SS	DC075BR
1	DC100AL	DC100SS	DC100BR
1¼	DC125AL	DC125SS	DC125BR
1½	DC150AL	DC150SS	DC150BR
2	DC200AL	DC200SS	DC200BR
2½	DC250AL	DC250SS	DC250BR
3	DC300AL	DC300SS	DC300BR
4	DC400AL	DC400SS	DC400BR
5	DC500AL	DC500SS	DC500BR
6	DC600AL	DC600SS	DC600BR

Size	Max. Width with Cam Arms Closed (O)	Overall Length (L)	OD with Cam Arms Extended (C)	Distance Chain Lug Extends from Body
in.	in.	in.	in.	in.
1/2	2.469	1.625	4.969	0.375
3/4	2.781	1.625	5.261	0.375
1	2.920	2.086	5.367	0.375
1¼	3.510	2.360	7.669	0.375
1½	3.830	2.400	7.967	0.375
2	4.210	2.633	8.340	0.375
2½	4.720	2.786	8.837	0.375
3	5.680	2.957	10.435	0.375
4	6.780	3.134	11.538	0.375
5	7.813	3.219	12.571	0.375
6	9.344	3.500	16.096	0.375

Note: Continental ContiTech Insta-Lock™ fittings are never to be used in steam or compressed air service. Continental ContiTech Insta-Lock™ Cam Arms are designed exclusively for Insta-Lock™ fittings.

Warning: Dust Caps and Dust Plugs are not to be used in pressure applications for safety and environmental reasons.

**Air & Multipurpose**  
General Purpose  
Heavy Duty  
Push-on

Chemical Transfer

Cleaning Equipment

**Food**  
Transfer  
Washdown

Marine

**Material Handling**  
Abrasives  
Bulk Transfer  
Cement & Concrete

Mining

**Petroleum**  
Aircraft Fueling  
Dispensing  
Dock  
Transfer

Spray

Steam

Vacuum

LPG Delivery

**Water**  
Discharge  
Suction & Discharge  
Washdown

Welding

Coupling Systems

Equipment

Appendix

# Insta-Lock™ Dust Plug



## Product Specifications

### Application

Dust plugs are used to seal the pipe system and hose assemblies during non-use or transfer of assembly. Mating parts are the Part C, Part B and Part D.

### Materials

Aluminum, 316# Stainless Steel and Brass

### Branding

Example: Continental ContiTech DP200SS

### Order Codes

650-832 (aluminum), 650-840 (brass),  
650-848 (stainless steel)

## Insta-Lock™ Dust Plug

Size	Aluminum	Stainless Steel	Brass
1/2	DP050AL	DP050SS	DP050BR
3/4	DP075AL	DP075SS	DP075BR
1	DP100AL	DP100SS	DP100BR
1¼	DP125AL	DP125SS	DP125BR
1½	DP150AL	DP150SS	DP150BR
2	DP200AL	DP200SS	DP200BR
2½	DP250AL	DP250SS	DP250BR
3	DP300AL	DP300SS	DP300BR
4	DP400AL	DP400SS	DP400BR
5	DP500AL	DP500SS	DP500BR
6	DP600AL	DP600SS	DP600BR

Size	Overall Length (L)	Exposed Length (E)
in.	in.	in.
1/2	1.531	0.500
3/4	1.563	0.500
1	1.843	0.469
1¼	2.125	0.469
1½	2.156	0.469
2	2.375	0.469
2½	2.437	0.469
3	2.500	0.469
4	2.559	0.469
5	2.594	0.469
6	2.781	0.469

Note: Continental ContiTech Insta-Lock™ fittings are never to be used in steam or compressed air service.

Warning: Dust Caps and Dust Plugs are not to be used in pressure applications for safety and environmental reasons.

### Air & Multipurpose

General Purpose  
Heavy Duty  
Push-on

### Chemical Transfer

### Cleaning Equipment

### Food

Transfer  
Washdown

### Marine

### Material Handling

Abrasives  
Bulk Transfer  
Cement & Concrete

### Mining

### Petroleum

Aircraft Fueling  
Dispensing  
Dock  
Transfer

### Spray

### Steam

### Vacuum

### LPG Delivery

### Water

Discharge  
Suction & Discharge  
Washdown

### Welding

### Coupling Systems

### Equipment

### Appendix



# Insta-Lock™ Repair Kits



## Product Specifications

### Application

316# Stainless Steel and Brass

### Materials

1 handle, 1 finger ring, 1 pin

### Order Codes

605-855 (stainless steel), 605-856 (brass)

### Part Number System

First 3 digits = Size

S = Stainless Steel

B = Brass

C = Continental ContiTech Insta-Lock™ Handle

M = Music Wire Ring

P = Pin

## Insta-Lock™ Repair Kits

Size	Stainless Steel Handles	Brass Handles
in.	in.	in.
1/2	050SGMP	050BGMP
3/4	100SGMP	100BGMP
1	100SGMP	100BGMP
1¼	125SGMP	125BGMP
1½	150SGMP	150BGMP
2	200SGMP	200BGMP
2½	250SGMP	250BGMP
3	300SGMP	300BGMP
4	300SGMP	300BGMP
5	300SGMP	300BGMP
6	600SGMP	600BGMP

**Air & Multipurpose**  
General Purpose  
Heavy Duty  
Push-on

Chemical Transfer

Cleaning Equipment

**Food**  
Transfer  
Washdown

Marine

**Material Handling**  
Abrasives  
Bulk Transfer  
Cement & Concrete

Mining

**Petroleum**  
Aircraft Fueling  
Dispensing  
Dock  
Transfer

Spray

Steam

Vacuum

LPG Delivery

**Water**  
Discharge  
Suction & Discharge  
Washdown

Welding

Coupling Systems

Equipment

Appendix

# Insta-Lock™ Gaskets

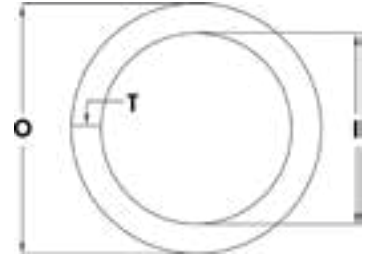

## Product Specifications

### Materials

Nitrile, Viton®, Teflon® Encapsulated Viton®, White Neoprene, Neoprene, Silicone

### Order Codes

650-849 (Nitrile), 650-850 (Viton®), 650-851 (Teflon®), 650-852 (White Neoprene), 650-853 (Neoprene), 650-854 (Silicone)

### Part Number System

G = Gasket

First 3 digits = Size of Gasket

Letters = Gasket Material Code

### Insta-Lock™ Gaskets

Size	OD (O)	ID (I)	Thickness (T)
1/2	1.031	0.688	0.156
3/4	1.375	0.875	0.218
1	1.563	1.062	0.250
1¼	1.938	1.359	0.250
1½	2.188	1.625	0.250
2	2.625	2.000	0.250
2½	3.125	2.375	0.250
3	3.719	3.000	0.250
4	4.875	4.000	0.250
5	5.906	4.875	0.250
6	7.063	6.000	0.250

Size	Nitrile	Viton	Teflon Encapsulated Viton	White Neoprene	Neoprene	Silicone
in.	in.	in.	in.	in.	in.	in.
1/2	G050BN	G050VT	G050TE	G050WN	G050NE	G050SL
3/4	G075BN	G075VT	G075TE	G075WN	G075NE	G075SL
1	G100BN	G100VT	G100TE	G100WN	G100NE	G100SL
1¼	G125BN	G125VT	G125TE	G125WN	G125NE	G125SL
1½	G150BN	G150VT	G150TE	G150WN	G150NE	G150SL
2	G200BN	G200VT	G200TE	G200WN	G200NE	G200SL
2½	G250BN	G250VT	G250TE	G250WN	G250NE	G250SL
3	G300BN	G300VT	G300TE	G300WN	G300NE	G300SL
4	G400BN	G400VT	G400TE	G400WN	G400NE	G400SL
5	G500BN	G500VT	G500TE	G500WN	G500NE	G500SL
6	G600BN	G600VT	G600TE	G600WN	G600NE	G600SL

Nitrile = BN; Black  
Teflon® = TE; White/Black with yellow stripe

Neoprene = NE; Black with red stripe  
Viton® = VT; Black with yellow stripe

White Neoprene = WN; White  
Silicone = SL; Red

Viton® is a registered trademark of DuPont Dow Elastomers L.L.C.

Teflon® is a registered trademark of E.I. du Pont de Nemours and Company.

Air &amp; Multipurpose

General Purpose

Heavy Duty

Push-on

Chemical Transfer

Cleaning Equipment

Food

Transfer

Washdown

Marine

Material Handling

Abrasives

Bulk Transfer

Cement &amp; Concrete

Mining

Petroleum

Aircraft Fueling

Dispensing

Dock

Transfer

Spray

Steam

Vacuum

LPG Delivery

Water

Discharge

Suction &amp; Discharge

Washdown

Welding

Coupling Systems

Equipment

Appendix

# Insta-Lock™ Interlocking Ferrules



## Product Specifications

### Materials

304# Stainless Steel

Plated Carbon Steel

### Part Number System

FRSS200244 or FRCS200244

FR = Ferrule; SS = Stainless Steel; CS = Plated Carbon Steel

First 3 digits = Inside Diameter of Hose

Fourth digit = Inside Diameter of Ferrule in inches.

Fifth & sixth digits = Inside Diameter of Ferrule in 64ths of an inch.

### Insta-Lock™ Interlocking Ferrules

Stainless Steel			Plated Carbon Steel				
1"	FRSS100124	2"	FRSS200232	3"	FRSS300332	1½"	FRCS150208
	FRSS100128		FRSS200236		FRSS300336		FRCS150212
	FRSS100132		FRSS200240		FRSS300340		FRCS150216
	FRSS100136		FRSS200244		FRSS300344		
	FRSS100140		FRSS200248		FRSS300348	2"	FRCS200232
			FRSS200252		FRSS300352		FRCS200236
1¼"	FRSS125144		FRSS200256		FRSS300356		FRCS200240
	FRSS125148		FRSS200260		FRSS300360		FRCS200244
	FRSS125152				FRSS300400		FRCS200248
	FRSS125156	2½"	FRSS250256		FRSS300404		
			FRSS250260			3"	FRCS300336
1½"	FRSS150156		FRSS250300	4"	FRSS400436		FRCS300340
	FRSS150160		FRSS250304		FRSS400440		FRCS300344
	FRSS150200		FRSS250308		FRSS400444		FRCS300348
	FRSS150204		FRSS250312		FRSS400448		
	FRSS150208		FRSS250316		FRSS400452	4"	FRCS400444
	FRSS150212		FRSS250320		FRSS400456		FRCS400448
	FRSS150216		FRSS150224		FRSS400460		FRCS400452
	FRSS150220				FRSS400500		
					FRSS400504		

**Air & Multipurpose**  
General Purpose  
Heavy Duty  
Push-on

Chemical Transfer

Cleaning Equipment

**Food**  
Transfer  
Washdown

Marine

**Material Handling**  
Abrasives  
Bulk Transfer  
Cement & Concrete

Mining

**Petroleum**  
Aircraft Fueling  
Dispensing  
Dock  
Transfer

Spray

Steam

Vacuum

LPG Delivery

**Water**  
Discharge  
Suction & Discharge  
Washdown

Welding

Coupling Systems

Equipment

Appendix

# Stainless Steel & Aluminum Crimp Sleeves for Infinity™/Paladin® Hoses



## Product Specifications

### Materials

304# Stainless Steel Aluminum

### Part Number System

CSSS300400

CS = Crimp Sleeves SS = Stainless Steel SAL = Aluminum

First 3 digits = Inside Diameter of Hose

Fourth digit = Inside Diameter of Sleeve in inches.

Fifth & sixth digits = Inside Diameter of Sleeve in 64ths of an inch.

### Infinity™ and Paladin® Crimp Sleeves

Size	Stainless Steel Handles	Brass Handles
in.	part #	part #
2	CSSS200300	SAL200260
3	CSSS300400	SAL300360
4	CSSS400500	SAL400460

Air & Multipurpose  
General Purpose  
Heavy Duty  
Push-on

Chemical Transfer

Cleaning Equipment

Food  
Transfer  
Washdown

Marine

Material Handling  
Abrasives  
Bulk Transfer  
Cement & Concrete

Mining

Petroleum  
Aircraft Fueling  
Dispensing  
Dock  
Transfer

Spray

Steam

Vacuum

LPG Delivery

Water  
Discharge  
Suction & Discharge  
Washdown

Welding

Coupling Systems

Equipment

Appendix

# Pressure Washer Fittings



## Product Specifications

### Application

1/4" and 3/8" bite to wire pressure washer fittings. Only for use with the following Continental ContiTech pressure washer hose specs: Fortress® 3000, Neptune™ 3000, Neptune™ 4001-R, Neptune™ 4500, Gauntlet® 3000, Gauntlet® 4500, Sani-Wash Plus® 3000, Galvanator® 3000 and Neptune™ 6000.

### Materials

Steel, yellow zinc diachromate finish

### Branding

Non-branded

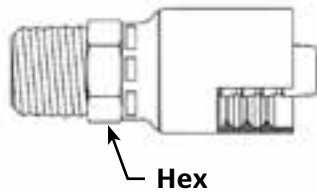

**NPTF Male Solid**

Order Code	Hose Size	Thread Size
	in.	in.
539-173-538-24000	1/4	1/4-18
539-173-538-22800	3/8	3/8-18F250BR

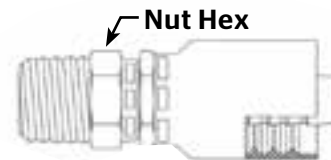

**NPTF Male Swivel**

Order Code	Hose Size	Thread Size
	in.	in.
539-173-538-23600	1/4	1/4-18
539-173-538-22900	3/8	3/8-18



**22mm Power Wash**

Order Code	Hose Size	Thread Size
	in.	in.
539-173-538-23800	3/8	22 x 1.5

**Air & Multipurpose**  
General Purpose  
Heavy Duty  
Push-on

Chemical Transfer

Cleaning Equipment

**Food**  
Transfer  
Washdown

Marine

**Material Handling**  
Abrasives  
Bulk Transfer  
Cement & Concrete

Mining

**Petroleum**  
Aircraft Fueling  
Dispensing  
Dock  
Transfer

Spray

Steam

Vacuum

LPG Delivery

**Water**  
Discharge  
Suction & Discharge  
Washdown

Welding

Coupling Systems

Equipment

Appendix

# Equipment



**Air & Multipurpose**

- General Purpose
- Heavy Duty
- Push-on

Chemical Transfer

Cleaning Equipment

**Food**

- Transfer
- Washdown

Marine

**Material Handling**

- Abrasives
- Bulk Transfer
- Cement & Concrete

Mining

**Petroleum**

- Aircraft Fueling
- Dispensing
- Dock Transfer

Spray

Steam

Vacuum

LPG Delivery

**Water**

- Discharge
- Suction & Discharge
- Washdown

Welding

Coupling Systems

Equipment

Appendix

	<b>Page</b>
PC125M	279
PC125	280
PC150	281
PC150H	282
PC200-P	283
PC400-P	284
PC600L-P	285
PC1000-P	286
PC1200-P	287
PCTB1500/2500	289

# PC125M

## Description

Carried to the job site with a handle and support stand, the PC125M is ideal for portable crimping requirements. Whether carried on-site or used in a vehicle, or even stationary at the shop, the PC125M is designed as a low-volume crimper or for occasional use. Crimp diameter is set and controlled with an easy-to-read micrometer. This affordable crimper is packaged in component parts to fit the need of the user. The PC125M has three power options. No electrical power source is required if using the hand or pneumatic pump option. A 1/2-HP, 110V electric pump is available as well. The PC125M includes die ring pusher, stand, compression ring, pressure plate and a metric micrometer. Pumps and dies are purchased separately.



PC125M

## Features

- › Easy-to-read, fully adjustable metric micrometer allows precise setting of crimp diameters to an accuracy of +/- .1mm
- › Open design with vertical feed for good operator visibility
- › Removable pusher and spring-loaded die set for easy loading
- › 60-ton cylinder
- › Two-piece, "slide in" die design for easy installation
- › Lightweight for portable field use
- › Color-coded die sets to speed die selection and setup
- › Attach hand, air or electric pump

## Capability

- › 1/4" through 1e" ID 2-braid hose and 1e" ID 4-spiral hose with all coupling end styles including most bent tubes

## Power Source

- › Optional Two Stage Hand Pump, 10,000 psi (PC125-HPump)
- › Optional Air/Hydraulic Pump, 10,000 psi using 80 psi air (PC125-PPump)
- › Optional 1/2-HP, 110V AC, single phase, 50-60 Hz Electric Pump (PC125M-.5EPump) with foot switch

**Oil Capacity:** 1 gallon

**Mounting:** Stand included

**Dimensions:** 14" L x 11" W x 23.5" H

**Weight:** 45 lbs.

## Dies

Part Number	ID	Part Number	ID
PC125 - 8.5 Black	8.5mm	PC125 - 27 Brown	27mm
PC125 - 12 Black	12mm	PC125 - 31 Silver	31mm
PC125- 1 4 Red	14mm	PC125 - 34 Purple	34mm
PC125 - 16 Blue	16mm	PC125 - 41 Orange	41mm
PC125 - 19 Green	19mm	PC125 - 45 Black	45mm
PC125 - 23 Yellow	23mm	PC125 - 50 Black	50mm

## Options

- › PC125M - Kit includes the PC125M crimper and 7 die sets including 16mm, 19mm, 23mm, 27mm, 31mm, 34mm and 41mm dies for 1/4" to 1" 1-braid and 2-braid hose
- › PC125 - Shelf-Black Die Storage Shelf 13" deep x 12.5" wide x 15" high, 12 lbs.
- › PC125 - Hpump - Two Stage Hand Pump
- › PC125 - Ppump - Air/Hydraulic Pump
- › PC125M - .5EPump - 1/2 HP, 110V Electric Pump

## Replacement Parts

- › PC125M - Pusher - Die Ring Pusher
- › PC125 - Cring - Compression Ring
- › PC125 - Pplate - Pressure Plate
- › PC125 - Die Screw - Die Screw
- › PC125 - Die Spring - Die Spring
- › PC125 - Hpump - Optional Two Stage Hand Pump
- › PC125 - Ppump - Optional Air/Hydraulic Pump
- › PC125M - .5EPump - Optional 1/2 HP, 110V Electric Pump
- › PC900 - Grease-3 oz. - High-pressure grease in a 3 oz. tube
- › PC900 - Grease-1 lb. - High-pressure grease in a 1 lb. can
- › PC900 - AerosolLube - High-pressure grease in an aerosol can



Electric Pump (PC125M-.5EPump)



Metric Micrometer



PC125 Die Set



Air/Hydraulic Pump (PC125-PPump)



PC125 Die Storage Shelf



Hand Pump (PC125-HPump)

Information in this supersedes all previously printed material and is current as of September 2014. Due to continual product improvements, Continental ContiTech reserves the right to alter specs without prior notice. For the most current product information, visit [www.contitech.us](http://www.contitech.us).

**Air & Multipurpose**  
General Purpose  
Heavy Duty  
Push-on

**Chemical Transfer**

**Cleaning Equipment**

**Food**  
Transfer  
Washdown

**Marine**

**Material Handling**  
Abrasives  
Bulk Transfer  
Cement & Concrete

**Mining**

**Petroleum**  
Aircraft Fueling  
Dispensing  
Dock  
Transfer

**Spray**

**Steam**

**Vacuum**

**LPG Delivery**

**Water**  
Discharge  
Suction & Discharge  
Washdown

**Welding**

**Coupling Systems**

**Equipment**

**Appendix**

## PC125

### Description

The PC125 portable crimper, with its open design, removable pusher and easy-to-use, spring-loaded die set, is designed for higher production volume and repetitive use. Crimp diameter is set and controlled with an easy-to-read micrometer. The PC125 is packaged for shop service and includes the crimper and 1-HP, 110V electric pump on a common base, compression ring, pressure plate, magnetized die ring pusher, stop/start remote pendant switch, metric micrometer, adjustable coupling stop and adjustable retraction stop.



PC125

### Features

- › Easy-to-read, fully adjustable metric micrometer allows precise setting of crimp diameters to an accuracy of +/-0.1mm
- › Open design with vertical feed for good operator visibility
- › Removable pusher and spring-loaded die set for easy loading
- › Magnetized pusher to attach compression ring for repetitive use
- › 60-ton cylinder
- › Automatic shutoff for precise crimps
- › Adjustable retraction stop limits ram retractions for quick repetitive crimps
- › Adjustable coupling stop for accurate, repetitive positioning of the assembly inside the dies
- › Two-piece, "slide in" die design for easy installation
- › Common base for bench mounting
- › Color-coded die sets to speed die selection and setup
- › 1-HP, 110V pump
- › Pneumatic activation (no electric wires) of remote pendant switch

### Capability

- › 1/4" through 1 1/4" ID 2-braid hose and 1 1/4" ID 4-spiral hose with all coupling end styles including most bent tubes

### Power Source

- › 1-HP, 110V AC, single phase, 50-60 Hz, Electric Pump (PC125/150-E1PUMP) with pneumatic stop/start pendant switch

**Oil Capacity:** 1 gallon

**Mounting:** Crimper and pump installed on plate

**Dimensions:** 20" L x 11" W x 19" H

**Weight:** 125 lbs.

### Dies

Part Number	ID	Part Number	ID
PC125 - 8.5 Black	8.5mm	PC125 - 27 Brown	27mm
PC125 - 12 Black	12mm	PC125 - 31 Silver	31mm
PC125 - 14 Red	14mm	PC125 - 34 Purple	34mm
PC125 - 16 Blue	16mm	PC125 - 41 Orange	41mm
PC125 - 19 Green	19mm	PC125 - 45 Black	45mm
PC125 - 23 Yellow	23mm	PC125 - 50 Black	50mm

### Options

- › PC125-Kit includes the PC125 crimper and 7 die sets including 16mm, 19mm, 23mm, 27mm, 31mm, 34mm and 41mm dies for 1/4" to 1" 1-braid and 2-braid hose
- › PC125-Shelf - Black Die Storage Shelf Unit 13" deep x 12.5" wide x 15" high, 12 lbs.

### Replacement Parts

- › PC125 - Pusher - Die Ring Pusher With Magnets
- › PC125 - Cring - Compression Ring
- › PC125 - Pplate - Pressure Plate
- › PC125 - Cstop - Adjustable Coupling Stop
- › PC125 - Die Screw - Die Screw
- › PC125 - Die Spring - Die Spring
- › PC125/150 - Switch - Pneumatic Start/Stop Pendant Switch for 1 HP Pump
- › PC125/150 - E1Pump - 1 HP 110V Electric Pump
- › PC900 - Grease-3 oz. - High-pressure grease in a 3 oz. tube
- › PC900 - Grease-1 lb. - High-pressure grease in a 1 lb. can
- › PC900 - AerosolLube-High-pressure grease in an aerosol can



Metric Micrometer



PC125 Die Storage Shelf



PC125 Die Set



PC125 Coupling Stop



PC125 Retraction Stop



PC125 Magnetic Pusher

Information in this supersedes all previously printed material and is current as of September 2014. Due to continual product improvements, Continental ContiTech reserves the right to alter specs without prior notice. For the most current product information, visit [www.contitech.us](http://www.contitech.us).

Air & Multipurpose

General Purpose

Heavy Duty

Push-on

Chemical Transfer

Cleaning Equipment

Food

Transfer

Washdown

Marine

Material Handling

Abrasives

Bulk Transfer

Cement & Concrete

Mining

Petroleum

Aircraft Fueling

Dispensing

Dock

Transfer

Spray

Steam

Vacuum

LPG Delivery

Water

Discharge

Suction & Discharge

Washdown

Welding

Coupling Systems

Equipment

Appendix



## PC150 Series Including PC150-1 & PC150-2

### Description

The PC150-2 is a stationary crimper with more power to manufacture factory-quality hose assemblies quickly and easily. Its open design with removable pusher and "slide in" die configuration allow for good visibility and easy loading of dies and hose assemblies. Crimp diameter is set and controlled with an easy-to-read micrometer. Designed to handle higher volumes in a shop environment, the PC150-2 includes the crimper and 2-HP pump on a common base, pressure plate, compression ring, die ring pusher, stop/start remote pendant switch, metric micrometer, adjustable coupling stop, adjustable retraction stop and work light. The optional PC150-1 includes all the components of the PC150-2 and a 1-HP pump.



### Features

- › Easy-to-read, fully adjustable metric micrometer allows precise setting of crimp diameters to an accuracy of +/- .1mm
- › Open design with vertical feed for good operator visibility
- › Removable pusher and spring-loaded die set for easy loading
- › 80-ton cylinder
- › Automatic shutoff for precise crimps
- › Adjustable retraction stop limits ram retractions for quick repetitive crimps
- › Adjustable coupling stop for accurate, repetitive positioning of the assembly inside the dies
- › Two-piece, "slide in" die set for easy installation
- › Common base for bench mounting
- › Color-coded die sets to speed die selection and setup
- › 2-HP, 220V pump
- › Pneumatic activation (no electric wires) of remote pendant switch

### Capability

- › 1/4" through 1½" ID 2-braid hose and 4-spiral hose with all coupling end styles including most bent tubes

### Power Source

- › 2-HP, 220V AC, single phase, 50-60 Hz Electric Pump (PC150-E2Pump) for PC150-2 crimper
- › Optional 1-HP, 110V AC, single phase, 50-60 Hz Electric Pump (PC125/150-E1Pump) for PC150-1 crimper

**Oil Capacity:** 1 gallon

**Mounting:** Crimper and pump installed on plate

**Dimensions:** 32" L x 16.5" W x 29" H

**Weight:** 275 lbs.

### Dies

Part Number	ID	Part Number	ID
PC150 - 8.5 Black	8.5mm	PC150 - 27 Brown	27mm
PC150 - 12 Black	12mm	PC150 - 31 Silver	31mm
PC150 - 14 Red	14mm	PC150 - 34 Purple	34mm
PC150 - 16 Blue	16mm	PC150 - 41 Orange	41mm
PC150 - 19 Green	19mm	PC150 - 45 Black	45mm
PC150 - 23 Yellow	23mm	PC150 - 50 Black	50mm
PC150 - 27 Brown	27mm	PC150 - 56 Black	56mm

### Options

- › PC150 - 1 Kit includes PC150-1 crimper and 7 die sets including 16mm, 19mm, 23mm, 31mm, 41mm, 50mm and 56mm dies for 1/4" to 1½" 1-braid to 4-spiral hose
- › PC150 - 2 Kit includes PC150-2 crimper and 7 die sets including 16mm, 19mm, 23mm, 31mm, 41mm, 50mm and 56mm dies for 1/4" to 1½" 1-braid to 4-spiral hose
- › PC150 - Shelf - Black Die Storage Shelf Unit 15" deep x 20.5" wide x 16" high, 25 lbs.
- › PC150 - Spacer - Spacer Kit for Elbows
- › PC150 - 1 with 1 HP Pump
- › PC150 - 2 with 2 HP Pump

### Replacement Parts

- › PC150 - Pusher - Die Ring Pusher
- › PC150 - Cring - Compression Ring
- › PC150 - Pplate - Pressure Plate
- › PC150 - Cstop - Adjustable Coupling Stop
- › PC150 - Die Screw - Die Screw
- › PC150 - Die Spring - Die Spring
- › PC125/150 - Switch - Pneumatic Start/Stop Pendant Switch for 1-HP or 2-HP Pump
- › PC150 - E2Pump - 2-HP Electric Pump for PC150-2 Crimper
- › PC125/150 - E1Pump - 1-HP Electric Pump for PC150-1 Crimper
- › PC900 - Grease-3 oz.-High-pressure grease in a 3 oz. tube
- › PC900 - Grease-1 lb.-High-pressure grease in a 1 lb. can
- › PC900-AerosolLube-High-pressure grease in an aerosol can



PC150 Coupling Stop



PC150 Die Set



PC150 Die Storage Shelf



PC150 Retraction Stop

Information in this supersedes all previously printed material and is current as of September 2014. Due to continual product improvements, Continental ContiTech reserves the right to alter specs without prior notice. For the most current product information, visit [www.contitech.us](http://www.contitech.us).

**Air & Multipurpose**  
General Purpose  
Heavy Duty  
Push-on

**Chemical Transfer**

**Cleaning Equipment**

**Food**  
Transfer  
Washdown

**Marine**

**Material Handling**  
Abrasives  
Bulk Transfer  
Cement & Concrete

**Mining**

**Petroleum**  
Aircraft Fueling  
Dispensing  
Dock  
Transfer

**Spray**

**Steam**

**Vacuum**

**LPG Delivery**

**Water**  
Discharge  
Suction & Discharge  
Washdown

**Welding**

**Coupling Systems**

**Equipment**

**Appendix**

## PC150H Series Including PC150H-1 & PC150H-2

### Description

The PC150H offers the ease of use of a horizontal crimper with the power and precise adjustment capabilities usually found in more costly models.

With the same crimping capability as the PC150 Series, the "H" model offers hose feed horizontally from either front or rear through a large 4.9 inch throat opening. The PC150H can be ordered with a 1-HP electric pump (PC150H-1) or a 2-HP electric pump (PC150H-2), producing maximum force in a small package. The PC150H makes repetitive crimps fast and easy to accomplish with a precise, direct-read digital adjustment and a built-in cylinder retraction stop. The PC150H also offers convenience features found in both our vertical and horizontal crimpers including a pneumatic start/stop pendant switch, a magnetic die change tool, an optional die rack for storing dies and master die grease fittings as a special feature for easy lubrication.



PC150H

### Features

- › Easy-to-read micrometer provides precise crimp settings
- › Hose feed is horizontal from both front and rear
- › Easy die loading with magnetic die change tool
- › Maximum die size 56mm
- › 155-ton crimping force
- › Automatic shutoff for precise crimps
- › Retraction stop limits die travel for faster repetitive crimps
- › Large 13-quart oil reservoir to cool components during repetitive crimps
- › Pneumatic activation using remote pendant switch
- › 1-HP and 2-HP power options

### Capability

- › 1/4" through 1 1/2" ID 2-braid hose and 4-spiral hose with all coupling styles and most bent tubes

### Power Source

- › 1-HP, 110V AC, single phase (PC150H-1)
- › 2-HP, 220V AC, single phase (PC150H-2)

**Oil Capacity:** 13 quarts

**Mounting:** Bench or cabinet

**Dimensions:** 15.0" L x 23.5" W x 20.5" H

**Weight:** 245 lbs.

### Dies

Part Number	ID	Part Number	ID
PC150H-8.5	8.5mm	PC150H-31	31mm
PC150H-12	12mm	PC150H-34	34mm
PC150H-14	14mm	PC150H-41	41mm
PC150H-16	16mm	PC150H-45	45mm
PC150H-19	19mm	PC150H-50	50mm
PC150H-23	23mm	PC150H-56	56mm
PC150H-27	27mm		

### Options

- › PC150H - 1 Kit includes the PC150H-1 crimper and 7 die sets including 16mm, 19mm, 23mm, 31mm, 41mm, 50mm and 56mm
- › PC150H - 2 Kit includes the PC150H-2 crimper and 7 die sets including 16mm, 19mm, 23mm, 31mm, 41mm, 50mm and 56mm
- › PC150H-Rack - Black die cabinet 7" deep x 13" wide x 18" high, holds 9 dies

### Replacement Parts

- › PC900 - Grease-1lb. - High-pressure grease in 1 lb. can
- › PC900 - AerosolLube - High-pressure grease in an aerosol can
- › PC125/150 Switch - Pneumatic Start/Stop Pendant Switch for 1 - HP or 2 - HP Pump
- › PC150H-DCT - Die Change Tool



PC150H Die Set



Die Change Tool



PC150H Die Rack



Digital Gauge

Information in this supersedes all previously printed material and is current as of September 2014. Due to continual product improvements, Continental ContiTech reserves the right to alter specs without prior notice. For the most current product information, visit [www.contitech.us](http://www.contitech.us).

Air & Multipurpose

General Purpose

Heavy Duty

Push-on

Chemical Transfer

Cleaning Equipment

Food

Transfer

Washdown

Marine

Material Handling

Abrasives

Bulk Transfer

Cement & Concrete

Mining

Petroleum

Aircraft Fueling

Dispensing

Dock

Transfer

Spray

Steam

Vacuum

LPG Delivery

Water

Discharge

Suction & Discharge

Washdown

Welding

Coupling Systems

Equipment

Appendix

## PC200-P Series including PC200-1, PC200-2 & PC200-3

### Description

The PC200-P is a high-volume, high-capacity stationary crimper utilizing microprocessor control for the fastest, most accurate crimping system available. Crimp settings, dwell time, pre-set start positions and auto/manual operation are all easily set with electronic controls. This production crimper is a quick and easy way to make factory-quality hose assemblies. The standard package is the PC200-P crimper, which includes a 7.5-HP, 230V/3 phase pump and foot pedal. The optional PC200-2 crimper includes a 7.5-HP, 480V/3 phase pump and foot pedal. The optional PC200-3 (single phase) crimper includes a 5-HP, 220V/single phase pump and foot pedal.



PC200-1

### Features

- › Hose feed is horizontal from both front or rear
- › Accurate electronic PLC crimp diameter adjustment
- › Manual or automatic model
- › Max die size +78 mm
- › 340-ton cylinder
- › Automatic shutoff for precise crimps
- › Power return stroke and return limit control
- › Rapid retraction of die fingers through hydraulic system
- › Die sets easily changed using hand tool.
- › Accommodates bent tube/elbow couplings with the ability of installing 2", 90-degree fittings on both ends

### Capability

- › 1/4" through 2" ID 2-braid hose and 2" 6-spiral hose with all coupling end styles including most bent tubes

### Power Source

- › 7.5-HP, 230V AC, 3 phase, 60 Hz (PC200-E7.5-1Pump)
- › Optional 7.5-HP, 480V AC, 3 phase, 60 Hz (PC200-E7.5-2 Pump) for the PC200-2 crimper
- › Optional 5-HP, 220V AC, single phase, 60 Hz for the PC200-3 crimper

**Oil Capacity:** 8 gallons

**Mounting:** Bench or cabinet

**Dimensions:** 18.5" L x 27.5" W x 31.5" H (without die cabinet)

**Weight:** 573 lbs. (excluding cabinet)

### Dies

Part Number	ID	Part Number	ID
PC200 - 8.5	8.5mm	PC200 - 41	41mm
PC200 - 12	12mm	PC200 - 45	45mm
PC200 - 14	14mm	PC200 - 50	50mm
PC200 - 16	16mm	PC200 - 56	56mm
PC200 - 19	19mm	PC200 - 62	62mm
PC200 - 23	23mm	PC200 - 69	69mm
PC200 - 27	27mm	PC200 - 74	74mm
PC200 - 31	31mm	PC200 - 78	78mm
PC200 - 34	34mm		

### Options

- › PC200-P - 1 Kit includes the PC200-1 crimper and 10 die sets including 16mm, 19mm, 23mm, 31mm, 41mm, 50mm, 56mm, 62mm, 69mm and 78mm dies for 1/4" to 2" 1-braid to 6-spiral hose
- › PC200 - 2 Kit includes the PC200-2 crimper and 10 die sets including 16mm, 19mm, 23mm, 31mm, 41mm, 50mm, 56mm, 62mm, 69mm and 78mm dies for 1/4" to 2" 1-braid to 6-spiral hose
- › PC200 - 3 Kit includes the PC200-3 crimper and 10 die sets including 16mm, 19mm, 23mm, 27mm, 31mm, 34mm, 41mm, 50mm, 56mm and 69mm
- › PC200 - Rack - Black Die Cabinet 20" deep x 30" wide x 29" high
- › PC200 - MBS - Manual Back Stop
- › PC200 - EBS - Electric Back Stop

### Replacement Parts

- › PC900 - Grease-1lb. - High-pressure grease in a 1 lb. can
- › PC900 - AerosolLube - High-pressure grease in an aerosol can



PC200 Die Set



Optional Automatic Back Stop



Control Panel



Foot Switch



Die Cabinet

**Air & Multipurpose**  
General Purpose  
Heavy Duty  
Push-on

**Chemical Transfer**

**Cleaning Equipment**

**Food**  
Transfer  
Washdown

**Marine**

**Material Handling**  
Abrasives  
Bulk Transfer  
Cement & Concrete

**Mining**

**Petroleum**  
Aircraft Fueling  
Dispensing  
Dock  
Transfer

**Spray**

**Steam**

**Vacuum**

**LPG Delivery**

**Water**  
Discharge  
Suction & Discharge  
Washdown

**Welding**

**Coupling Systems**

**Equipment**

**Appendix**

Information in this supersedes all previously printed material and is current as of September 2014. Due to continual product improvements, Continental ContiTech reserves the right to alter specs without prior notice. For the most current product information, visit [www.contitech.us](http://www.contitech.us).

## PC400-P Series Including PC400-P & PC400-1P

**Air & Multipurpose**

General Purpose  
Heavy Duty  
Push-on

**Chemical Transfer**

**Cleaning Equipment**

**Food Transfer Washdown**

**Marine**

**Material Handling**

Abrasives  
Bulk Transfer  
Cement & Concrete

**Mining**

**Petroleum**

Aircraft Fueling  
Dispensing  
Dock Transfer

**Spray**

**Steam**

**Vacuum**

**LPG Delivery**

**Water Discharge Suction & Discharge Washdown**

**Welding**

**Coupling Systems**

**Equipment**

**Appendix**

**Description**

The PC400-P is a high-volume, high-capacity stationary crimper utilizing microprocessor control for the fastest, most accurate crimping system available. Crimp settings, dwell time, pre-set start positions and auto/manual operation are all easily set with electronic controls. This production crimper is a quick



PC400

and easy way to make both hydraulic and industrial hose assemblies. The standard package is the PC400-P crimper which includes a 7.5-HP, 230V/3 phase pump and foot pedal. The optional PC400-1 crimper includes a 5-HP, 230V/single phase pump and foot pedal.

**Features**

- › Hose feed is horizontal from both front or rear
- › Accurate electronic PLC crimp diameter adjustment
- › Manual or automatic model
- › Maximum die opening: die closed diameter + 78mm (hydraulic) and 122mm (industrial)
- › 265-ton cylinder
- › Automatic shutoff for precise crimps
- › Power return stroke and return limit control
- › Rapid retraction of die fingers through hydraulic system
- › Die sets easily changed using hand tool
- › Accommodates bent tube/elbow couplings with the ability of installing 2", 90-degree fittings on both ends

**Capability**

- › 1/4" through 2" ID 2-braid hose, and 2" 6-spiral hose and 4" industrial hose with all coupling end styles including most bent tubes
- › 1/2" through 4" ID industrial hose

**Power Source**

- › 7.5-HP, 230V AC, 3 phase, 60 Hz for the PC400 crimper
- › Optional 5-HP, 230V AC, single phase for the PC400-1 crimper

**Oil Capacity:** 8 gallons

**Mounting:** Bench or cabinet

**Dimensions:** 18.5" L x 27.5" W x 31.5" H (without die cabinet)

**Weight:** 573 lbs. (excluding cabinet)

**Hydraulic Dies (PC400 utilizes PC200 dies)**

Part Number	ID	Part Number	ID
PC200 - 8.5	8.5mm	PC200 - 34	34mm
PC200 - 12	12mm	PC200 - 41	41mm
PC200 - 14	14mm	PC200 - 45	45mm
PC200 - 16	16mm	PC200 - 50	50mm
PC200 - 19	19mm	PC200 - 56	56mm
PC200 - 23	23mm	PC200 - 62	62mm
PC200 - 27	27mm	PC200 - 69	69mm
PC200 - 31	31mm	PC200 - 74	74mm
		PC200 - 78	78mm

**Industrial Dies**

Part Number	ID	Part Number	ID
PC400 - 86-125L	86mm	PC400-114-125L	114mm
PC400 - 90-125L	90mm	PC400-118-125L	118mm

**Options**

- › PC400 - Kit includes the PC400 crimper and 12 die sets including 16mm, 19mm, 23mm, 27mm, 31mm, 34mm, 41mm, 50mm, 56mm, 62mm, 69mm and 78mm dies for 1/4" to 2" 1-braid to 6-spiral hose
- › PC400 - 1 Kit includes the PC400-1 crimper and 12 die sets including 16mm, 19mm, 23mm, 27mm, 31mm, 34mm, 41mm, 50mm, 56mm, 62mm, 69mm and 78mm dies for 1/4" to 2" 1-braid to 6-spiral hose
- › PC200 - Rack - Black Die Cabinet 20" deep x 30" wide x 29" high
- › PC200 - MBS - Manual Back Stop
- › PC200 - EBS - Electric Back Stop

**Replacement Parts**

- › PC900 - Grease -1lb. High-pressure grease in a 1 lb. can
- › PC900 - AerosolLube - High-pressure grease in an aerosol can



Control Panel



Foot Switch



Die Cabinet



Optional Automatic Back Stop

Information in this supersedes all previously printed material and is current as of September 2014. Due to continual product improvements, Continental ContiTech reserves the right to alter specs without prior notice. For the most current product information, visit [www.contitech.us](http://www.contitech.us).

## PC600L-P Crimper

### Description

The PC600L-P is a high-volume, high-capacity stationary crimper utilizing the fully automatic ACT3™ microprocessor controller. The PC600L-P can produce 2,200 crimps per hour with 350 tons of crimping force to allow for both hydraulic and industrial hose assemblies, and it is ideal for production assembly applications. The standard PC600L-P crimper includes a 7.5-HP, 230 VAC, 3-phase hydraulic pump.

### Features

- › Fully automatic ACT3™ controller
- › Manual and automatic operation
- › Utilizes the PC200/400 dies with easy-to-change die tool
- › 350-ton cylinder
- › Built-in heavy-duty base with die holders
- › Allows for 2,200 crimps per hour
- › Automatic shutoff for precise crimps
- › Power return stroke and return limit control

### Capability

- › 1/4" through 2.5" ID, 2-braid and 6-spiral hydraulic hose
- › 3/16" through 6" ID industrial hose

### Power Source

- › 7.5-HP, 230V AC, 3 phase, 60 Hz

### Dimensions

- › Master die inside diameter - 145mm
- › Master die opening w/o dies - 273mm
- › Maximum swaging diameter - 192mm
- › Maximum die opening - Die+128mm
- › Pump size: 21" L x 34" W x 36.5" H
- › Pump weight: 450 lbs. (205kg)
- › Machine size: 22" L x 36" W x 57" H

**Weight:** 4,500 lbs. (2,041kg) die base/cabinet (shipping weight)

The following dies are included in the standard PC600-P Kit

### Hydraulic Dies

SAP #	Descriptive #	Description
20244976	PC200-16	16mm Die
20244977	PC200-19	19mm Die
20244978	PC200-23	23mm Die
20244980	PC200-31	31mm Die
20244982	PC200-41	41mm Die
20244984	PC200-50	50mm Die
20244985	PC200-56	56mm Die
20244986	PC200-62	62mm Die
20244987	PC200-69	69mm Die
20249890	PC200-78	78mm Die



PC600



Optional Automatic Back Stop

### Continental ContiTech Part Numbers

SAP #	Descriptive #	Description
20527520	PC600-P Skit	PC600-P Kit 16-23, 31, 41, 50, 56, 62, 69, 78  Includes Hydraulic & Industrial Dies (Hyd: 16-23, 31, 41, 50, 56, 62, 69, 79) (Ind: 84, 92, 100, 125, 166, 178)
20548773	PC600-P Skit H&I	
20267266	PC200/400-DCT	Die Change Tool
20244972	PC200-EBS	Electric Back Stop (Optional)
20244971	PC200-MBS	Manual Back Stop

**Air & Multipurpose**  
General Purpose  
Heavy Duty  
Push-on

Chemical Transfer

Cleaning Equipment

**Food**  
Transfer  
Washdown

Marine

**Material Handling**  
Abrasives  
Bulk Transfer  
Cement & Concrete

Mining

**Petroleum**  
Aircraft Fueling  
Dispensing  
Dock  
Transfer

Spray

Steam

Vacuum

LPG Delivery

**Water**  
Discharge  
Suction & Discharge  
Washdown

Welding

Coupling Systems

**Equipment**

Appendix

## PC1000-P Crimper

**Air & Multipurpose**

- General Purpose
- Heavy Duty
- Push-on

Chemical Transfer

Cleaning Equipment

**Food**

- Transfer
- Washdown

Marine

**Material Handling**

- Abrasives
- Bulk Transfer
- Cement & Concrete

Mining

**Petroleum**

- Aircraft Fueling
- Dispensing
- Dock Transfer

Spray

Steam

Vacuum

LPG Delivery

**Water**

- Discharge
- Suction & Discharge
- Washdown

Welding

Coupling Systems

Equipment

Appendix

**Description**

The PC1000-P is a high-volume, high-capacity stationary crimper utilizing the fully automatic ACT3™ microprocessor controller. The PC1000-P can produce 1,415 crimps per hour with 450 tons of crimping force to allow for both Hydraulic and Industrial hose assemblies, ideal for production assembly applications. The standard PC1000-P crimper includes a 7.5-HP, 230 VAC, 3-phase hydraulic pump.

**Features**

- › Fully automatic ACT3™ controller
- › Manual and automatic operation
- › Utilizes the PC200/400 dies with easy-to-change die tool
- › 350-ton cylinder
- › Built-in heavy-duty base with die holders
- › Allows for 1,415 crimps per hour
- › Automatic shutoff for precise crimps
- › Power return stroke and return limit control

**Capability**

- › Up through 2½" ID, 2-braid, 4-spiral and 6-spiral hydraulic hose
- › 3/16" through 10" ID industrial hose

**Power Source**

- › Standard: 7.5-HP, 230 VAC, 3 Phase, 60 Hz
- › Optional: 7.5-HP, 460 VAC, 3 Phase, 60 Hz

**Dimensions**

- › Master die inside diameter - 230mm
- › Master die opening w/o dies - 350mm
- › Maximum swaging diameter - 192mm
- › Maximum die opening - Die+125mm
- › Machine size: 30" L x 44" W x 74" H

**Weight:** 6,185 lbs. (2,806kg)

**Continental ContiTech Part Numbers**

SAP #	Descriptive #	Description
20588181	PC1000-PX Kit	PC1000-PX Kit

(3 phase 230V dies 14-245) PC1000 utilizes PC200/400/600 dies and change tool



PC1000

The following dies are included in the standard PC1000-PX Kit

**Hydraulic Dies**

SAP #	Descriptive #	Description
20244975	PC200-14	14mm Die
20244976	PC200-16	16mm Die
20244977	PC200-19	19mm Die
20244978	PC200-23	23mm Die
20244980	PC200-31	31mm Die
20244982	PC200-41	41mm Die
20244984	PC200-50	50mm Die
20244985	PC200-56	56mm Die
20244986	PC200-62	62mm Die
20244987	PC200-69	69mm Die
20249890	PC200-78	78mm Die
20562098	PC600-84	84mm Die
20562099	PC600-92	92mm Die
20562650	PC600-100	100mm Die
20562651	PC600-108	108mm Die
20562652	PC600-116	116mm Die
20562653	PC600-126	126mm Die
20590712	PC1000-166	166mm Die
20590713	PC1000-178	178mm Die
20590714	PC1000-215	215mm Die
20590715	PC1000-245	245mm Die

## PC1200-P Industrial Crimper

The PC1200-P can be operated in manual mode for a single crimp or set up for fully automatic production crimping.

- › Hose capacity from 3 inch up to 14 inches industrial hose
- › The PC1200-P crimper opens to 19¼ inches permitting special and angled fittings to be handled easily
- › 7.5 HP dual stage pump
- › Industrial crimp calculator
- › Fully adjustable crimp diameter
- › Manual or automatic ACT™ controls
- › Enter crimp diameter in either inch or metric
- › Store frequently used dies and crimp settings in memory
- › Complete range of dies and accessories available

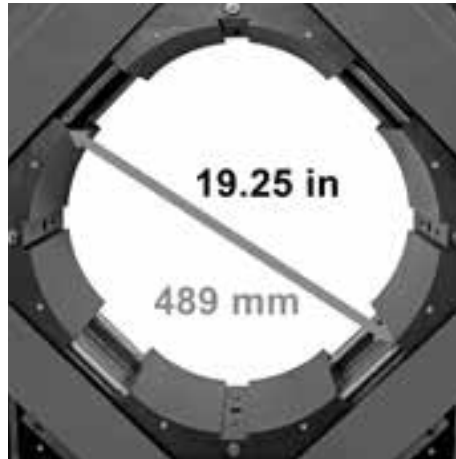

Maximum opening: 19.25 inches/489 mm

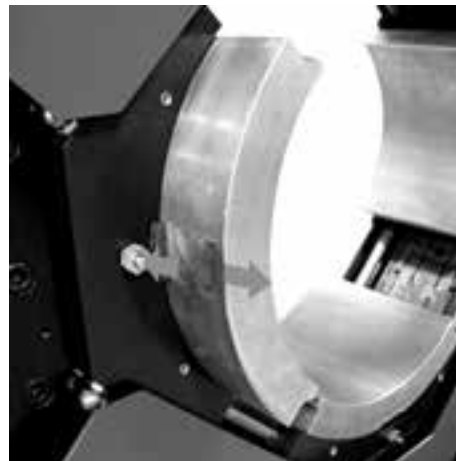

Quick Release Die

**Air & Multipurpose**  
General Purpose  
Heavy Duty  
Push-on

Chemical Transfer

Cleaning Equipment

**Food**  
Transfer  
Washdown

Marine

**Material Handling**  
Abrasives  
Bulk Transfer  
Cement & Concrete

Mining

**Petroleum**  
Aircraft Fueling  
Dispensing  
Dock  
Transfer

Spray

Steam

Vacuum

LPG Delivery

**Water**  
Discharge  
Suction & Discharge  
Washdown

Welding

Coupling Systems

Equipment

Appendix

## PC1200-P Industrial Crimper

**Air & Multipurpose**

General Purpose

Heavy Duty

Push-on

Chemical Transfer

Cleaning Equipment

**Food**

Transfer

Washdown

Marine

**Material Handling**

Abrasives

Bulk Transfer

Cement & Concrete

Mining

**Petroleum**

Aircraft Fueling

Dispensing

Dock

Transfer

Spray

Steam

Vacuum

LPG Delivery

**Water**

Discharge

Suction & Discharge

Washdown

Welding

Coupling Systems

Equipment

Appendix

**The patented ACT™ Crimp Controller**

- › Can store up to 50 dies and 150 crimp settings
- › Pressure Transducer monitors crimping "effort" eliminating "trial and error" crimping
- › Can track number of crimps and automatically pause for quality check at preset interval
- › Automatically converts inch to mm and mm to inch so that no calculation is ever required

**Technical Specifications**

Maximum Head Opening w/o Dies	489mm (19.25 in.)
Master Die Inside Diameter	381mm (15 in.)
Maximum Die Opening	152mm
Crimper Size	30 in. wide x 44 in. deep x 74 in. high
Weight with Oil	6185 lbs
Electrical Requirements	230 Volt 3 Phase (Standard) 440-480 Volt 3 Phase (Optional)
Motor	7.5 HP (1 Stage Pump) (Standard) 10 HP (Optional)
Reservoir Capacity	45 US Gal
Oil Type	ISO 46 Hydraulic Oil
Adapter Dies	381-275mm and 275-160mm
Hose Capacity	12 in. Industrial

The 7½ HP pump and electronics are housed in a separate cabinet and are easily accessible for maintenance

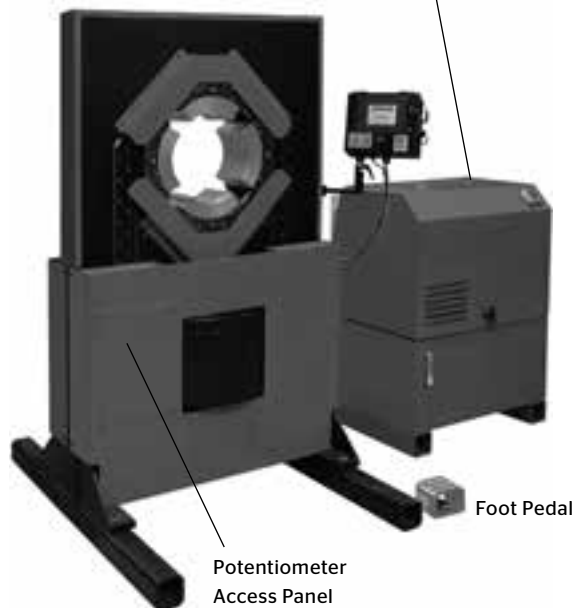

ACT™ Control Module





## PCTB1500 / PCTB2500

### Description

Continental ContiTech PCTB Series Test Benches provide a safe and efficient method to test hose assemblies for burst or proof testing.

### Features

- › Optional electronic model with programmable control including paper printout
- › 1/2" polycarbonate safety window
- › Safety lock to prevent operation when door is not closed
- › Standard garden hose inlet for water supply
- › Factory air inlet supply, 85 psi min. required
- › Powder-coated finish for durability
- › Polyurethane bed liner material coating on interior
- › 7-port outlet manifold for multiple testing
- › Built-in work light for good visibility during testing

### Capability

- › PCTB1500 - Test pressure range to 21,500 psi (1500 bar)
- › PCTB2500 - Test pressure range to 37,500 psi (2500 bar)

### Power Source

- › Standard 110 VAC, Single Phase Grounded Outlet

### Dimensions

- › Interior: 18" H x 35" W x 71" L
- › Includes test bench legs - test area at a convenient working height
- › Full opening allows for hose assemblies to be loaded on a skid

**Weight:** 750 lbs.

### Continental ContiTech Part Numbers

SAP #	Descriptive #
20439763	PCTB-1500 Test Bench
20439764	PCTB-1500 PLC Test Bench
20554088	PCTB-2500 Test Bench
20554089	PCTB-2500 PLC Test Bench



PCTB1500

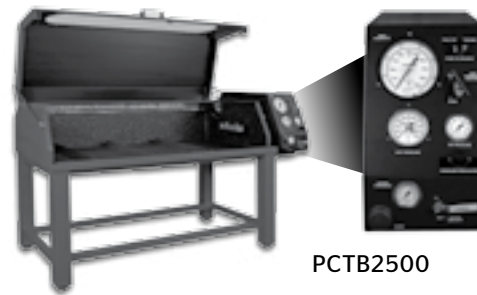

PCTB2500

**Air & Multipurpose**  
General Purpose  
Heavy Duty  
Push-on

Chemical Transfer

Cleaning Equipment

**Food**  
Transfer  
Washdown

Marine

**Material Handling**  
Abrasives  
Bulk Transfer  
Cement & Concrete

Mining

**Petroleum**  
Aircraft Fueling  
Dispensing  
Dock  
Transfer

Spray

Steam

Vacuum

LPG Delivery

**Water**  
Discharge  
Suction & Discharge  
Washdown

Welding

Coupling Systems

Equipment

Appendix

# Additional Products

## Additional Non-Stock Specifications

Order Code	Hose Description	Application
<b>Air &amp; Multipurpose</b>		
General Purpose		
Heavy Duty Push-on		
<b>Chemical Transfer</b>		
<b>Cleaning Equipment</b>		
<b>Food Transfer Washdown</b>		
<b>Marine</b>		
<b>Material Handling</b>		
Abrasives		
Bulk Transfer		
Cement & Concrete		
Mining		
<b>Petroleum</b>		
Aircraft Fueling		
Dispensing		
Dock Transfer		
Spray		
Steam		
Vacuum		
LPG Delivery		
<b>Water Discharge Suction &amp; Discharge Washdown</b>		
Welding		
<b>Coupling Systems</b>		
<b>Equipment</b>		
<b>Air &amp; Multipurpose</b>		
549-406	Plicord Green EC Air	400 psi wrapped finish Green Air hose, Class B Nitrile tube, Green SBR Class C cover
549-153	Ortac II	200 psi air hose, Class A Nitrile static dissipating tube, Red Class B cover
549-007	Plicord Air Yellow	300 psi air hose, Class C non-conductive tube, Yellow Class C cover
549-260	Plicord Rock Drill	400-500 psi air hose, Class C tube, Blue with Yellow stripe Class C cover
563-599	Ultrabraid Air	400 psi air hose, Class C tube, Class C
536-600		non-conductive MSHA cover in Green or Yellow
539-158	Ultrabraid Bull Hose	500 psi air hose, Class C tube, Yellow Class C cover
536-589	Ultrabraid HD Plus	400 psi air hose, Class A Nitrile tube
536-598		Class A Yellow or Green MSHA cover
539-156	Ultrabraid Supreme	1000 psi air hose, Class A Nitrile tube, Class A
539-157		Yellow or Blue high abrasion resistant MSHA cover
<b>Chemical</b>		
549-014	Brown Chem-Acid Discharge	Chemrin tube, versatile chemical discharge hose capable of handling a wide variety of industrial chemicals
546-014	Fabchem ARC	Pliosyn tube, Fabchem with a ARC (Abrasion-Resistant Cover) for a wide variety of industrial chemicals
546-011	Gray Chem-Acid Discharge	Weatherex tube, versatile chemical discharge hose capable of handling a wide variety of industrial chemicals
546-067	Gray Flexwing	Weatherex tube, versatile chemical transfer hose capable of handling a wide variety of industrial chemicals
546-064	Yellow Flexwing	Hysunite tube, versatile chemical transfer hose capable of handling a wide variety of industrial chemicals
546-010	Yellow Chem-Acid Discharge	Hysunite tube, versatile chemical discharge hose capable of handling a wide variety of industrial chemicals
<b>Cleaning Equipment</b>		
539-132	Neptune 2250	Pressure washer service application
539-141	Neptune 3600	Pressure washer service application
<b>Food</b>		
549-147	White Flextra	Lightweight, flexible hose for transferring oily and non-oily edibles under pressure on tank truck or in-plant service
549-150	White Softwall	Discharge transfer of dry or liquid foods having either oily or non-oily bases
539-404	Sani-Wash Plus 1000	Food washdown applications
539-413	Sani-Wash Plus 3000	Food washdown applications
<b>Marine</b>		
586-454	Spiraflex Marine Bilge	PVC hose for drain, vanity and scooper lines
586-447	Spiraflex Marine Livewell	PVC hose for head intake, discharge and pump out service
586-439	Spiraflex Marine Sanitation FDA	PVC hose for potable water transfer
586-451	Spiraflex Marine Vacuum	PVC hose for bilge pumps or holding tank pump out service
586-444	Spiraflex Marine Vacuum FDA	PVC hose for potable water transfer
<b>Material Handling</b>		
549-946	Concrete Vibrator Hose	Reinforced rubber sleeve for concrete vibrator
541-262	Clam Jetting	Softwall hose for underwater jetting and collection of clams

# Additional Products

## Additional Non-Stock Specifications

Order Code	Hose Description	Application
549-859	Blast Hole Slurry/Dewatering	Hardwall hose for filling blast hole with explosive
<b>Material Handling (continued)</b>		
541-814	Plicord Hydrovator Red S&D	Corrugated SBR cover and red natural rubber tube provide good flexibility, durability and outstanding abrasion and tear resistance
549-337	Liquid Mud Hose	Transfer Drilling Mud
549-706	Refractory Hose, 2 Plies	Refractory hose with static dissipating tube
549-863	Gunite, 4 Plies	Sand cement gunning application with static dissipation tube
586-479	Mulchblower	PVC hose for transfer of mulch products
586-477	Barkblower	PVC heavy-duty hose for transfer of wood chips
Cust Serv	Air Seeder	PVC hose for agricultural seeding applications
<b>Mining</b>		
549-229	Plicord Cable Cover Hose	Non-conductive hose for cooling/protection of electrical cables
<b>Petroleum</b>		
532-390	LT Redwing Fuel Oil	Improved flexibility at lower temperatures
541-593	Dock Hose Nitrile FDA	Large bore hose for food products
543-485	Floater Fuel Delivery (Marathon)	Softwall fuel discharge for ship to shore transfer
541-606	Smooth Bore Hot Tar & Asphalt	Hardwall hose with a smooth reinforced line for high-temp applications
541-688	Smooth Bore Molten Sulphur	Hardwall hose with a smooth reinforced liner for high-temp applications
543-142	Black Flextra II 150	Corrugated petroleum-based product transfer hose where aromatic content exceeds 50%
541-579	Plicord Rough Bore Dock	For the transfer of petroleum products between docks and ships
543-802	Plicord LW Northern Petroleum	Lighter weight petroleum-based product transfer hose where aromatic content does not exceed 50%
543-663	Infinity HD LT Petroleum Transfer	Lightweight and flexible properties with improved cold weather capabilities to -40°F /-40°C.
543-509	Plicord Vapor Recovery	Recovering gasoline vapors while unloading tank trucks at service stations or loading tanks at bulk terminals
586-425	Spiraflex Vapor Recovery	PVC hose for vapor recovery
Cust Serv	Oil Rig Supply Hose	Specialized hose lines for use on offshore drilling platforms
<b>Gasoline Dispensing</b>		
532-388	Hardwall Dispensing - Europe	Wire braid gasoline dispensing, meets European Standard EN 1360
532-387	Textile Dispensing - Australian	Textile braid gasoline dispensing, meets Australian Standard AS 2683
532-357	Hardwall Dispensing - Australian	Wire braid gasoline dispensing, meets Australian Standard AS 2683
586-425	Spiraflex Vapor Recovery	PVC hose for vapor recovery
<b>Special Application</b>		
541-219	Fish Suction	Heavy-duty hardwall hose with an abrasive liner
541-320	Furnace coolant hose	Large diameter hose for water cooling in blast furnaces
Cust Serv	Manure line hose	Delivery of manure from holding tanks to field
542-956	Radiator Hose (Standard)	Coolant hose, EPDM tube, EPDM cover, 2 plies
542-957	Radiator Hose (Heavy Duty)	Coolant hose, EPDM tube, EPDM cover, 4 plies
541-843	Plicord Paper Machine Suction Box	Flexible connection on the suction box of paper machines

**Air & Multipurpose**  
General Purpose  
Heavy Duty  
Push-on

Chemical Transfer

Cleaning Equipment

**Food**  
Transfer  
Washdown

Marine

**Material Handling**  
Abrasives  
Bulk Transfer  
Cement & Concrete

Mining

**Petroleum**  
Aircraft Fueling  
Dispensing  
Dock  
Transfer

Spray

Steam

Vacuum

LPG Delivery

**Water**  
Discharge  
Suction & Discharge  
Washdown

Welding

Coupling Systems

Equipment

Appendix

# Additional Products

## Additional Non-Stock Specifications

Order Code	Hose Description	Application
541-301	Plicord Leaf Collector	For street cleaning equipment to remove debris
<b>Special Application (continued)</b>		
542-683	Plicord Roof Drain - Nitrile	Handling rainwater drainage from floating tank roof
542-901	Plicord Roof Drain - Viton	Handling rainwater drainage from floating tank roof
Cust Serv	Air Seeder	PVC hose for agricultural seeding applications
586-402	PVC Fish Suction	PVC hose for transfer of fish
549-806	Irrigation pivot joint (boot)	Flexible joint for joining piping
586-476	Fire Engine Suction	PVC hose for water transfer service (clear with black helix)
536-461	Freon Charging GY5	Air-conditioning refrigeration hose (colors: blue/red/yellow)
536-303	Freon Charging All Rubber	Air-conditioning refrigeration hose (colors: blue/red/yellow)
536-486	Divers Hose High Pressure	High pressure diving hose application
536-451	Divers Hose Low Pressure	Low pressure diving hose application
<b>Water</b>		
586-452	Premier	Medium-duty suction and discharge hose for use in agricultural, construction and general industrial service
542-157	Plicord Contractors S&D	Water suction & discharge hose, SBR tube and cover
542-547	Jetting & Utility	High pressure water service
542-445	Potable Water 150 psi	Potable water, white natural FDA tube
542-162	Plicord Water Discharge-300 psi	General purpose water discharge hose for heavier duty applications
542-322	Plicord Water & Suction-300 psi	General purpose water S&D hose for heavier duty applications
537-512	Spiraflex 3000 (black)	PVC Lay flat for wheel line irrigation service
<b>Military</b>		
569-536	ZZ H 500C	General shop service pneumatic hose
569-567	ZZ H 601E	General water and potable water discharge service
Cust Serv	ZZ H 601E	General water and potable water discharge service
543-811	Mil PRF 370H Type A	Fuel transfer standard collapsible
543-760	Mil PRF 370H Type B	Fuel transfer standard noncollapsible
543-552	Mil DTL-6615 Type I	Fuel transfer hose with low-temperature capability, with electrical bond
543-553	Mil DTL-6615 Type II	Fuel transfer hose with low-temperature capability, without electrical bond
Cust Serv	ZZ H 561K	Water suction and discharge hose
543-766	Mil H 2224OF Type A	Lightweight fuel hose for alongside service
543-769	Mil H 2224OF Type C	Lightweight fuel/water discharge hose for alongside service
Cust Serv	Mil PRF 11588G	Fuel discharge hose style ST only
Cust Serv	Mil H 82127 Type A	Fuel discharge hose for aviation gasoline, diesel, and automotive fuels
549-749	Mil H 24136/4	Sound attenuation hose
547-855	Mil H 8788C	For use in hydraulic systems
536-341	Mil H 24580SH	Onboard ship firefighting hose

# Chemical Charts

## Continental ContiTech Chemical Resistance Chart Ratings and Definitions

**The Continental ContiTech Chemical Resistance Chart is to be used as a guide only.**

- A** The chemical is expected to have minor or no effect on the product. Product may be used for continuous service. Changes in working conditions, such as concentration of the chemical or temperature, may affect product performance and cause degradation of the product.
- B** The product may be used for continuous or intermittent service, however the product properties will be affected by the exposure to the chemical. Changes in working conditions, such as concentration of the chemical or temperature, may affect product performance and cause degradation of the product.
- X** The product should not be used with this chemical.
- I** Insufficient or no data available for this chemical. Further testing is recommended to determine compatibility of the chemical with the product.

**Caution:** Unless otherwise specified, the ratings applied to tube stocks are based on fully concentrated or saturated solutions at 100°F (38°C) under normal service conditions.

**Note:** Hose ratings are for the effect on the polymer only. The degree of resistance of a rubber compound to a specific chemical depends on many variables such as temperature, concentration, length of exposure, stability of chemical, etc. For a specific compound, many grades of polymers are available which can alter the compound's chemical resistance.

**WHEN IN DOUBT,** before using a specific product, contact your local Continental ContiTech Sales Representative for assistance if unusual service conditions or high temperatures are present in the product application.

**This chemical resistance chart supersedes all previously published information regarding Continental ContiTech chemical hose resistance ratings.**

**Air & Multipurpose**  
General Purpose  
Heavy Duty  
Push-on

Chemical Transfer

Cleaning Equipment

**Food**  
Transfer  
Washdown

Marine

**Material Handling**  
Abrasives  
Bulk Transfer  
Cement & Concrete

Mining

**Petroleum**  
Aircraft Fueling  
Dispensing  
Dock  
Transfer

Spray

Steam

Vacuum

LPG Delivery

**Water**  
Discharge  
Suction & Discharge  
Washdown

Welding

Coupling Systems

Equipment

Appendix

# Chemical Charts

<b>Air &amp; Multipurpose</b>
General Purpose
Heavy Duty
Push-on
<b>Chemical Transfer</b>
<b>Cleaning Equipment</b>
<b>Food</b>
Transfer
Washdown
<b>Marine</b>
<b>Material Handling</b>
Abrasives
Bulk Transfer
Cement & Concrete
<b>Mining</b>
<b>Petroleum</b>
Aircraft Fueling
Dispensing
Dock
Transfer
Spray
Steam
Vacuum
LPG Delivery
<b>Water</b>
Discharge
Suction & Discharge
Washdown
Welding
Coupling Systems
Equipment
Appendix

Common Name & Description	Continental ContiTech Trade Name	Continental ContiTech Product Examples with Polymer in the Tube
UHMWPE (Ultra High Molecular Weight Polyethylene)	Pliosyn	Fabchem
Butyl (Isobutylene and Isoprene)	Weatherex	Gray Flexwing
Hypalon (Chlorosulfonated Polyethylene)	Hysunite	Yellow Flexwing
NR - Natural Rubber (Isoprene, natural)	Pureten	Tan Flexwing
Viton	Flosyn	Orange Flexwing
Nitrile		Flexwing Petroleum
CPE (Chlorinated Polyethylene)	Chemrin	Brown Flexwing, ExtremeFlex Brown
EPDM (Ethylene Propylene Diene)	EPDM	Purple Flexwing, ExtremeFlex Purple
EPDM (Heat Resistant)	Pyrosyn	Flexsteel 250 Steam, Whitewater
Cross-Link Polyethylene (XLPE)	Speclar	Blue Flexwing, Green XLPE
Alphasyn (Modified Cross-Link Polyethylene)	Alphasyn	Viper
Teflon		Hi-Per Insta-Lock
316 Stainless Steel		Insta-Lock
Aluminum		Insta-Lock
Brass		

Caution: This chart and the following chemical resistance charts are intended to reflect the various tube compounds as they pertain to Continental ContiTech petroleum and chemical hose. Always use a Continental ContiTech petroleum or chemical hose when the hose is to be used for conveyance of petroleum or chemicals. Consult the following pages for chemical compatibility of the various tube stocks.

Hypalon® is a registered trademark of DuPont Dow Elastomers L.L.C.

Viton® is a registered trademark of DuPont Dow Elastomers L.L.C.

Teflon® is a registered trademark of E.I. du Pont de Nemours and Company.

# Chemical Charts

### Rating Scale

**A** = May be used for Continuous Service      **B** = May be used for Intermittent Service  
**I** = Insufficient data, contact Customer Service      **X** = Do not use

### Gasket

**T** = Teflon®      **N** = Neoprene      **V** = Viton®  
**S** = Silicone      **B** = Nitrile

Continental ContiTech Chemical Hose / Hose Tube Polymer													Insta-Lock™ Fitting/Metal			
Temp. (°F)*	Fabchem UHMWPE	Gray Flexwing Butyl	Yellow Flexwing Hypalon	Tan Flexwing NR	Orange Flexwing Viton	Flexwing Petroleum Nitrile	Brown Flexwing & ExtremeFlex Brown CPE	Purple Flexwing & ExtremeFlex Purple EPDM	Blue Flexwing & Green XLPE XLPE	Chem One & Viper Alphasyn	HIPER Teflon	316 SS	Aluminum	Brass	Gasket	
<b>A</b>																
Acetaldehyde	100	B	B	X	X	X	X	I	A	A	A	A	A	B	X	TS
Acetic Acid, Conc.	100	A	A	X	B	X	X	A	A	A	A	A	A	B	X	T
Acetic Acid, Dilute 10	150	B	A	X	A	X	X	A	A	A	A	A	A	I	X	TVN
Acetic Acid, Glacial	100	A	B	X	X	X	X	A	A	A	A	A	A	B	X	TS
Acetic Aldehyde	100	A	B	X	X	X	X	I	A	A	A	A	A	B	X	T
Acetic Anhydride	100	B	A	B	X	X	X	A	A	A	A	A	A	B	X	TS
Acetic Ester	100	B	B	X	X	X	X	B	A	A	A	A	A	A	A	TV
Acetic Ether	100	B	B	X	X	X	X	B	A	A	A	A	A	A	A	T
Acetic Oxide	100	B	A	B	X	X	X	A	A	A	A	A	A	B	X	T
Acetone	100	A	A	X	B	X	X	A	A	A	A	A	A	A	I	T
Acetone Cyanohydrin	100	B	A	X	X	X	X	A	A	A	A	A	I	I	I	TS
Acetyl Acetone	100	B	B	X	X	X	X	B	I	A	A	A	I	B	I	T
Acetyl Chloride	100	B	X	X	X	B	X	A	B	B	A	A	B	X	A	TV
Acetyl Oxide	100	B	A	B	X	X	X	A	A	A	A	A	A	B	X	T
Acetylene (dry)	100	A	A	A	A	A	A	A	A	A	X	A	A	I	I	TVBNS
Acetylene Dichloride	100	B	X	X	X	A	X	I	I	A	X	A	I	A	X	TV
Acetylene Tetrachloride	100	B	X	X	X	A	X	I	I	A	I	A	A	X	X	TV
Acrolein	100	B	A	B	B	A	B	I	I	A	A	A	I	I	I	TV
Acrylic Acid	100	B	X	X	X	A	X	X	X	A	A	A	A	I	I	TV
Acrylonitrile	100	B	X	X	X	X	X	A	X	B	A	A	A	X	I	T
Alk-Tri	100	I	X	X	X	A	X	I	I	A	I	A	A	I	I	TV
Allyl Alcohol	100	A	A	A	A	B	A	A	A	A	A	A	A	I	A	TBN
Allyl Bromide	100	B	X	X	X	B	X	B	I	B	I	A	I	I	I	T
Allyl Chloride	100	B	X	X	X	B	X	B	X	B	I	A	A	X	X	TS
Alum	150	A	A	A	A	A	A	A	A	A	A	A	A	I	X	TVBNS
Aluminum Acetate	100	A	A	A	X	X	X	A	A	A	A	A	A	I	X	T
Aluminum Chloride	150	A	A	A	A	A	A	A	A	A	A	A	I	I	X	TVB
Aluminum Formate	100	A	B	X	X	X	X	I	I	A	A	A	I	I	I	T
Aluminum Hydroxide	150	A	A	B	A	X	B	A	A	A	A	A	A	I	X	TS
Aluminum Sulfate	150	A	A	A	A	A	A	A	A	A	A	A	A	X	X	TVBNS
Aminoethanol	100	A	A	B	B	I	B	A	I	A	A	A	A	B	I	TBN
Aminoethylethanolamine	100	A	A	B	B	I	B	A	A	A	A	A	I	I	I	T
Ammonia	---	<b>No Hose Recommended For This Application</b>														
Ammonia Cupric Sulfate	150	A	A	A	X	A	A	A	A	A	A	A	A	I	I	TVB
Ammonium Chloride	150	A	A	A	A	A	A	A	A	A	A	A	A	X	X	TVBN
Ammonium Hydroxide	150	A	A	B	A	X	X	A	X	A	A	A	A	X	I	TNS
Ammonium Nitrate	150	<b>Special Hose Required</b>														
Ammonium Phosphate	150	A	A	A	A	A	A	A	A	A	A	A	A	X	X	TVBNS
Ammonium Sulfate	150	A	A	A	A	A	X	A	A	A	A	A	A	X	X	TVNS

\* Fahrenheit to Celsius conversion key: 100°F (38°C), 125°F (52°C), 150°F (66°C), 275°F (135°C) and 500°F (260°C).

This chemical chart is offered as a guide only. There are many variables to be considered with each application. Ratings are for tube polymer only! For explanation of ratings see the initial page of these Chemical Charts in Appendix B. Contact Customer Service for chemicals or polymers not listed at 800-235-4632.

# Chemical Charts

### Rating Scale

**A** = May be used for Continuous Service

**B** = May be used for Intermittent Service

**I** = Insufficient data, contact Customer Service

**X** = Do not use

### Gasket

**T** = Teflon®

**N** = Neoprene

**V** = Viton®

**S** = Silicone

**B** = Nitrile

Continental ContiTech Chemical Hose / Hose Tube Polymer													Insta-Lock™ Fitting/Metal			
Temp. (°F)*	Fabchem UHMWPE	Gray Flexwing Butyl	Yellow Flexwing Hypalon	Tan Flexwing NR	Orange Flexwing Viton	Flexwing Petroleum Nitrile	Brown Flexwing & ExtremeFlex Brown CPE	Purple Flexwing & ExtremeFlex Purple EPDM	Blue Flexwing & Green XLPE XLPE	Chem One & Viper Alphasyn	HIPER Teflon	316 SS	Aluminum	Brass	Gasket	
<b>A</b>																
Ammonium Sulfide	150	A	A	A	A	A	X	A	A	A	A	A	A	X	X	TVN
Ammonium Sulfite	150	A	A	A	A	A	A	A	A	A	A	A	A	X	I	TVBN
Ammonium Thiosulfate	100	A	A	A	A	A	A	A	A	A	A	A	B	X	TVBN	
Amyl Acetate	100	A	A	B	X	X	X	B	A	A	A	A	A	I	T	
Amyl Alcohol	100	A	A	A	A	B	A	A	A	A	A	A	I	A	TBNS	
Amyl Chloride	100	A	X	X	X	A	X	X	A	B	A	A	X	I	T V	
Amyl Oleate	100	A	X	X	X	I	B	I	A	I	A	I	I	I	T	
Amyl Phenol	100	A	X	X	X	A	X	I	A	I	A	I	I	I	T V	
Amyl Phthalate	100	A	A	X	X	X	X	I	A	I	A	I	I	I	T	
Amylamine	100	A	B	X	X	X	X	B	X	A	I	A	I	I	T	
Anethole	100	X	X	X	X	B	X	X	I	X	I	A	I	I	T	
Anhydrous Ammonia	---	<b>No Hose Recommended For This Application</b>														
Aniline	100	A	A	X	X	A	X	B	A	A	A	A	B	X	T V	
Animal Grease	100	A	X	X	X	A	A	B	X	A	A	A	A	I	TVB	
Animal Oils	100	A	B	X	X	A	A	A	X	A	B	A	A	I	TVB	
Antimony Pentachloride	100	A	X	X	X	I	X	I	X	B	B	A	I	I	T	
Aqua Ammonia	150	A	A	B	A	A	B	B	B	A	A	A	X	I	T V	
Aromatic Spirits	100	A	X	X	X	A	X	I	X	A	I	A	A	I	T V	
Aromatic Tar	100	A	X	X	X	A	X	B	X	A	I	A	I	I	T V	
Arquads	100	A	A	A	A	A	A	A	A	A	A	A	I	I	TVB	
Arsenic Acid	100	A	A	A	A	I	X	A	A	A	A	A	X	X	TVS	
Arsenic Chloride	100	I	X	X	X	X	X	X	X	X	X	A	I	I	T N	
Arsenic Trichloride	100	I	X	X	X	X	X	X	X	X	X	A	X	I	T N	
Asphalt	500	<b>Special Hose Required</b>														
ASTM #1 Oil	100	A	X	B	X	A	A	A	X	A	A	A	A	A	I	TVBNS
ASTM #2 Oil	100	A	X	X	X	A	A	A	X	A	A	A	A	A	TVB	
ASTM #3 Oil	100	A	X	X	X	A	A	A	X	A	A	A	A	A	TVB	
<b>B</b>																
Barium Carbonate	150	A	A	A	A	A	A	A	A	A	A	A	A	X	I	TVBN
Barium Chloride	150	A	A	A	A	A	A	A	A	A	A	A	A	X	I	TVBN
Barium Hydroxide	150	A	A	A	A	B	A	A	A	A	A	A	X	X	TBNS	
Barium Sulfate	150	A	A	A	A	A	A	A	A	A	A	B	A	X	TVBS	
Barium Sulfide	150	A	A	A	A	A	A	A	A	A	A	A	X	X	TVBS	
Benzal Chloride	100	A	B	I	I	I	X	X	I	A	I	A	B	X	I	T
Benzaldehyde	100	A	B	X	X	X	X	X	B	A	B	A	A	B	I	T
Benzene (Benzol)	100	A	X	X	X	A	X	X	X	B	B	A	A	A	T V	
Benzine (Ligroin)	100	A	X	X	X	A	A	I	X	A	B	A	A	A	TVB	
Benzine Solvent (Ligroin)	100	A	X	X	X	A	A	I	X	A	I	A	A	A	TVBS	

\* Fahrenheit to Celsius conversion key: 100°F (38°C), 125°F (52°C), 150°F (66°C), 275°F (135°C) and 500°F (260°C).

This chemical chart is offered as a guide only. There are many variables to be considered with each application. Ratings are for tube polymer only! For explanation of ratings see the initial page of these Chemical Charts in Appendix B. Contact Customer Service for chemicals or polymers not listed at 800-235-4632.



# Chemical Charts

### Rating Scale

**A** = May be used for Continuous Service  
**B** = May be used for Intermittent Service  
**I** = Insufficient data, contact Customer Service  
**X** = Do not use

### Gasket

**T** = Teflon®  
**S** = Silicone  
**N** = Neoprene  
**B** = Nitrile  
**V** = Viton®

	Continental ContiTech Chemical Hose / Hose Tube Polymer												Insta-Lock™ Fitting/Metal				
	Temp. (°F)*	Fabchem UHMWPE	Gray Flexwing Butyl	Yellow Flexwing Hypalon	Tan Flexwing NR	Orange Flexwing Viton	Flexwing Petroleum Nitrile	Brown Flexwing & ExtremeFlex Brown CPE	Purple Flexwing & ExtremeFlex Purple EPDM	Blue Flexwing & Green XLPE XLPE	Chem One & Viper Alphasyn	HIPER Teflon	316 SS	Aluminum	Brass	Gasket	
<b>B</b>																	
Benzoic Acid	100	A	B	B	X	I	I	A	B	A	A	A	B	B	X	TVN	
Benzoic Aldehyde	100	A	B	X	X	X	X	X	B	A	I	A	A	I	B	T	
Benzotrichloride	100	X	I	I	I	I	X	X	X	X	X	A	I	I	I	T	
Benzoyl Chloride	100	X	I	I	I	I	X	X	X	B	X	A	B	I	I	T	
Benzyl Acetate	100	A	A	B	X	X	X	B	I	A	B	A	B	I	I	T	
Benzyl Alcohol	100	A	A	X	X	A	X	A	X	A	A	A	A	B	I	TVS	
Benzyl Chloride	100	A	X	X	X	A	X	X	X	A	I	A	A	X	X	TV	
Bichromate of Soda	150	A	A	X	I	I	I	I	I	A	A	A	I	I	I	T	
Black Sulfate Liquor	150	A	X	B	B	B	B	A	B	A	A	A	A	X	X	TVBN	
Black Sulfate Liquor	275	X	X	X	X	X	X	A	X	X	X	A	A	X	X	T	
Bleach	100	X	B	X	X	B	X	I	A	X	B	A	X	X	X	TV	
Brine	150	A	A	A	A	A	A	A	A	A	A	A	A	X	I	TVBNS	
Bromine	100	X	X	X	X	B	X	I	X	X	X	A	X	X	X	TV	
Bromo Benzene	100	B	X	X	X	B	X	X	X	X	X	A	I	I	I	TV	
Bromo Toluene	100	X	X	X	X	B	X	X	X	X	X	A	I	I	I	T	
Bromochloromethane	100	X	B	X	X	B	X	X	I	X	A	A	A	X	X	T	
Bunker C.	100	B	X	X	X	A	A	I	X	A	B	A	A	I	I	TVB	
Bunker Oil	100	B	X	X	X	A	A	I	X	X	B	A	A	I	I	TVB	
Butanol	100	A	A	A	A	B	A	A	A	A	A	A	A	I	I	TBN	
Butyl (Normal) Alcohol	100	A	A	A	A	B	A	A	A	A	A	A	A	I	I	TBN	
Butyl (Secondary) Alcohol	100	A	A	A	A	B	A	A	A	A	A	A	A	I	I	TBN	
Butyl Acetate	100	A	A	B	X	X	X	B	B	A	B	A	A	B	I	T	
Butyl Acetoacetate	100	A	X	X	X	X	X	X	I	A	B	A	I	I	I	T	
Butyl Acrylate	100	B	X	X	X	X	X	B	X	B	B	A	I	I	I	T	
Butyl Alcohol	100	A	A	A	A	B	A	A	A	A	A	A	A	I	I	TBN	
Butyl Aldehyde	100	A	B	X	X	X	X	B	X	A	B	A	X	A	X	T	
Butyl Amine	100	A	B	X	X	X	X	B	X	A	B	A	A	A	I	T	
Butyl Benzene	100	A	X	X	X	A	X	X	X	A	B	A	I	I	I	TV	
Butyl Benzl Phthalate	100	A	A	X	X	X	X	I	I	A	I	A	I	I	I	T	
Butyl Bromide	100	B	X	X	X	B	X	X	X	B	B	A	I	I	I	T	
Butyl Butyrate	100	B	X	X	X	X	X	X	I	B	I	A	I	I	I	TV	
Butyl Carbitol	100	A	A	A	X	I	X	A	B	A	A	A	I	I	I	T	
Butyl Cellosolve	100	A	A	A	X	X	X	A	A	X	A	A	A	A	X	T	
Butyl Chloride	100	B	X	X	X	A	X	X	I	B	I	A	B	I	I	TV	
Butyl Ether	100	A	X	B	X	X	B	A	X	A	A	A	A	I	I	T	
Butyl Ethyl Acetaldehyde	100	A	B	X	X	X	X	I	I	A	B	A	I	I	I	T	
Butyl Ethyl Ether	100	A	X	B	X	I	B	I	X	A	A	A	I	I	I	T	

\* Fahrenheit to Celsius conversion key: 100°F (38°C), 125°F (52°C), 150°F (66°C), 275°F (135°C) and 500°F (260°C).

This chemical chart is offered as a guide only. There are many variables to be considered with each application. Ratings are for tube polymer only! For explanation of ratings see the initial page of these Chemical Charts in Appendix B. Contact Customer Service for chemicals or polymers not listed at 800-235-4632.

# Chemical Charts

### Rating Scale

**A** = May be used for Continuous Service      **B** = May be used for Intermittent Service  
**I** = Insufficient data, contact Customer Service      **X** = Do not use

### Gasket

**T** = Teflon®      **N** = Neoprene      **V** = Viton®  
**S** = Silicone      **B** = Nitrile

	Continental ContiTech Chemical Hose / Hose Tube Polymer												Insta-Lock™ Fitting/Metal			
	Temp. (°F)*	Fabchem UHMWPE	Gray Flexwing Butyl	Yellow Flexwing Hypalon	Tan Flexwing NR	Orange Flexwing Viton	Flexwing Petroleum Nitrile	Brown Flexwing & ExtremeFlex Brown CPE	Purple Flexwing & ExtremeFlex Purple EPDM	Blue Flexwing & Green XLPE XLPE	Chem One & Viper Alphasyn	HIPER Teflon	316 SS	Aluminum	Brass	Gasket
<b>B</b>																
Butyl Phthalate	100	A	A	X	X	X	X	I	I	A	A	A	A	A	I	T
Butyl Stearate	100	A	X	X	X	I	A	B	X	A	B	A	A	A	A	TBS
Butylate	100	A	I	I	I	I	I	I	A	I	I	I	I	I	I	I
Butyraldehyde	100	A	B	X	X	X	X	B	X	A	B	A	X	A	X	T
Butyric Acid	100	A	X	B	X	I	X	A	B	A	A	A	A	B	I	T
Butyric Anhydride	100	A	X	B	X	I	X	I	I	A	I	A	I	I	I	T
<b>C</b>																
Cadmium Acetate	100	A	A	A	X	X	X	A	I	A	A	A	I	I	I	T
Calcium Acetate	100	A	A	A	X	X	X	A	A	A	A	A	A	I	I	TB
Calcium Aluminate	100	A	A	A	A	A	A	A	A	A	A	A	I	I	I	TVB
Calcium Bichromate	150	X	A	X	I	I	I	I	I	X	I	A	I	I	I	T
Calcium Bisulfate	150	A	A	A	A	A	A	A	A	A	A	A	A	X	X	TVBN
Calcium Bisulfite	150	A	A	A	A	A	A	A	A	I	A	A	A	X	X	TVBNS
Calcium Carbonate	150	A	A	A	A	A	A	A	A	A	A	A	A	I	X	TVBNS
Calcium Chloride	150	A	A	A	A	A	A	A	A	A	A	A	B	X	X	TVBNS
Calcium Hydroxide (Caustic Lime)	100	A	A	B	A	X	B	A	A	A	A	A	A	X	X	TNS
Calcium Hypochlorite	100	B	B	X	X	B	X	A	B	X	A	A	A	X	X	T V
Calcium Nitrate	150	A	A	A	A	A	A	A	A	A	A	A	B	X	X	TVBN
Calcium Silicate	150	A	A	A	A	A	A	A	A	A	A	A	I	A	I	TVBN
Calcium Sulfate	150	A	A	A	A	A	A	A	A	A	A	A	A	I	I	TVBS
Calcium Sulfhydrate	100	A	A	A	A	A	A	A	A	A	A	A	I	I	I	TVB
Calcium Sulfide	150	A	A	A	A	A	A	A	A	A	A	A	A	X	X	TVBN
Calcium Sulfite	150	A	A	A	X	A	A	A	A	A	A	A	B	B	X	TVBNS
Caprylic Acid	100	A	X	B	X	I	X	A	I	A	A	A	B	I	X	T
Carbitol	100	A	A	A	X	I	X	A	A	A	A	A	B	A	X	T
Carbitol Acetate	100	A	B	B	X	I	X	I	I	A	A	A	I	I	I	T
Carbolic Acid, Phenol	100	A	A	X	X	A	X	A	X	A	B	A	A	B	A	T V
Carbon Dioxide	100	A	A	A	A	A	A	A	A	A	A	A	A	B	I	TVBNS
Carbon Disulfide	---	<b>No Hose Recommended For This Application</b>														
Carbon Tetrachloride	100	B	X	X	X	A	X	X	X	A	B	A	A	I	I	T V
Carbonic Acid	100	A	A	A	A	A	A	A	A	A	A	A	A	B	B	TVBS
Casinghead Gasoline	100	B	X	X	X	A	A	B	X	B	B	A	I	I	I	TVB
Caster Oil (Castor Oil)	100	A	A	A	X	A	A	A	A	A	A	A	A	A	I	TVBS
Caustic Potash	150	A	A	B	A	X	B	A	B	A	A	A	A	X	X	T
Caustic Soda	150	A	A	B	A	X	B	A	A	A	A	A	A	X	X	TNS
Cellosize	100	A	A	X	X	I	X	I	I	A	A	A	I	I	I	T
Cellosolve	100	A	A	A	X	X	X	I	A	A	A	A	A	A	X	T
Cellosolve Acetate	100	A	B	B	X	X	X	X	B	A	A	A	A	I	X	T

\* Fahrenheit to Celsius conversion key: 100°F (38°C), 125°F (52°C), 150°F (66°C) and 500°F (260°C).

This chemical chart is offered as a guide only. There are many variables to be considered with each application. Ratings are for tube polymer only! For explanation of ratings see the initial page of these Chemical Charts in Appendix B. Contact Customer Service for chemicals or polymers not listed at 800-235-4632.

# Chemical Charts

**Rating Scale**

**A** = May be used for Continuous Service      **B** = May be used for Intermittent Service  
**I** = Insufficient data, contact Customer Service      **X** = Do not use

**Gasket**

**T** = Teflon®      **N** = Neoprene      **V** = Viton®  
**S** = Silicone      **B** = Nitrile

Continental ContiTech Chemical Hose / Hose Tube Polymer													Insta-Lock™ Fitting/Metal				
Temp. (°F)*	Fabchem UHMWPE	Gray Flexwing Butyl	Yellow Flexwing Hypalon	Tan Flexwing NR	Orange Flexwing Viton	Flexwing Petroleum Nitrile	Brown Flexwing & ExtremeFlex Brown CPE	Purple Flexwing & ExtremeFlex Purple EPDM	Blue Flexwing & Green XLPE XLPE	Chem One & Viper Alphasyn	HIPER Teflon	Insta-Lock™ Fitting/Metal					
												316 SS	Aluminum	Brass	Gasket		
<b>C</b>																	
Chloroacetic Acid	100	A	X	X	B	X	X	A	X	A	A	A	A	X	X	X	T
Chlorinated Solvents	100	B	X	X	X	A	X	B	X	A	I	A	B	X	A	T	V
Chlorine (Dry) (Gas)	---	<b>No Hose Recommended For This Application</b>															
Chlorine (Wet)	100	X	X	X	X	B	X	X	X	X	X	A	X	X	X	T	V
Chloroacetone	100	A	I	X	X	X	X	X	X	A	I	A	A	X	X	T	
Chlorobenzene	100	B	X	X	X	A	X	X	X	A	B	A	A	B	I	T	V
Chlorobenzol	100	A	X	X	X	A	X	I	X	A	B	A	A	B	I	T	V
Chlorobutane	100	X	X	X	X	A	X	X	I	X	I	A	I	I	I	T	V
Chloroethylbenzene	100	A	X	X	X	A	X	I	X	A	I	A	I	I	I	T	V
Chloroform	100	B	X	X	X	B	X	X	X	X	B	A	A	B	I	T	V
Chloropentane	100	A	X	X	X	A	X	X	X	A	I	A	A	X	I	T	V
Chlorophenol	100	A	X	X	X	B	X	X	X	X	B	A	I	I	I	T	V
Chloropropanone	100	A	I	X	X	X	X	X	X	A	I	A	I	I	I	T	
Chlorosulfonic Acid	100	X	X	X	X	X	X	I	X	X	X	A	B	X	X	T	
Chlorothene	100	X	X	X	X	A	X	I	X	A	I	A	A	I	I	T	V
Chlorotoluene	100	X	X	X	X	A	X	X	X	X	I	A	A	I	I	T	V
Chlorpyrifos	100	I	I	I	I	I	I	I	X	I	I	I	I	I	I	I	I
Chromic Acid 25%	100	B	X	B	X	I	X	A	X	X	B	A	B	X	X	T	V
Coal Oil	100	A	X	X	X	A	A	A	X	A	A	A	A	X	A	TVB	
Coal Tar	100	A	X	X	X	A	X	B	X	A	A	A	A	I	I	TVS	
Coal Tar Naptha	100	A	X	X	X	A	X	B	X	A	A	A	A	A	I	T	V
Copper Chloride	100	A	A	A	X	A	A	A	A	A	A	A	X	X	X	TVBNS	
Copper Hydrate	100	A	A	B	X	X	B	I	I	A	A	A	I	I	I	T	B
Copper Hydroxide	100	A	A	B	X	X	B	I	I	A	A	A	I	I	I	T	B
Copper Nitrate	100	A	A	A	X	A	A	A	A	A	A	A	A	X	X	TVBNS	
Copper Nitrite	100	A	A	A	X	A	A	A	A	A	A	A	I	I	I	TVB	
Copper Sulfate	100	A	A	A	X	A	A	A	A	A	A	A	A	X	X	TVBNS	
Copper Sulfide	100	A	A	A	X	A	A	A	A	A	A	A	I	I	I	TVB	
Creosols	100	A	A	X	X	A	X	A	X	A	B	A	A	I	X	T	V
Creosote	100	A	X	X	X	A	B	I	X	A	B	A	A	I	I	T	V
Cresylic Acid	100	A	A	X	X	I	X	X	X	A	I	A	A	B	X	T	V
Crotonaldehyde	100	A	A	X	X	X	X	A	I	A	A	A	I	I	I	T	
Crude Oil	100	A	X	X	X	A	A	B	X	A	B	A	A	A	I	TVB	
Cumene	100	A	X	X	X	A	X	X	X	A	B	A	I	I	I	T	V
Cupric Carbonate	100	A	A	A	X	A	A	A	A	A	A	A	I	I	I	TVBN	
Cupric Chloride	100	A	A	A	X	A	A	A	A	A	A	A	B	X	I	TVBNS	
Cupric Nitrate	100	A	A	A	X	A	A	A	A	A	A	A	B	I	I	TVBN	
Cupric Nitrite	100	A	A	A	X	A	A	A	A	A	A	A	I	I	I	TVB	
Cupric Sulfate	100	A	A	A	X	A	A	A	A	A	A	A	I	I	I	TVBNS	
Cyclohexane	100	A	X	X	X	A	B	A	X	A	B	A	A	B	X	T	V

\* Fahrenheit to Celsius conversion key: 100°F (38°C), 125°F (52°C), 150°F (66°C), 275°F (135°C) and 500°F (260°C).

This chemical chart is offered as a guide only. There are many variables to be considered with each application. Ratings are for tube polymer only! For explanation of ratings see the initial page of these Chemical Charts in Appendix B. Contact Customer Service for chemicals or polymers not listed at 800-235-4632.

# Chemical Charts

**Rating Scale**

**A** = May be used for Continuous Service

**B** = May be used for Intermittent Service

**I** = Insufficient data, contact Customer Service

**X** = Do not use

**Gasket**

**T** = Teflon®

**N** = Neoprene

**V** = Viton®

**S** = Silicone

**B** = Nitrile

Continental ContiTech Chemical Hose / Hose Tube Polymer													Insta-Lock™ Fitting/Metal			
Temp. (°F)*	Fabchem UHMWPE	Gray Flexwing Butyl	Yellow Flexwing Hypalon	Tan Flexwing NR	Orange Flexwing Viton	Flexwing Petroleum Nitrile	Brown Flexwing & ExtremeFlex Brown CPE	Purple Flexwing & ExtremeFlex Purple EPDM	Blue Flexwing & Green XLPE XLPE	Chem One & Viper Alphasyn	HIPER Teflon	316 SS	Aluminum	Brass	Gasket	
<b>C</b>																
Cyclohexanol	100	A	X	X	X	B	B	A	X	A	B	A	A	X	X	TVB
Cyclohexanone	100	A	X	X	X	X	X	X	X	A	B	A	A	I	I	T
Cyclopentane	100	A	X	X	X	A	B	B	X	A	B	A	I	I	I	TVN
Cyclopentane, methyl	100	A	X	X	X	A	B	I	X	A	B	A	I	I	I	TV
Cyclopentanol	100	A	X	X	X	B	B	A	X	A	A	A	I	I	I	TVB
Cyclopentanone	100	A	X	X	X	X	X	X	X	A	B	A	I	I	I	T
<b>D</b>																
D.D.T. in Kerosene	100	A	X	X	X	A	A	A	X	A	B	A	I	I	A	TVB
D.M.P.	100	X	X	X	X	X	X	X	X	X	A	A	A	I	I	TV
Decalin	100	X	X	X	X	A	X	X	X	A	X	A	I	I	I	TV
Decanol	100	A	A	A	X	B	A	A	A	A	A	A	I	I	I	TB
Decyl Alcohol	100	A	A	A	X	B	A	A	A	A	A	A	I	I	I	TB
Decyl Aldehyde	100	A	X	X	X	X	X	I	I	A	B	A	I	I	I	T
Decyl Butyl Phthalate	100	A	A	X	X	X	X	I	I	A	I	A	I	I	I	T
Denatured Alcohol	100	A	A	A	A	B	A	A	A	A	A	A	A	B	A	TB
Diacetone Alcohol	100	A	A	B	B	X	X	A	X	A	A	A	A	I	I	T
Diamyl Phenol	100	A	X	X	X	A	X	A	X	A	I	A	I	I	I	TV
Diamylamine	100	A	A	X	B	I	B	A	I	A	B	A	I	I	I	TB
Diamylene	100	A	X	X	X	A	X	B	X	A	B	A	I	I	I	TV
Dibenzyl Ether	100	A	B	X	X	I	X	X	X	A	B	A	A	A	X	T
Dibromobenzene	100	B	X	X	X	A	X	I	X	A	I	A	I	I	I	TV
Dibutyl Amine	100	A	X	X	B	X	B	A	X	A	A	A	I	I	I	T
Dibutyl Ether	100	A	X	B	X	X	X	A	X	A	A	A	A	A	X	T
Dibutyl Phthalate	100	A	A	X	X	X	X	X	A	A	A	A	A	A	I	TV
Dibutyl Sebacate	100	A	A	X	X	X	X	B	X	A	I	A	I	I	I	TVS
Dicalcium Phosphate	100	A	A	A	A	A	A	A	A	A	A	A	I	I	I	TVB
Dicamba	100	A	I	I	I	I	I	I	A	A	I	A	I	I	I	T
Dichloroacetic Acid	100	A	X	X	B	X	X	B	I	A	I	A	I	I	I	T
Dichlorobenzene	100	A	X	X	X	A	X	X	X	A	B	A	A	B	I	TV
Dichlorobutane	100	A	X	X	X	A	X	X	X	A	I	A	I	I	I	TV
Dichlorodifluoromethane	100	I	X	X	X	B	B	I	X	I	X	A	I	I	I	TVB
Dichloroethane	100	A	X	X	X	A	X	X	X	A	A	A	I	A	I	TV
Dichloroethyl Ether	100	A	X	X	X	I	X	B	X	A	B	A	I	I	I	T
Dichloroethylene	100	X	X	X	X	A	X	I	I	X	X	A	I	A	X	TV
Dichlorohexane	100	A	X	X	X	A	X	X	X	A	A	A	I	I	I	TV
Dichloropentane	100	A	X	X	X	A	X	X	X	A	B	A	I	I	I	TV
Dichloropropane	100	A	X	X	X	A	X	X	X	B	I	A	A	X	I	TV
Diesel Oil	150	A	X	X	X	A	A	A	X	A	B	A	A	A	I	TVB
Diethanol Amine	100	A	A	X	B	I	B	A	I	A	A	A	A	I	I	T
Diethyl Benzene	100	A	X	X	X	A	X	X	X	A	B	A	I	I	I	TV

\* Fahrenheit to Celsius conversion key: 100°F (38°C), 125°F (52°C), 150°F (66°C), 275°F (135°C) and 500°F (260°C).

This chemical chart is offered as a guide only. There are many variables to be considered with each application. Ratings are for tube polymer only! For explanation of ratings see the initial page of these Chemical Charts in Appendix B. Contact Customer Service for chemicals or polymers not listed at 800-235-4632.

# Chemical Charts

### Rating Scale

A = May be used for Continuous Service  
 B = May be used for Intermittent Service  
 I = Insufficient data, contact Customer Service  
 X = Do not use

### Gasket

T = Teflon®  
 S = Silicone  
 N = Neoprene  
 B = Nitrile  
 V = Viton®

Continental ContiTech Chemical Hose / Hose Tube Polymer													Insta-Lock™ Fitting/Metal			
Temp. (°F)*	Fabchem UHMWPE	Gray Flexwing Butyl	Yellow Flexwing Hypalon	Tan Flexwing NR	Orange Flexwing Viton	Flexwing Petroleum Nitrile	Brown Flexwing & ExtremeFlex Brown CPE	Purple Flexwing & ExtremeFlex Purple EPDM	Blue Flexwing & Green XLPE XLPE	Chem One & Viper Alphasyn	HIPER Teflon	316 SS	Aluminum	Brass	Gasket	
<b>D</b>																
Diethyl Carbinol	100	A	A	A	A	B	A	I	I	A	A	A	I	I	I	TBN
Diethyl Ketone	100	A	B	X	X	X	X	X	X	A	B	A	I	I	I	T
Diethyl Oxalate	100	A	B	X	B	I	X	A	X	A	B	A	I	I	I	T
Diethyl Phthalate	100	A	A	X	X	X	X	B	X	A	B	A	I	I	I	T
Diethyl Sebacate	100	A	A	X	X	X	X	B	X	A	B	A	A	A	I	T
Diethyl Sulfate	100	A	B	X	X	X	X	A	I	A	A	A	X	I	I	TNS
Diethyl Triamine	100	A	A	X	B	I	B	A	I	A	A	A	I	I	I	T B
Diethylamine	100	A	A	X	B	I	B	B	B	A	B	A	A	I	X	T B
Diethylene Dioxide	100	A	B	X	X	X	X	B	A	A	A	A	X	X	X	T
Diethylene Glycol	100	A	A	A	A	A	A	X	A	A	A	A	A	B	A	TVBN
Diethylene Triamine	100	A	A	X	B	I	B	A	I	A	A	A	I	I	X	T
Dihydroxydiethyl Ether	100	A	A	A	A	A	A	A	A	A	A	A	I	I	I	TVBN
Dihydroxyethyl Amine	100	A	A	X	B	I	B	A	I	A	A	A	I	I	I	T B
Diisobutyl Ketone	100	A	B	X	X	X	X	I	B	A	B	A	I	I	I	T
Diisobutylene	100	A	X	X	X	A	A	X	X	A	B	A	A	I	I	TVB
Diisooctyl Adipate	100	A	A	X	X	X	X	I	I	A	I	A	I	I	I	T
Diisooctyl Phthalate	100	A	A	X	X	X	X	I	I	A	I	A	I	I	I	T
Diisocyanate	100	X	X	X	X	X	X	X	X	X	B	A	I	I	I	T
Diisodecyl Adipate	100	A	A	X	X	X	X	I	I	A	I	A	I	I	I	T
Diisodecyl Phthalate	100	A	A	X	X	X	X	I	I	A	I	A	I	I	I	T
Diisopropanol Amine	100	A	A	X	B	I	B	I	I	A	B	A	I	I	I	T B
Diisopropyl Amine	100	A	A	X	B	I	B	I	I	A	B	A	I	I	I	T B
Diisopropyl Ether	100	A	X	B	X	I	B	I	X	A	B	A	A	I	I	T B
Diisopropyl Ketone	100	A	B	X	X	X	X	I	B	A	B	A	A	A	I	T
Dilauryl Ether	100	A	I	B	X	I	B	I	I	A	B	A	I	I	I	T B
Dimethyl Amine	---	<b>No Hose Recommended For This Application</b>														
Dimethyl Benzene	100	A	X	X	X	A	X	X	X	A	B	A	A	I	I	T V
Dimethyl Ether	100	A	X	B	X	I	B	I	X	B	B	A	I	I	I	T B
Dimethyl Ketone	100	A	A	X	B	X	X	A	A	B	A	A	A	A	I	T
Dimethyl Phenol	100	A	X	X	X	A	X	I	X	A	A	A	I	I	I	T V
Dimethyl Phthalate	100	A	A	X	X	X	X	A	B	A	A	A	A	I	I	T V
Dimethyl Sulfate	100	A	B	X	X	X	X	A	I	A	A	A	I	I	I	T
Dimethyl Sulfide	---	<b>No Hose Recommended For This Application</b>														
Dimethyl Carbinol	100	A	A	A	A	B	A	A	A	A	A	A	A	I	I	TBNS
Dinitrobenzene	100	A	X	X	X	A	X	I	I	A	B	A	I	I	I	T V
Diocetyl Adipate	100	A	A	X	X	X	X	X	B	A	I	A	I	I	I	T
Diocetyl Amine	100	A	A	X	B	I	B	I	I	A	B	A	I	I	I	T
Diocetyl Phthalate	100	A	B	X	X	A	X	X	X	A	A	A	A	I	I	T V

\* Fahrenheit to Celsius conversion key: 100°F (38°C), 125°F (52°C), 150°F (66°C), 275°F (135°C) and 500°F (260°C).

This chemical chart is offered as a guide only. There are many variables to be considered with each application. Ratings are for tube polymer only! For explanation of ratings see the initial page of these Chemical Charts in Appendix B. Contact Customer Service for chemicals or polymers not listed at 800-235-4632.

# Chemical Charts

### Rating Scale

**A** = May be used for Continuous Service

**B** = May be used for Intermittent Service

**I** = Insufficient data, contact Customer Service

**X** = Do not use

### Gasket

**T** = Teflon®

**N** = Neoprene

**V** = Viton®

**S** = Silicone

**B** = Nitrile

Continental ContiTech Chemical Hose / Hose Tube Polymer													Insta-Lock™ Fitting/Metal			
Temp. (°F)*	Fabchem UHMWPE	Gray Flexwing Butyl	Yellow Flexwing Hypalon	Tan Flexwing NR	Orange Flexwing Viton	Flexwing Petroleum Nitrile	Brown Flexwing & ExtremeFlex Brown CPE	Purple Flexwing & ExtremeFlex Purple EPDM	Blue Flexwing & Green XLPE XLPE	Chem One & Viper Alphasyn	HIPER Teflon	316 SS	Aluminum	Brass	Gasket	
<b>D</b>																
Diocetyl Sebacate	100	A	A	X	X	X	X	X	B	A	I	A	I	I	I	T V
Dioxane	100	A	B	X	X	X	X	B	X	A	A	A	A	I	I	T
Dioxolane	100	A	X	X	X	I	X	B	X	A	B	A	I	I	I	T
Diphenyl Phthalate	100	A	A	X	X	X	X	I	I	A	A	A	I	I	I	T
Dipropyl Ketone	100	A	B	X	X	X	X	X	I	A	A	A	I	I	I	T
Dipropylamine	100	A	A	X	B	I	B	B	I	A	A	A	I	I	I	T
Dipropylene Glycol	100	A	A	A	A	A	A	A	I	A	A	A	I	I	I	TVB
Disodium Phosphate	100	A	A	A	A	I	A	A	I	A	A	A	A	I	B	T B
Divinyl Benzene	100	A	X	X	X	A	X	X	X	A	B	A	I	I	I	T V
Dodecyl Benzene	100	A	X	X	X	A	X	I	X	A	B	A	I	I	I	T V
Dodecyl Toluene	100	A	X	X	X	A	X	I	X	A	B	A	I	I	I	T V
Dow-Per	100	A	X	X	X	A	X	I	X	A	B	A	I	I	I	T V
Dowtherm A	100	A	I	X	X	A	X	X	X	A	A	A	I	A	I	T V
Dowtherm E	100	A	X	X	X	A	X	X	X	A	A	I	I	X	I	V
Dowtherm SR-1	100	A	A	A	A	A	A	I	I	A	A	A	I	I	I	TVB
<b>E</b>																
Endolene	100	I	I	I	I	I	I	I	I	I	I	I	I	I	I	I
Epichlorohydrin	---	<b>No Hose Recommended For This Application</b>														
Ethanol	100	A	A	A	A	B	A	A	A	A	A	A	A	B	A	TBN
Ethanol Amine	100	A	A	B	B	I	B	A	B	A	B	A	A	B	I	T B
Ethyl Acetate	100	A	B	X	X	X	X	B	A	A	A	A	A	A	A	T
Ethyl Acetoacetate	100	A	B	X	X	X	X	A	B	A	A	A	B	I	I	T
Ethyl Acrylate	100	A	X	X	X	X	X	B	X	B	B	A	A	A	A	T
Ethyl Alcohol	100	A	A	A	A	A	A	A	A	A	A	A	A	B	A	TVBNS
Ethyl Aldehyde	---	<b>No Hose Recommended For This Application</b>														
Ethyl Aluminum Dichloride	100	X	X	X	X	B	X	I	X	B	I	A	I	I	I	T V
Ethyl Benzene	100	A	X	X	X	A	X	X	X	A	B	A	A	A	X	T V
Ethyl Butanol	100	A	A	A	A	B	A	A	A	A	A	A	I	I	I	T B
Ethyl Butyl Acetate	100	A	A	B	X	X	X	I	I	A	B	A	I	I	I	T
Ethyl Butyl Alcohol	100	A	A	A	A	B	A	A	A	A	A	A	I	I	I	T B
Ethyl Butyl Amine	100	A	A	X	B	I	B	I	I	I	I	A	I	I	I	T B
Ethyl Butyl Ketone	100	A	B	X	X	X	X	X	I	A	A	A	I	I	I	T
Ethyl Butyraldehyde	100	A	B	X	X	X	X	X	I	A	B	A	I	I	I	T
Ethyl Chloride	---	<b>No Hose Recommended For This Application</b>														
Ethyl Dichloride	100	B	X	X	X	B	X	X	X	B	B	A	I	I	I	T V
Ethyl Ether	---	<b>No Hose Recommended For This Application</b>														
Ethyl Formate	100	A	B	X	X	X	X	A	B	A	A	A	A	I	I	T V
Ethyl Hexanol	100	A	A	A	A	B	A	A	A	A	A	A	I	I	I	TBN

\* Fahrenheit to Celsius conversion key: 100°F (38°C), 125°F (52°C), 150°F (66°C) and 500°F (260°C).

This chemical chart is offered as a guide only. There are many variables to be considered with each application. Ratings are for tube polymer only! For explanation of ratings see the initial page of these Chemical Charts in Appendix B. Contact Customer Service for chemicals or polymers not listed at 800-235-4632.

# Chemical Charts

**Rating Scale**

**A** = May be used for Continuous Service      **B** = May be used for Intermittent Service  
**I** = Insufficient data, contact Customer Service      **X** = Do not use

**Gasket**

**T** = Teflon®      **N** = Neoprene      **V** = Viton®  
**S** = Silicone      **B** = Nitrile

	Continental ContiTech Chemical Hose / Hose Tube Polymer												Insta-Lock™ Fitting/Metal			
	Temp. (°F)*	Fabchem UHMWPE	Gray Flexwing Butyl	Yellow Flexwing Hypalon	Tan Flexwing NR	Orange Flexwing Viton	Flexwing Petroleum Nitrile	Brown Flexwing & ExtremeFlex Brown CPE	Purple Flexwing & ExtremeFlex Purple EPDM	Blue Flexwing & Green XLPE XLPE	Chem One & Viper Alphasyn	HIPER Teflon	316 SS	Aluminum	Brass	Gasket
<b>E</b>																
Ethyl Hexoic Acid	100	A	X	B	X	I	X	I	I	A	A	A	I	I	I	T
Ethyl Hexyl Acetate	100	A	A	B	X	X	X	I	I	A	B	A	I	I	I	T
Ethyl Hexyl Alcohol	100	A	A	A	A	B	A	A	A	A	A	A	I	I	I	TBN
Ethyl Iodide	100	X	X	X	X	B	X	X	X	B	B	A	I	I	I	T V
Ethyl Isobutyl Ether	100	A	X	B	X	I	B	I	X	A	B	A	I	I	I	T
Ethyl Methyl Ketone	100	A	B	X	X	X	X	I	I	A	A	A	A	A	A	T
Ethyl Oxalate	100	A	A	X	A	I	X	A	X	A	B	A	I	I	I	T V
Ethyl Phthalate	100	A	A	X	X	X	X	B	I	A	I	A	I	I	I	T
Ethyl Propyl Ether	100	A	X	B	X	I	B	A	X	A	B	A	I	I	I	T B
Ethyl Propyl Ketone	100	A	B	X	X	X	X	I	I	A	A	A	I	I	I	T
Ethyl Silicate	100	A	A	I	X	I	A	A	I	A	A	A	A	I	I	TBN
Ethyl Sulfate	100	A	B	X	X	X	X	A	I	A	A	A	X	I	I	TBS
Ethylamine	---	<b>No Hose Recommended For This Application</b>														
Ethylene Bromide	100	X	X	X	X	B	X	I	X	B	B	A	A	X	I	T V
Ethylene Chloride	100	B	X	X	X	B	X	I	X	B	B	A	A	B	I	T V
Ethylene Diamine	100	A	A	X	B	I	B	I	B	A	I	A	A	I	I	T B
Ethylene Dibromide	100	X	X	X	X	B	X	I	X	B	B	A	A	X	I	T V
Ethylene Dichloride	100	B	X	X	X	B	X	X	X	B	A	A	A	B	I	T V
Ethylene Glycol	150	A	A	A	A	A	A	A	A	A	A	A	A	A	I	TVBNS
Ethylhexil Phosphorodieth	100	I	X	X	I	I	A	A	X	X	I	I	I	I	I	B
Ex-Tri	100	A	X	X	X	A	X	I	I	A	B	A	I	I	I	T V
<b>F</b>																
Ferric Bromide	150	A	A	A	A	A	A	A	A	A	A	A	I	I	I	TVB
Ferric Chloride	150	A	A	A	A	A	A	A	A	A	A	A	X	X	X	TVBNS
Ferric Sulfate	150	A	A	A	A	A	A	A	A	A	A	A	A	X	X	TVBN
Ferrous Acetate	100	A	A	A	X	X	X	I	I	A	A	A	I	I	I	T
Ferrous Chloride	150	A	A	A	A	B	A	A	A	A	A	A	I	X	X	T B
Ferrous Hydroxide	100	A	A	B	A	X	B	I	I	A	A	A	B	I	I	T N
Ferrous Sulfate	150	A	A	A	A	A	A	A	A	A	A	A	B	X	X	TVBN
Fluoboric Acid 65%	150	B	A	A	A	I	I	A	I	I	A	A	I	I	X	T N
Fluorine (wet)	100	X	X	X	X	X	X	X	X	X	X	B	X	X	X	T
Fluosilicic Acid 50%	150	B	A	A	A	I	I	A	I	I	A	A	A	X	X	T N
Formaldehyde 40%	100	A	A	A	B	B	A	A	A	A	A	A	A	B	I	T B
Formalin	100	A	A	A	B	A	A	A	A	A	A	A	A	B	I	TVB
Formic Acid	100	A	A	X	B	X	X	A	A	B	A	A	B	I	X	T V
Freon 12	100	A	X	X	X	B	B	I	X	B	X	A	A	I	I	T N
Freon 22	100	A	X	X	X	X	X	I	I	B	X	A	A	I	I	T N
Fuel A (ASTM)	100	B	X	X	X	A	A	I	X	B	B	A	A	A	A	TVB

\* Fahrenheit to Celsius conversion key: 100°F (38°C), 125°F (52°C), 150°F (66°C), 275°F (135°C) and 500°F (260°C).

This chemical chart is offered as a guide only. There are many variables to be considered with each application. Ratings are for tube polymer only! For explanation of ratings see the initial page of these Chemical Charts in Appendix B. Contact Customer Service for chemicals or polymers not listed at 800-235-4632.

# Chemical Charts

### Rating Scale

**A** = May be used for Continuous Service

**B** = May be used for Intermittent Service

**I** = Insufficient data, contact Customer Service

**X** = Do not use

### Gasket

**T** = Teflon®

**N** = Neoprene

**V** = Viton®

**S** = Silicone

**B** = Nitrile

	Temp. (°F)*	Continental ContiTech Chemical Hose / Hose Tube Polymer											Insta-Lock™ Fitting/Metal			
		Fabchem UHMWPE	Gray Flexwing Butyl	Yellow Flexwing Hypalon	Tan Flexwing NR	Orange Flexwing Viton	Flexwing Petroleum Nitrile	Brown Flexwing & ExtremeFlex Brown CPE	Purple Flexwing & ExtremeFlex Purple EPDM	Blue Flexwing & Green XLPE XLPE	Chem One & Viper Alphasyn	HIPER Teflon	316 SS	Aluminum	Brass	Gasket
<b>F</b>																
Fuel B (ASTM)	100	B	X	X	X	A	A	I	X	B	B	A	I	I	I	TVB
Fuel Oil	100	A	X	X	X	A	A	X	X	B	B	A	A	A	I	TVB
Furfural	100	A	A	I	I	X	X	A	B	A	A	A	A	A	X	T
Furfuryl Alcohol	100	A	X	I	I	X	I	A	I	A	A	A	A	A	I	T
<b>G</b>																
Gallic Acid	100	A	B	I	A	I	I	A	B	I	B	A	B	I	I	T S
Gasoline	100	B	X	X	X	A	A	B	X	B	B	A	A	I	I	TVB
Glacial Acetic Acid	100	A	B	X	X	X	X	B	A	A	A	A	A	B	X	T
Gluconic Acid	100	A	X	B	X	I	X	A	I	A	A	A	X	X	A	T
Glycerin	100	A	A	A	A	A	A	A	A	B	A	A	A	A	A	TVBNS
Glyphosate	100	A	I	I	I	I	I	I	A	I	I	I	I	I	I	I
Graffinite	100	I	X	X	X	X	A	A	X	X	I	I	I	I	I	B
Grease	100	A	X	X	X	A	A	I	X	B	A	A	A	A	A	TVB
Green Sulfate Liquor	150	A	A	A	A	I	A	A	A	A	A	A	A	X	X	TBS
<b>H</b>																
Heptanal	100	A	X	X	X	X	X	X	I	A	I	A	I	I	I	T B
Heptane	100	A	X	X	X	A	A	A	X	B	B	A	A	A	I	TVB
Heptane Carboxylic Acid	100	A	X	B	X	A	X	A	I	A	A	A	I	I	I	T V
Hexaldehyde	100	A	X	X	X	X	X	I	X	A	B	A	A	A	I	T
Hexane	100	B	X	X	X	A	A	B	X	B	B	A	A	A	A	TVB
Hexanol	100	A	A	A	A	B	A	A	A	A	A	A	A	I	I	T B
Hexyl Methyl Ketone	100	A	B	X	X	X	X	I	I	A	A	A	I	I	I	T
Hexylamine	100	A	B	X	X	X	X	B	I	A	B	A	I	I	I	T
Hexylene	100	X	X	X	X	A	A	I	X	X	I	A	I	I	I	TVB
Hexylene Glycol	150	A	A	A	A	A	A	A	I	A	A	A	A	B	A	TVBN
Hexyl-Alcohol	100	A	A	A	A	B	A	A	X	A	A	A	A	I	I	T B
Hi-Tri	100	A	X	X	X	A	X	I	X	A	B	A	I	I	I	T V
Hydrobromic Acid (37%)	150	B	A	A	A	I	X	A	A	I	A	A	X	X	X	T N
Hydrochloric Acid 38% concentrated, fuming acid	125	A	B	X	I	I	X	X	I	A	I	A	X	X	X	T
Hydrochloric Acid 37%	125	A	B	A	B	X	X	A	B	A	A	A	X	X	X	T
Hydrofluoric Acid (10%)	125	A	A	A	X	I	X	A	I	A	A	A	A	X	X	T N
Hydrofluosilicic Acid	150	B	B	A	A	I	I	A	A	I	A	A	A	X	X	T
Hydrogen Dioxide 10%	100	B	X	X	X	A	X	I	I	I	I	A	A	B	X	T V
Hydrogen Dioxide over 10%	100	B	X	X	X	I	X	I	X	I	I	A	I	I	X	T
Hydrogen Gas	---	<b>No Hose Recommended For This Application</b>														
Hydrogen Peroxide 10% to 50%	100	B	X	X	X	A	X	A	I	I	I	A	I	B	I	TVS

\* Fahrenheit to Celsius conversion key: 100°F (38°C), 125°F (52°C), 150°F (66°C), 275°F (135°C) and 500°F (260°C).

This chemical chart is offered as a guide only. There are many variables to be considered with each application. Ratings are for tube polymer only! For explanation of ratings see the initial page of these Chemical Charts in Appendix B. Contact Customer Service for chemicals or polymers not listed at 800-235-4632.



# Chemical Charts

### Rating Scale

A = May be used for Continuous Service      B = May be used for Intermittent Service  
 I = Insufficient data, contact Customer Services      X = Do not use

### Gasket

T = Teflon®      N = Neoprene      V = Viton®  
 S = Silicone      B = Nitrile

Continental ContiTech Chemical Hose / Hose Tube Polymer													Insta-Lock™ Fitting/Metal			
Temp. (°F)*	Fabchem UHMWPE	Gray Flexwing Butyl	Yellow Flexwing Hypalon	Tan Flexwing NR	Orange Flexwing Viton	Flexwing Petroleum Nitrile	Brown Flexwing & ExtremeFlex Brown CPE	Purple Flexwing & ExtremeFlex Purple EPDM	Blue Flexwing & Green XLPE	Chem One & Viper Alphasyn	HIPER Teflon	316 SS	Aluminum	Brass	Gasket	
<b>H</b>																
Hydrogen Peroxide over 50%	100	X	X	X	X	X	X	X	X	X	I	A	A	I	X	T
<b>I</b>																
Iodine	100	A	I	A	I	I	A	I	B	I	A	I	I	X	TVB	
Iron Acetate	100	A	A	A	X	X	X	I	I	A	A	A	I	I	I	TNS
Iron Hydroxide	100	A	A	B	X	X	B	I	I	A	A	A	I	I	I	T N
Iron Salts	150	A	A	A	A	A	A	A	A	A	A	A	I	I	I	TVBN
Iron Sulfate	150	A	A	A	A	A	A	A	A	A	A	A	I	I	I	TVBN
Iron Sulfide	150	A	A	A	A	A	A	A	A	A	A	A	I	I	I	TVB
Isoamyl Acetate	100	A	A	B	X	X	X	I	X	A	B	A	I	I	I	T
Isoamyl Alcohol	100	A	A	A	A	B	A	A	A	A	A	A	A	I	A	TBN
Isoamyl Bromide	100	B	X	X	X	B	X	I	X	B	I	A	I	I	I	T V
Isoamyl Butyrate	100	B	X	X	X	X	X	I	I	B	B	A	I	I	I	T
Isoamyl Chloride	100	X	X	X	X	B	X	I	I	X	B	A	I	I	I	T V
Isoamyl Ether	100	A	X	B	X	I	B	I	X	A	I	A	I	I	I	T
Isoamyl Phthalate	100	A	A	X	X	X	X	I	I	A	I	A	I	I	I	T
Isobutane	---	<b>No Hose Recommended For This Application</b>														
Isobutanol	100	A	A	A	A	B	A	A	A	A	A	A	A	I	I	TBNS
Isobutyl Acetate	100	A	A	B	X	X	X	B	X	A	B	A	A	B	I	T
Isobutyl Alcohol	100	A	A	A	A	B	X	A	A	A	A	A	A	I	I	TNS
Isobutyl Aldehyde	100	A	B	X	X	X	X	B	I	A	B	A	I	I	I	T
Isobutyl Amine	100	A	B	X	X	X	X	I	I	A	B	A	I	I	I	T
Isobutyl Bromide	100	B	X	X	X	B	X	I	X	X	I	A	I	I	I	T V
Isobutyl Carbinol	100	A	A	A	A	B	A	A	A	A	A	A	A	I	A	TBN
Isobutyl Chloride	100	B	X	X	X	B	X	I	X	X	I	A	I	I	I	T V
Isobutyl Ether	100	A	X	B	X	I	X	I	X	A	I	A	I	I	I	T B
Isobutylene	100	A	X	X	X	A	X	I	X	A	B	A	I	I	I	T V
Isocotane	100	B	X	X	X	A	A	I	X	B	B	A	A	A	A	TVBS
Isopentane	---	<b>No Hose Recommended For This Application</b>														
Isophorone	100	B	A	I	I	I	X	I	A	B	B	A	B	A	I	T
Isopropanol	100	A	A	A	A	B	A	A	A	A	A	A	A	I	I	TVBS
Isopropanol Amine	100	A	A	X	B	X	B	I	I	A	B	A	I	I	I	T B
Isopropyl Acetate	100	A	A	X	X	X	X	B	X	A	A	A	A	I	I	T
Isopropyl Alcohol	100	A	A	A	A	B	A	A	A	A	A	A	A	I	I	TBNS
Isopropyl Amine	100	A	B	X	X	X	X	I	I	A	B	A	I	I	I	T
Isopropyl Benzene	100	A	X	X	X	A	X	X	X	A	B	A	I	I	I	T V
Isopropyl Chloride	---	<b>No Hose Recommended For This Application</b>														
Isopropyl Ether	100	A	X	B	X	I	X	I	X	A	B	A	A	I	I	T B
Isopropyl Toluene	100	A	X	X	X	A	X	I	X	A	I	A	I	I	I	T V

\* Fahrenheit to Celsius conversion key: 100°F (38°C), 125°F (52°C), 150°F (66°C), 275°F (135°C) and 500°F (260°C).

This chemical chart is offered as a guide only. There are many variables to be considered with each application. Ratings are for tube polymer only! For explanation of ratings see the initial page of these Chemical Charts in Appendix B. Contact Customer Service for chemicals or polymers not listed at 800-235-4632.

# Chemical Charts

### Rating Scale

**A** = May be used for Continuous Service  
**I** = Insufficient data, contact Customer Service  
**B** = May be used for Intermittent Service  
**X** = Do not use

### Gasket

**T** = Teflon®  
**S** = Silicone  
**N** = Neoprene  
**B** = Nitrile  
**V** = Viton®

Continental ContiTech Chemical Hose / Hose Tube Polymer													Insta-Lock™ Fitting/Metal			
Temp. (°F)*	Fabchem UHMWPE	Gray Flexwing Butyl	Yellow Flexwing Hypalon	Tan Flexwing NR	Orange Flexwing Viton	Flexwing Petroleum Nitrile	Brown Flexwing & ExtremeFlex Brown CPE	Purple Flexwing & ExtremeFlex Purple EPDM	Blue Flexwing & Green XLPE XLPE	Chem One & Viper Alphasyn	HIPER Teflon	316 SS	Aluminum	Brass	Gasket	
<b>J</b>																
Jet Fuels	---	Special Hose Required										A	A	A	TVB	
<b>K</b>																
Kerosene	100	A	X	X	X	A	A	A	X	A	A	A	A	A	I	TVB
<b>L</b>																
Lauryl Alcohol	100	A	A	A	A	B	A	A	A	A	A	A	I	I	I	T B
Lead Acetate	100	A	A	X	X	X	X	A	B	A	A	A	A	X	X	T
Lead Sulfate	150	A	A	A	A	A	A	A	A	A	A	A	A	X	X	TVBN
Ligroin	100	A	X	X	X	A	A	I	X	A	B	A	A	A	I	T V B
Linseed Oil	100	A	A	B	X	A	A	A	B	I	A	A	A	I	A	vTVBNS
Liquefied Natural Gas (LNG)	---	No Hose Recommended For This Application														
Liquefied Petroleum Gas (LPG)	---	No Hose Recommended For This Application														
Lubricating Oils	100	A	X	X	X	A	A	I	X	A	I	A	A	A	A	T V B
<b>M</b>																
MIBK	100	A	X	X	X	X	X	X	X	A	B	A	X	X	X	T
M.E.K.	100	A	X	X	X	X	X	X	X	A	B	A	X	X	X	T
Magnesium Acetate	100	A	A	A	X	X	X	A	I	A	A	A	I	I	I	T
Magnesium Chloride	150	A	A	A	A	A	A	A	A	A	A	A	A	X	I	TVBS
Magnesium Hydrate	150	A	A	B	A	B	B	I	I	A	A	A	A	X	I	T N
Magnesium Hydroxide	150	A	A	B	A	B	B	A	A	A	A	A	A	X	I	TVBN
Magnesium Sulfate	150	A	A	A	A	A	A	A	B	A	A	A	A	I	I	TVBNS
Maleic Acid	100	A	X	X	X	I	X	I	I	B	I	A	A	B	X	T V
Malic Acid	150	B	I	A	A	I	I	I	I	I	I	A	A	B	X	TVBNS
Manganese Sulfate	150	A	A	A	X	A	A	A	A	A	A	A	A	I	I	TVBN
Manganese Sulfide	150	A	A	A	X	A	A	A	A	A	A	A	I	I	I	TVB
Manganese Sulfite	150	A	A	A	X	A	A	A	A	A	A	A	I	I	I	TVB
Methanol	100	A	A	A	A	X	A	A	A	A	A	A	A	I	I	T B
Mesityl Oxide	100	A	B	X	X	X	X	B	X	A	B	A	A	I	I	T
Methallyl Alcohol	100	A	A	A	A	B	A	A	A	A	A	A	I	I	I	T B
Methyl (Wood) Alcohol	100	A	A	A	A	X	A	A	A	A	A	A	A	I	I	TBNS
Methyl Acetate	100	A	A	B	X	X	X	A	A	A	A	A	A	I	I	T
Methyl Acetoacetate	100	A	B	X	X	X	X	A	I	A	A	A	I	I	I	T
Methyl Acetone	---	No Hose Recommended For This Application														
Methyl Amyl Acetate	100	B	A	B	X	X	X	I	X	A	B	A	I	I	I	T
Methyl Amyl Alcohol	100	A	A	A	A	B	A	A	A	A	A	A	I	I	I	TBN
Methyl Amyl Carbinol	100	A	A	A	A	B	A	A	A	A	A	A	I	I	I	T B
Methyl Amyl Ketone	100	A	B	X	X	X	X	X	I	A	B	A	I	I	I	T
Methyl Benzene	100	A	X	X	X	A	X	X	X	A	B	A	A	A	A	T V
Methyl Butanol	100	A	A	A	A	B	A	A	I	A	A	A	A	I	A	TBN

\* Fahrenheit to Celsius conversion key: 100°F (38°C), 125°F (52°C), 150°F (66°C), 275°F (135°C) and 500°F (260°C).

This chemical chart is offered as a guide only. There are many variables to be considered with each application. Ratings are for tube polymer only! For explanation of ratings see the initial page of these Chemical Charts in Appendix B. Contact Customer Service for chemicals or polymers not listed at 800-235-4632.

# Chemical Charts

**Rating Scale**

A = May be used for Continuous Service      B = May be used for Intermittent Service  
 I = Insufficient data, contact Customer Service      X = Do not use

**Gasket**

T = Teflon®      N = Neoprene      V = Viton®  
 S = Silicone      B = Nitrile

Continental ContiTech Chemical Hose / Hose Tube Polymer														Insta-Lock™ Fitting/Metal			
Temp. (°F)*	Fabchem UHMWPE	Gray Flexwing Butyl	Yellow Flexwing Hypalon	Tan Flexwing NR	Orange Flexwing Viton	Flexwing Petroleum Nitrile	Brown Flexwing & ExtremeFlex Brown CPE	Purple Flexwing & ExtremeFlex Purple EPDM	Blue Flexwing & Green XLPE XLPE	Chem One & Viper Alphasyn	HIPER Teflon	316 SS	Aluminum	Brass	Gasket		
<b>M</b>																	
Methyl Butanone	100	A	B	X	X	X	X	B	B	A	B	A	I	I	I	T	
Methyl Butyl Ketone	100	A	B	X	X	X	X	X	I	A	B	A	A	B	I	T	
Methyl Carbitol	100	A	A	A	X	I	X	A	I	A	A	A	I	I	I	T	
Methyl Cellosolve	100	A	A	A	X	I	X	A	A	A	A	A	A	B	A	T	
Methyl Chloride	---	<b>No Hose Recommended For This Application</b>															
Methyl Cyclohexane	100	A	X	X	X	B	X	B	X	B	I	A	I	I	I	TV	
Methyl Ethyl Ketone (M.E.K.)	100	A	X	X	X	X	X	X	X	A	B	A	X	X	X	T	
Methyl Hexanol	100	A	A	A	B	A	A	A	A	A	A	A	I	I	I	TVB	
Methyl Hexanone	100	A	B	X	X	X	X	X	I	A	B	A	I	I	I	T	
Methyl Hexyl Ketone	100	A	B	X	X	X	X	X	I	A	B	A	I	I	I	T	
Methyl Isobutyl Carbinol	100	A	A	A	A	B	A	A	A	A	A	A	B	I	I	TBN	
Methyl Isobutyl Ketone (MIBK)	100	A	X	X	X	X	X	X	X	A	B	A	X	X	X	T	
Methyl Isopropyl Ketone	100	A	B	X	X	X	X	B	B	A	B	A	A	I	I	T	
Methyl Normal Amyl Ketone	100	A	B	X	X	X	X	I	I	A	B	A	I	I	I	T	
Methyl Propyl Carbinol	100	A	A	A	A	B	A	A	A	A	A	A	I	I	I	TB	
Methyl Propyl Ether	100	A	X	B	X	I	X	I	X	A	B	A	I	I	I	T	
Methyl Propyl Ketone	100	A	B	X	X	X	X	B	I	A	B	A	I	I	I	T	
Methyl Tertiary Butyl Ether (MTBE)	100	X	X	X	X	X	X	X	X	A	B	I	I	I	I	I	
Methylalyl Acetate	100	A	A	B	X	X	X	I	A	A	A	A	I	I	I	T	
Methylalyl Chloride	100	A	X	X	X	X	X	X	I	B	I	A	I	I	I	T	
Methyldiethanolamine	100	A	X	X	X	X	A	A	X	A	A	A	I	I	I	TB	
Methylene Bromide	100	B	X	X	X	B	X	I	X	B	A	A	I	I	I	TV	
Methylene Chloride	---	<b>No Hose Recommended For This Application</b>															
Metribuzin	100	A	I	I	I	I	I	I	A	I	I	A	I	I	I	T	
Mineral Spirits	100	A	X	X	X	B	A	I	X	A	B	A	A	A	I	TB	
Monochloroacetic Acid	100	A	X	X	B	I	X	A	X	A	A	A	A	X	X	T	
Monochlorobenzene	100	B	X	X	X	A	X	X	X	B	B	A	A	B	B	TV	
Monochlorodifluoromethane	100	I	X	X	X	X	X	I	I	I	I	A	A	I	I	TN	
Monoethanol Amine	100	A	A	X	B	I	B	A	B	A	B	A	A	B	I	TN	
Monoethyl Amine	---	<b>No Hose Recommended For This Application</b>															
Monoisopropanol Amine	100	A	A	X	B	I	B	I	I	A	B	A	I	I	I	TBw	

\* Fahrenheit to Celsius conversion key: 100°F (38°C), 125°F (52°C), 150°F (66°C), 275°F (135°C) and 500°F (260°C).

This chemical chart is offered as a guide only. There are many variables to be considered with each application. Ratings are for tube polymer only! For explanation of ratings see the initial page of these Chemical Charts in Appendix B. Contact Customer Service for chemicals or polymers not listed at 800-235-4632.

# Chemical Charts

### Rating Scale

A = May be used for Continuous Service  
 B = May be used for Intermittent Service  
 I = Insufficient data, contact Customer Service  
 X = Do not use

### Gasket

T = Teflon®  
 S = Silicone  
 N = Neoprene  
 B = Nitrile  
 V = Viton®

Continental ContiTech Chemical Hose / Hose Tube Polymer													Insta-Lock™ Fitting/Metal			
Temp. (°F)*	Fabchem UHMWPE	Gray Flexwing Butyl	Yellow Flexwing Hypalon	Tan Flexwing NR	Orange Flexwing Viton	Flexwing Petroleum Nitrile	Brown Flexwing & ExtremeFlex Brown CPE	Purple Flexwing & ExtremeFlex Purple EPDM	Blue Flexwing & Green XLPE XLPE	Chem One & Viper Alphasyn	HIPER Teflon	316 SS	Aluminum	Brass	Gasket	
<b>M</b>																
Methylpyrrolidone	100	A	X	X	X	X	X	X	A	I	A	I	I	I	T	
Muriatic Acid	125	A	X	X	A	I	X	A	X	A	A	X	X	X	T	
<b>N</b>																
Naphtha	100	A	X	X	X	A	A	A	X	A	A	A	A	I	TVBN	
Naphthalene	100	A	X	X	X	A	X	I	X	A	I	A	A	B	I	TV
Natural Gas	---	No Hose Recommended For This Application														
Neohexane	100	A	X	X	X	A	A	B	X	A	B	A	A	A	I	TVB
Neu-Tri	100	A	X	X	X	A	X	I	X	A	B	A	I	I	I	TV
Nickel Chloride	150	A	A	A	A	A	A	A	A	A	A	A	B	X	X	TVBS
Nickel Nitrate	150	A	A	A	A	A	A	A	A	A	A	A	B	X	X	TVBN
Nickel Sulfate	150	A	A	A	A	A	A	A	A	A	A	A	A	X	X	TVBNS
Nitric Acid 25%	100	B	B	X	X	X	X	X	X	B	A	A	A	X	X	TV
Nitric Acid 37%	100	X	X	X	X	X	X	X	X	X	A	A	A	X	X	TV
Nitric Acid 40%-60%	100	X	X	X	X	X	X	X	X	B	A	A	A	X	X	TV
Nitric Acid 70%	100	X	X	X	X	X	X	X	X	B	A	B	X	X	T	
Nitro Benzene	100	A	X	X	X	B	X	X	X	A	B	A	A	B	X	T
Nitrogen Gas	100	A	A	A	A	A	A	A	A	A	A	A	A	I	I	TVBNS
Nitrous Oxide	100	A	A	A	A	A	A	A	A	A	A	A	A	I	X	TVBNS
Nonenes	100	A	X	X	X	A	A	I	X	A	B	A	I	I	I	V B
<b>O</b>																
Octadecanoic Acid	100	A	B	X	X	I	A	A	B	A	A	A	A	B	A	T B
Octane	100	B	X	X	X	A	A	A	X	B	B	A	B	I	B	TVB
Octanol	100	A	A	A	A	B	A	A	X	A	A	A	A	I	I	TBN
Octyl Acetate	100	A	A	A	X	X	X	X	I	A	B	A	I	I	I	T
Octyl Alcohol	100	A	A	A	A	B	A	A	X	A	A	A	A	I	I	T B
Octyl Aldehyde	100	A	X	X	X	X	X	I	I	A	I	A	I	I	I	T
Octyl Amine	100	A	B	X	X	X	X	B	I	A	B	A	I	I	I	T
Octyl Carbinol	100	A	A	A	A	B	A	A	A	A	A	A	I	I	I	T B
Octylene Glycol	100	A	A	A	A	A	A	A	A	A	A	A	I	I	I	TVB
Oil Petroleum	100	B	X	X	X	A	A	A	X	A	B	A	A	A	X	TVB
Oleic Acid	100	A	B	X	X	I	B	A	X	A	B	A	A	B	X	T B
Oleum	100	X	X	X	X	X	X	X	X	X	X	A	I	X	X	TV
Organic Fatty Acids	100	A	X	X	X	X	A	A	X	A	B	A	A	I	I	T B
Orthodichlorobenzene	100	A	X	X	X	A	X	I	X	A	B	A	I	I	I	TV
Orthodichlorobenzol	100	A	X	X	X	A	X	I	X	A	I	A	I	I	I	TV
Orthoxylylene	100	B	X	X	X	A	X	I	X	A	B	A	I	I	I	TV
Oxalic Acid	100	A	A	X	X	I	X	A	B	I	B	A	A	B	X	T S
Oxygen	---	No Hose Recommended For This Application														
Ozone	100	A	B	B	X	I	X	A	A	I	B	A	I	I	I	T S

\* Fahrenheit to Celsius conversion key: 100°F (38°C), 125°F (52°C), 150°F (66°C), 275°F (135°C) and 500°F (260°C).

This chemical chart is offered as a guide only. There are many variables to be considered with each application. Ratings are for tube polymer only! For explanation of ratings see the initial page of these Chemical Charts in Appendix B. Contact Customer Service for chemicals or polymers not listed at 800-235-4632.

# Chemical Charts

**Rating Scale**

**A** = May be used for Continuous Service      **B** = May be used for Intermittent Service  
**I** = Insufficient data, contact Customer Service      **X** = Do not use

**Gasket**

**T** = Teflon®      **N** = Neoprene      **V** = Viton®  
**S** = Silicone      **B** = Nitrile

	Temp. (°F)*	Continental ContiTech Chemical Hose / Hose Tube Polymer											Insta-Lock™ Fitting/Metal			
		Fabchem UHMWPE	Gray Flexwing Butyl	Yellow Flexwing Hypalon	Tan Flexwing NR	Orange Flexwing Viton	Flexwing Petroleum Nitrile	Brown Flexwing & ExtremeFlex Brown CPE	Purple Flexwing & ExtremeFlex Purple EPDM	Blue Flexwing & Green XLPE XLPE	Chem One & Viper Alphasyn	HIPER Teflon	316 SS	Aluminum	Brass	Gasket
<b>P</b>																
Palmitic Acid	100	A	A	B	X	I	A	A	B	B	B	A	A	I	X	TBS
Papermakers Alum	150	A	A	A	A	A	A	A	A	A	A	A	I	I	I	TVBN
Paradichlorobenzol	100	B	X	X	X	A	X	I	X	A	I	A	I	I	I	TV
Paraffin	150	A	B	X	X	A	A	A	X	X	I	A	A	A	A	TVB
Paraldehyde	100	A	B	X	X	X	X	I	B	A	B	A	A	A	I	T
Paraxylene	100	A	X	X	X	A	X	I	X	A	B	A	I	I	I	TV
Pelargonic Acid	100	A	A	X	X	I	A	I	I	A	I	A	I	I	I	TB
Pentachloroethane	100	A	X	X	X	A	X	I	X	A	I	A	A	B	X	TV
Pentane	---	<b>No Hose Recommended For This Application</b>														
Pentanol	100	A	A	A	A	B	A	A	A	A	A	A	I	I	I	TBN
Pentanone	100	A	B	X	X	X	X	B	I	A	B	A	I	I	I	T
Perchloroethylene	100	B	X	X	X	A	X	X	X	A	B	A	A	B	X	TV
Petroleum Ether (Ligroin)	100	A	X	X	X	A	A	A	X	A	B	A	A	A	I	TVB
Petroleum - Crude	100	A	X	X	X	A	A	A	X	A	B	A	A	A	X	TVB
Petroleum Oils	100	A	X	X	X	A	A	A	X	A	B	A	A	A	X	TVB
Phenol	125	A	A	X	X	A	X	A	X	A	B	A	A	B	B	TV
Phenolsulfonic Acid	100	X	X	X	X	X	X	A	I	B	B	A	B	I	I	T
Phenyl Chloride	100	A	X	X	X	A	X	X	X	A	B	A	A	B	I	TV
Phosphoric Acid 10%	150	A	A	A	A	X	A	A	A	A	A	A	A	X	X	TVBN
Phosphoric Acid 10-85%	100	A	A	A	B	X	X	A	A	A	A	A	A	X	I	TVN
Pine Oil	100	A	X	X	X	A	X	B	X	A	B	A	A	I	X	TV
Pinene	100	A	X	X	X	A	B	B	X	A	B	A	B	I	I	TV
Polyethylene Glycol	150	A	A	A	A	A	A	A	A	A	A	A	I	I	I	TVBN
Polypropylene Glycol	150	A	A	A	A	A	A	A	A	A	A	A	I	I	I	TVB
Potassium Acetate	100	A	A	B	X	X	X	A	B	A	A	A	A	X	X	TB
Potassium Bisulfate	150	A	A	A	A	A	A	A	A	A	A	A	A	I	X	TVBN
Potassium Bisulfite	150	A	A	A	A	A	A	A	A	A	A	A	I	I	I	TVBN
Potassium Carbonate	150	A	A	A	A	A	A	A	A	A	A	A	A	X	X	TVBNS
Potassium Chloride	150	A	A	A	A	A	A	A	A	A	A	A	A	X	X	TVBNS
Potassium Chromate	150	B	A	X	I	I	I	A	I	B	B	A	B	I	I	TVBN
Potassium Dichromate	150	B	A	X	I	I	I	A	I	B	B	A	A	B	X	TVBNS
Potassium Hydrate	150	A	A	B	A	X	B	A	B	A	A	A	A	X	I	TS
Potassium Hydroxide	150	B	A	B	A	X	B	A	B	A	A	A	A	X	X	TN
Potassium Nitrate	150	A	A	A	A	A	A	A	A	A	A	A	A	B	A	TVBNS
Potassium Permanganate	100	A	A	A	A	A	B	I	I	A	A	A	A	I	I	TVS
Potassium Silicate	150	A	A	A	A	A	A	A	A	A	A	A	A	I	I	TVBNS
Potassium Sulfate	150	A	A	A	A	A	A	A	A	A	A	A	A	B	A	TVBNS
Potassium Sulfide	150	A	A	A	A	A	A	A	A	A	A	A	A	X	X	TVBNS

\* Fahrenheit to Celsius conversion key: 100°F (38°C), 125°F (52°C), 150°F (66°C), 275°F (135°C) and 500°F (260°C).

This chemical chart is offered as a guide only. There are many variables to be considered with each application. Ratings are for tube polymer only! For explanation of ratings see the initial page of these Chemical Charts in Appendix B. Contact Customer Service for chemicals or polymers not listed at 800-235-4632.

# Chemical Charts

**Rating Scale**

**A** = May be used for Continuous Service  
**I** = Insufficient data, contact Customer Service  
**B** = May be used for Intermittent Service  
**X** = Do not use

**Gasket**

**T** = Teflon®  
**S** = Silicone  
**N** = Neoprene  
**B** = Nitrile  
**V** = Viton®

Continental ContiTech Chemical Hose / Hose Tube Polymer													Insta-Lock™ Fitting/Metal			
Temp. (°F)*	Fabchem UHMWPE	Gray Flexwing Butyl	Yellow Flexwing Hypalon	Tan Flexwing NR	Orange Flexwing Viton	Flexwing Petroleum Nitrile	Brown Flexwing & ExtremeFlex Brown CPE	Purple Flexwing & ExtremeFlex Purple EPDM	Blue Flexwing & Green XLPE XLPE	Chem One & Viper Alphasyn	HIPER Teflon	316 SS	Aluminum	Brass	Gasket	
<b>P</b>																
Potassium Sulfite	150	A	A	A	A	A	A	A	A	A	A	A	I	X	TVBNS	
Propanediol	100	A	A	A	A	A	A	A	A	A	A	I	I	I	TVBS	
Propane Gas	---	X	X	X	X	X	X	X	X	X	X	X	X	X		
Propanol	100	A	A	A	A	B	A	A	A	A	A	A	I	I	TVB	
Propyl Acetate	100	A	A	B	X	X	X	B	X	A	B	A	A	I	T	
Propyl Alcohol	100	A	A	A	A	B	A	A	A	A	A	A	I	I	T B	
Propyl Aldehyde	100	A	B	X	X	X	X	X	I	A	B	A	I	I	T	
Propyl Chloride	---	<b>No Hose Recommended For This Application</b>														
Propylene Diamine	100	A	A	X	B	I	B	A	I	A	I	A	I	I	T B	
Propylene Dichloride	100	B	X	X	X	B	X	X	X	B	I	A	A	X	T V	
Propylene Glycol	100	A	A	A	A	A	A	A	A	A	A	A	I	I	TVBS	
Propylene Tetramer	100	A	X	X	X	X	A	A	X	A	B	I	I	I	B	
<b>S</b>																
Sea Water	100	A	A	A	A	A	A	A	A	A	A	A	A	I	X	TVBNS
Sewage	100	A	X	A	X	I	A	A	A	A	A	A	A	X	I	TBNS
Silicate of Soda	100	A	A	A	A	A	A	A	A	A	A	A	A	X	X	TVBNS
Soap	100	A	X	X	X	X	A	A	X	X	I	A	A	X	X	TBNS
Soda Ash	100	A	A	A	A	A	A	A	A	A	A	A	A	X	I	TVBNS
Soda, Caustic	100	A	A	B	A	X	B	A	A	A	A	A	A	X	X	TNS
Soda, Lime	100	A	A	B	A	X	B	A	A	A	A	A	I	I	I	TVB
Soda, Niter	100	A	A	A	A	A	A	A	B	A	A	A	A	B	I	TVB
Sodium Acetate	100	A	A	A	X	X	X	A	B	B	B	A	A	I	A	TNS
Sodium Aluminate	100	A	A	A	A	A	A	A	A	A	A	A	A	I	I	TVBN
Sodium Bisulfate	150	A	A	A	A	A	A	A	A	A	A	A	A	X	X	TVBNS
Sodium Bisulfite	150	A	A	A	A	A	A	A	A	A	A	A	A	X	X	TVBNS
Sodium Carbonate	150	A	A	A	A	A	A	A	A	A	A	A	A	X	I	TVBNS
Sodium Chloride (Brine)	150	A	A	A	A	A	A	A	A	A	A	A	A	X	I	TVBNS
Sodium Chromate	150	X	A	X	I	I	I	A	I	X	I	A	A	A	A	TVBN
Sodium Dichromate	150	A	A	X	I	I	I	A	A	A	A	A	A	I	X	T
Sodium Hydrate	150	A	A	B	A	X	B	A	A	A	A	A	B	X	X	T N
Sodium Hydrosulfide	100	A	X	X	X	X	A	A	X	A	I	A	I	B	I	T B
Sodium Hydroxide (50%)	150	A	A	B	A	X	B	A	A	A	A	A	A	X	X	TBN
Sodium Hypochlorite	100	B	B	X	X	B	X	A	A	X	B	A	X	X	X	TVS
Sodium Nitrate	150	A	A	A	A	A	A	A	B	A	A	A	A	B	I	TVBNS
Sodium Silicate	150	A	A	A	A	A	A	A	A	A	A	A	A	X	X	TVBNS
Sodium Sulfate	150	A	A	A	A	A	A	A	A	A	A	A	A	B	X	TVBNS
Sodium Sulfide	150	A	A	A	A	A	A	A	A	A	A	A	A	X	X	TVBN
Sodium Sulfite	150	A	A	A	A	A	A	A	B	A	A	A	A	I	I	TVBNS
Sodium Sulphhydrate	100	A	X	X	X	X	A	A	X	A	B	A	I	I	I	T B

\* Fahrenheit to Celsius conversion key: 100°F (38°C), 125°F (52°C), 150°F (66°C), 275°F (135°C) and 500°F (260°C).

This chemical chart is offered as a guide only. There are many variables to be considered with each application. Ratings are for tube polymer only! For explanation of ratings see the initial page of these Chemical Charts in Appendix B. Contact Customer Service for chemicals or polymers not listed at 800-235-4632.

# Chemical Charts

### Rating Scale

**A** = May be used for Continuous Service  
**B** = May be used for Intermittent Service  
**I** = Insufficient data, contact Customer Service  
**X** = Do not use

### Gasket

**T** = Teflon®  
**S** = Silicone  
**N** = Neoprene  
**B** = Nitrile  
**V** = Viton®

Continental ContiTech Chemical Hose / Hose Tube Polymer													Insta-Lock™ Fitting/Metal			
Temp. (°F)*	Fabchem UHMWPE	Gray Flexwing Butyl	Yellow Flexwing Hypalon	Tan Flexwing NR	Orange Flexwing Viton	Flexwing Petroleum Nitrile	Brown Flexwing & ExtremeFlex Brown CPE	Purple Flexwing & ExtremeFlex Purple EPDM	Blue Flexwing & Green XLPE XLPE	Chem One & Viper Alphasyn	HIPER Teflon	316 SS	Aluminum	Brass	Gasket	
<b>S</b>																
Sodium Thiosulfate	150	A	A	A	A	A	A	A	A	A	A	A	I	X	TVBNS	
Stannic Chloride	150	A	A	A	A	I	A	A	A	A	A	X	X	X	T B	
Stannic Sulfide	150	A	A	A	A	I	A	A	A	A	A	I	I	I	TBN	
Stannous Chloride	150	A	A	A	A	I	A	A	B	A	A	A	X	X	T B	
Stannous Sulfide	150	A	A	A	A	I	A	A	A	A	A	I	I	I	T B	
Stearic Acid	100	A	B	X	X	I	A	A	B	A	A	A	B	A	TVB	
Stoddard Solvent	100	A	X	X	X	A	A	A	X	A	B	A	A	I	TVB	
Styrene	100	B	X	X	X	A	X	X	X	X	I	A	A	I	T V	
Sulfamic Acid (>10%)	100	X	A	B	B	I	B	A	I	I	A	I	I	I	TVN	
Sulfonic Acid	100	B	X	X	X	X	X	I	I	B	I	A	I	I	TVN	
Sulfur Dioxide (Liquid)	100	B	B	B	I	X	I	I	I	X	I	A	A	I	T N	
Sulfuric Acid 25%	150	A	A	B	B	I	X	A	A	A	A	A	I	X	TVN	
Sulfuric Acid 93%	100	X	X	B	X	B	X	X	B	A	A	A	I	X	T V	
Sulfuric Acid 93-98%	100	X	X	X	X	B	X	X	X	I	B	A	I	X	T V	
Sulfuric Acid Fuming	100	X	X	X	X	X	X	X	X	X	X	A	I	X	T	
Sulfurous Acid 10%	150	A	A	A	A	I	X	A	A	A	A	A	I	X	T	
Sulfurous Acid 10-75%	100	A	A	A	A	I	X	A	A	A	A	A	I	X	T	
Sulphonate	100	I	X	X	X	X	A	A	X	X	I	I	I	I	B	
<b>T</b>																
Tall Oil	100	A	X	X	X	A	A	I	X	I	I	A	A	X	TVB	
Tallow	150	A	X	X	X	I	A	A	X	I	I	A	A	I	TBNS	
Tannic Acid	150	A	A	A	A	I	B	A	X	I	I	A	A	X	TVBN	
Tar	---	<b>Special Hose Required</b>										A	A	I	I	
Tartaric Acid	150	A	A	A	A	I	A	A	A	A	A	A	A	I	TBN	
Tergitol	100	X	I	I	I	I	I	I	I	I	I	A	I	I	T	
Tertiary Butyl Alcohol	100	A	A	A	A	B	A	A	A	A	A	A	I	I	T B	
Tetrachlorobenzene	100	B	X	X	X	B	X	I	X	B	I	A	I	I	T	
Tetrachloroethane	100	A	X	X	X	A	X	I	X	X	I	A	A	X	T V	
Tetrachloroethylene	100	A	X	X	X	A	X	X	X	A	B	A	A	B	T V	
Tetrachloromethane	100	A	X	X	X	A	X	X	X	X	B	A	A	I	T V	
Tetrachloronaphthalene	100	B	X	X	X	B	X	I	X	X	I	A	I	I	T	
Tetradecanol	100	A	A	A	A	B	A	A	A	A	A	A	I	I	T B	
Tetraethylene Glycol	150	A	A	A	A	A	A	A	A	A	A	A	I	I	TVB	
Tetraethylene Lead	100	X	X	X	X	A	X	X	X	X	I	A	I	I	T V	
Tetrahydrofuran	100	B	X	X	X	X	X	X	X	B	X	A	A	B	T	
THF	100	B	X	X	X	X	X	X	X	B	X	A	A	B	T	
Thionyl Chloride	100	X	I	I	I	I	I	I	I	I	X	A	X	X	T	
Tin Chloride	100	A	A	A	A	I	A	A	A	A	A	A	X	X	TVB	
Tin Tetrachloride	150	B	A	A	A	I	A	A	A	A	A	A	X	X	T B	

\* Fahrenheit to Celsius conversion key: 100°F (38°C), 125°F (52°C), 150°F (66°C), 275°F (135°C) and 500°F (260°C).

This chemical chart is offered as a guide only. There are many variables to be considered with each application. Ratings are for tube polymer only! For explanation of ratings see the initial page of these Chemical Charts in Appendix B. Contact Customer Service for chemicals or polymers not listed at 800-235-4632.

# Chemical Charts

**Rating Scale**
**A** = May be used for Continuous Service

**B** = May be used for Intermittent Service

**I** = Insufficient data, contact Customer Service

**X** = Do not use

**Gasket**
**T** = Teflon®

**N** = Neoprene

**V** = Viton®

**S** = Silicone

**B** = Nitrile

Continental ContiTech Chemical Hose / Hose Tube Polymer													Insta-Lock™ Fitting/Metal			
Temp. (°F)*	Fabchem UHMWPE	Gray Flexwing Butyl	Yellow Flexwing Hypalon	Tan Flexwing NR	Orange Flexwing Viton	Flexwing Petroleum Nitrile	Brown Flexwing & ExtremeFlex Brown CPE	Purple Flexwing & ExtremeFlex Purple EPDM	Blue Flexwing & Green XLPE XLPE	Chem One & Viper Alphasyn	HIPER Teflon	316 SS	Aluminum	Brass	Gasket	
<b>T</b>																
Titanium Tetrachloride	100	B	X	X	X	A	B	X	X	A	B	A	B	X	X	T V
Toluene	100	A	X	X	X	A	X	X	X	B	B	A	A	A	A	T V
Toluidine	100	X	I	I	I	I	I	I	I	I	A	I	I	I	I	T
Toluol	100	A	X	X	X	A	X	X	X	B	B	A	A	A	A	T V
Transformer Oil	100	X	I	I	I	I	I	I	I	I	A	A	I	I	I	T
Transmission Oil "A"	150	B	X	X	X	A	A	I	X	I	I	A	A	A	A	TVB
Tributoxy Ethysulphate	100	I	A	X	X	A	X	X	A	X	I	I	I	I	I	V
Tributyl Amine	100	A	A	X	B	I	B	A	I	A	A	A	I	I	I	T
Tributyl Phosphate	100	A	A	X	X	X	X	X	X	A	I	A	A	I	X	T
Trichlorobenzene	100	B	X	X	X	B	X	X	X	B	I	A	I	A	I	T
Trichloroethane	100	A	X	X	X	A	X	B	X	X	B	A	A	I	I	T V
Trichloroethylene	100	X	X	X	X	A	X	X	X	X	B	A	A	I	I	T V
Trichloropropane	100	A	X	X	X	A	X	I	X	A	I	A	A	X	I	T V
Tricresylphosphate	100	A	A	X	X	A	X	A	A	A	I	A	A	X	I	T V
Tridecanol	100	A	A	A	A	B	A	A	A	A	A	A	I	I	I	T B
Triethanolamine	100	A	A	X	B	X	B	A	A	A	A	A	A	I	X	T B
Triethylamine	100	A	A	X	B	I	B	A	I	A	A	A	A	I	I	TVBN
Triethylene Glycol	150	A	A	A	A	I	A	A	I	A	A	A	A	A	I	T B
Trifluralin (Trefalin)	100	A	X	X	X	A	X	X	X	A	I	A	I	I	I	T V
Triphenyl Phosphate	100	A	A	X	X	I	X	I	I	A	I	A	A	I	I	T
Tripolyphosphate	100	X	I	I	I	I	I	I	I	I	I	A	I	I	I	T
Trisodium Phosphate	150	A	A	A	A	A	A	A	A	A	A	A	A	X	I	TVBNS
Turpentine	100	A	X	X	X	A	A	B	X	A	X	A	A	A	A	T V B
<b>U</b>																
Urea	100	A	A	I	I	I	X	A	I	A	A	A	A	B	I	TVBN
Undecanol	100	B	A	A	A	B	A	A	A	A	A	A	I	I	I	T B
<b>V</b>																
VM. & P. Naptha	100	A	X	X	X	A	A	I	X	A	I	A	I	I	I	TVBS
Vinyl Acetate	100	A	A	B	X	X	X	A	X	A	B	A	A	I	X	T V
Vinyl Benzene	100	A	X	X	X	A	X	X	X	A	I	A	A	I	I	T V
Vinyl Chloride	---	<b>No Hose Recommended For This Application</b>														
Vinyl Ether	---	<b>No Hose Recommended For This Application</b>														
Vinyl Toluene	100	A	X	X	X	A	X	X	X	A	I	A	I	I	I	T V
Vinyl Trichloride	100	A	X	X	X	A	X	X	X	A	B	A	A	I	I	T V
<b>W</b>																
Water	180	A	A	A	A	A	A	A	A	A	A	A	A	I	I	TVBNS
Wax	100	A	X	X	X	X	A	A	X	X	X	A	A	I	I	TVBN
White Oil	100	A	X	X	X	I	A	A	X	I	I	A	I	I	I	TVB
Wood Alcohol	100	A	A	A	A	X	A	A	A	A	A	A	A	I	I	TBNS

\* Fahrenheit to Celsius conversion key: 100°F (38°C), 125°F (52°C), 150°F (66°C), 275°F (135°C) and 500°F (260°C).

This chemical chart is offered as a guide only. There are many variables to be considered with each application. Ratings are for tube polymer only! For explanation of ratings see the initial page of these Chemical Charts in Appendix B. Contact Customer Service for chemicals or polymers not listed at 800-235-4632.



# Chemical Charts

## Rating Scale

**A** = May be used for Continuous Service

**B** = May be used for Intermittent Service

**I** = Insufficient data, contact Customer Service

**X** = Do not use

## Gasket

**T** = Teflon®

**N** = Neoprene

**V** = Viton®

**S** = Silicone

**B** = Nitrile

	Continental ContiTech Chemical Hose / Hose Tube Polymer												Insta-Lock™ Fitting/Metal			
	Temp. (°F)*	Fabchem UHMWPE	Gray Flexwing Butyl	Yellow Flexwing Hypalon	Tan Flexwing NR	Orange Flexwing Viton	Flexwing Petroleum Nitrile	Brown Flexwing & ExtremeFlex Brown CPE	Purple Flexwing & ExtremeFlex Purple EPDM	Blue Flexwing & Green XLPE	Chem One & Viper Alphasyn	HIPER Teflon	316 SS	Aluminum	Brass	Gasket
<b>X</b>																
Xylene (Xylol)	100	X	X	X	X	A	X	X	X	A	B	A	A	I	I	T V
Xylidine	100	B	X	X	X	X	X	X	X	B	B	A	B	A	I	T
<b>Z</b>																
Zinc Carbonate	150	A	A	A	A	A	A	A	A	A	A	A	B	B	X	TVBN
Zinc Chloride	150	A	A	A	A	A	A	A	A	A	A	A	A	X	X	TVBNS
Zinc Chromate	150	A	A	X	I	I	I	A	X	B	I	A	I	I	I	T
Zinc Phosphate	100	A	X	X	X	X	A	A	A	X	I	A	I	I	I	TBNS
Zinc Sulfate	150	A	A	A	A	A	A	A	A	A	A	A	A	X	X	TVBNS

\* Fahrenheit to Celsius conversion key: 100°F (38°C), 125°F (52°C), 150°F (66°C), 275°F (135°C) and 500°F (260°C).

This chemical chart is offered as a guide only. There are many variables to be considered with each application. Ratings are for tube polymer only! For explanation of ratings see the initial page of these Chemical Charts in Appendix B. Contact Customer Service for chemicals or polymers not listed at 800-235-4632.





# Spiraflex Hose Chemical Resistance Guide

## Rating Scale

**A** = May be used for Continuous Service      **B** = May be used for Intermittent Service  
**I** = Insufficient data, contact Customer Service      **X** = Do not use

### Thermoplastic Hose

	Temp. (F°)	Polyurethane Spirathane	PVC Pliovic Plus	TPE Arvac SW	TPR Green Hornet XF
Diesel Oil	70°	I	B	X	X
Diethylamine	70°	I	I	I	I
Diethyl Benzene	70°	I	X	I	X
Diethyl Ketone	70°	I	X	I	I
Diethyl Oxalate	70°	I	X	I	I
Diethyl Phthalate	70°	I	X	I	I
Diethyl Sebacate	70°	I	X	I	I
Diethylene Glycol	70°	I	B	I	I
Diisobutyl Ketone	70°	I	X	I	I
Diisooctyl Adipate	70°	I	X	I	I
Diisooctyl Phthalate	70°	I	X	I	I
Diisodecyl Adipate	70°	I	X	I	I
Diisopropyl Amine	70°	I	X	I	I
Diisopropyl Ketone	70°	I	X	I	I
Dimethyl Amine	70°	I	X	I	I
Dimethyl Benzene	70°	I	X	I	I
Dimethyl Ketone	70°	I	X	I	I
Dimethyl Phthalate	70°	I	X	I	I
Dinitrobenzene	70°	I	X	I	I
Diocetyl Adipate	70°	I	X	I	I
Diocetyl Phthalate	70°	X	X	X	X
Diocetyl Sebacate	70°	I	X	I	I
Diphenyl Phthalate	70°	I	X	I	I
Dipropyl Ketone	70°	I	X	I	I
Disodium Phosphate	70°	A	A	A	B
Divinyl Benzene	70°	I	X	I	I
Dodecyl Benzene	70°	I	X	I	I
<b>E</b>					
Ethanol	70°	A	A	A	A
Ethanol Amine	70°	B	A	B	I
Ethyl Acetate	70°	X	X	X	B
Ethyl Acetoacetate	70°	I	X	I	I
Ethyl Acrylate	70°	x	X	X	I
Ethyl Alcohol	70°	A	A	A	A
Ethyl Benzene	70°	I	X	I	X
Ethyl Butanol	70°	I	A	I	I
Ethyl Butyl Acetate	70°	I	X	I	I
Ethyl Butyl Alcohol	70°	I	A	I	I
Ethyl Butyl Ketone	70°	I	X	I	I
Ethyl Chloride	---	X	X	X	X
Ethyl Dichloride	70°	X	X	X	X
Ethyl Ether	---	X	X	X	X
Ethyl Formate	70°	I	X	I	I
Ethyl Hexyl Acetate	70°	I	X	I	I

### Thermoplastic Hose

	Temp. (F°)	Polyurethane Spirathane	PVC Pliovic Plus	TPE Arvac SW	TPR Green Hornet XF
Ethyl Hexyl Alcohol	70°	I	A	I	I
Ethyl Iodide	70°	x	X	X	X
Ethyl Isobutyl Ether	70°	I	X	I	I
Ethyl Methyl Ketone	70°	X	X	X	X
Ethyl Oxalate	70°	I	X	I	I
Ethyl Phthalate	70°	I	X	I	I
Ethyl Propyl Ether	70°	I	X	I	I
Ethyl Propyl Ketone	70°	X	X	X	I
Ethylene Bromide	70°	X	X	X	X
Ethylene Chloride	70°	X	X	X	X
Ethylene Dibromide	70°	X	X	X	X
Ethylene Dichloride	70°	X	X	X	X
Ethylene Glycol	70°	A	A	A	A
<b>F</b>					
Ferric Bromide	70°	A	A	A	B
Ferric Chloride	70°	A	A	A	A
Ferric Sulfate	70°	A	A	A	A
Ferrous Acetate	70°	A	A	A	I
Ferrous Chloride	70°	A	A	A	B
Ferrous Hydroxide	70°	I	A	A	I
Ferrous Sulfate	70°	A	A	A	A
Fluorine	70°	X	X	X	X
Fluosilicic Acid	70°	A	A	A	B
Formaldehyde	70°	X	X	B	A
Formalin	70°	I	I	A	A
Formic Acid (less than 50%)	70°	B	B	A	A
Formic Acid (more than 50%)	70°	B	X	X	B
Freon* 12	70°	B	B	B	X
Freon* 22	70°	X	X	X	X
Fuel A (ASTM)	70°	A	B	B	I
Fuel B (ASTM)	70°	A	B	X	X
Fuel Oil	70°	A	B	B	X
Furfural	70°	X	X	X	X
<b>G</b>					
Gasoline	70°	X	X	X	X
Glacial Acetic Acid	70°	X	B	I	I
Glycerin	70°	A	A	A	B
Grease	70°	A	A	A	B
<b>H</b>					
Heptane	70°	A	A	X	X
Hexane	70°	A	A	B	X
Hexanol	70°	B	A	B	B

\* Freon\* is a registered trademark of E.I. du Pont de Nemours and Company. 70°F (21°F)





# Spiraflex Hose Chemical Resistance Guide

## Rating Scale

**A** = May be used for Continuous Service      **B** = May be used for Intermittent Service  
**I** = Insufficient data, contact Customer Service      **X** = Do not use

### Thermoplastic Hose

	Temp. (F°)	Polyurethane Spirathane	PVC Pliovic Plus	TPE Arvac SW	TPR Green Hornet XF
Sodium Sulfite	70°	A	A	A	A
Sodium Thiosulfate	70°	A	A	A	A
Stannic Chloride	70°	A	A	A	B
Stannic Sulfide	70°	I	A	I	I
Stannous Chloride	70°	I	A	I	I
Stannous Sulfide	70°	I	A	I	I
Stearic Acid	70°	A	A	A	A
Sulfonic Acid	70°	I	B	I	I
Sulfur Dioxide (Liquid)	70°	X	X	X	X
Sulfuric Acid (Dry)	70°	A	A	A	A
Sulfuric Acid 25%	70°	A	A	A	A
Sulfuric Acid 25-50%	70°	A	A	A	A
Sulfuric Acid 50-96%	70°	X	X	B	B
Sulfuric Acid Fuming	70°	X	X	X	X
Sulfurous Acid 10%	70°	B	B	B	A
Sulfurous Acid 10-75%	70°	X	X	X	X
<b>T</b>					
Tannic Acid	70°	B	B	B	A
Tar	---	I	X	I	I
Tartaric Acid	70°	A	A	A	A
Tertiary Butyl Alcohol	70°	B	B	B	I
Tetrachlorobenzene	70°	I	X	I	I
Tetrachloroethane	70°	I	X	X	X
Tetrachloroethylene	70°	I	X	X	X
Tetraethylene Glycol	70°	I	B	I	I
Tetrachloromethane	70°	I	X	I	X
Tetrachloronaphthalene	70°	I	X	I	X
Tetrahydrofuran	70°	X	X	X	X
Tin Chloride	70°	B	B	B	B
Tin Tetrachloride	70°	B	B	B	B
THF	70°	I	X	I	X
Toluene	70°	X	X	X	X
Toluidine	70°	I	X	I	I
Toluol	70°	X	X	X	X
Transmission Oil "A"	70°	A	B	I	I
Tributyl Phosphate	70°	X	X	X	X
Trichlorobenzene	70°	X	X	X	X
Trichloroethane	70°	I	X	X	X
Trichloroethylene	70°	X	X	X	X
Trichloropropane	70°	I	I	X	X
Triethanolamine	70°	B	B	B	I
Triethylene Glycol	70°	I	B	I	B
Triphenyl Phosphate	70°	B	X	I	I
Trisodium Phosphate	70°	B	B	A	A
Turpentine	70°	B	B	A	X

70°F (21°F)

### Thermoplastic Hose

	Temp. (F°)	Polyurethane Spirathane	PVC Pliovic Plus	TPE Arvac SW	TPR Green Hornet XF
<b>U</b>					
Urea	70°	A	A	A	A
Undecanol	70°	I	A	I	I
<b>V</b>					
V.M. & P. Naptha	70°	I	B	I	I
Vinyl Acetate	70°	I	X	I	X
Vinyl Benzene	70°	I	X	I	X
Vinyl Chloride	---	X	X	X	X
<b>W</b>					
Water	70°	A	A	A	A
Wood Alcohol	70°	B	B	B	A
<b>X</b>					
Xylene (Xylo)	70°	X	X	X	X
Xylidine	70°	I	X	I	I
<b>Z</b>					
Zinc Carbonate	70°	I	A	A	B
Zinc Chloride	70°	A	A	A	B
Zinc Chromate	70°	A	A	A	I
Zinc Sulfate	70°	A	A	A	B

**Air & Multipurpose**  
 General Purpose  
 Heavy Duty  
 Push-on

Chemical Transfer

Cleaning Equipment

**Food**  
 Transfer  
 Washdown

Marine

**Material Handling**  
 Abrasives  
 Bulk Transfer  
 Cement & Concrete

Mining

**Petroleum**  
 Aircraft Fueling  
 Dispensing  
 Dock  
 Transfer

Spray

Steam

Vacuum

LPG Delivery

**Water**  
 Discharge  
 Suction & Discharge  
 Washdown

Welding

Coupling Systems

Equipment

Appendix

# General Information

## Chemical Properties Of Fluoroethylenepropylene (FEP)

### As stated by E.I. du Pont de Nemours

FEP fluorocarbon resins are attacked by certain halogenated complexes containing fluorine including: chlorine trifluoride, bromine trifluoride, iodine pentafluoride and fluorine itself.

FEP is also attacked by such metals as sodium or potassium, especially in their molten states. Great care should be used when mixing finely divided fluorocarbon polymers with finely divided metals, such as aluminum, magnesium or barium, since these can react violently if ignited or heated to a high temperature. Certain complexes of these metals with ammonia or naphthalene (in either solvent) also attack the products. Certain metal hydrides such as boranes, aluminum chloride and certain amines have also been observed to attack fluorocarbon resins at elevated temperatures.

The following materials are inert to FEP:

- › Alcohols
- › Aldehydes
- › Aliphatic Hydrocarbons
- › Anhydrides
- › Aromatics
- › Chlorocarbons
- › Esters
- › Ethers
- › Fluorocarbons
- › Inorganic Bases
- › Inorganic Oxidizing Agents
- › Ketones
- › Organic Acids
- › Salt Solutions
- › Strong Mineral Acids

FEP is a registered trademark with E.I. du Pont de Nemours.

## Method For Steam Cleaning Continental ContiTech Products (Chem One™, Viper™, Fabchem™ and Fabchem™ Arc)

### 5 Important Requirements:

- 1) Hose must be open-ended during steam cleaning.
- 2) Temperature of Steam - Maximum 288°F (142°C).
- 3) Length of Cleaning Time - 5 to 10 minutes...Not more than 15 minutes.
- 4) Care must be taken not to score the tube (liner) with the nozzle or wand end.
- 5) Prolonged steam jet contact on a specific area of the tube (liner) could cause tube damage.

Air &amp; Multipurpose

General Purpose

Heavy Duty

Push-on

Chemical Transfer

Cleaning Equipment

Food

Transfer

Washdown

Marine

Material Handling

Abrasives

Bulk Transfer

Cement &amp; Concrete

Mining

Petroleum

Aircraft Fueling

Dispensing

Dock

Transfer

Spray

Steam

Vacuum

LPG Delivery

Water

Discharge

Suction &amp; Discharge

Washdown

Welding

Coupling Systems

Equipment

Appendix



# General Information

## Infinity™/Paladin® Drop Hose Coupling Procedure

### With Insta-Lock™ Fittings

To make an electrically continuous (EC) assembly, the static wire must be terminated to the couplings as the static dissipating property of the tube alone is not sufficient to meet NAHAD<sup>1</sup> or RMA<sup>2</sup> specifications.

### Infinity™

Locate and pull on the static wire between the fabric plies, bend approximately one inch of the static wire under the tube to make contact with the coupling stem. Grounding staple is also an acceptable method.

### Paladin®

Locate the static wire between the fabric plies. Insert one leg of a grounding staple in the middle of the wire. Ensure that the other leg of the grounding staple is in contact with the coupling stem.

### Attachment Options

Crimp Sleeve—Refer to the Continental ContiTech Products Crimp Assembly Manual for crimp specifications. Current Crimp Sleeve options are listed on page 276 of this catalog. The use of PVC banding coil is not required with crimp sleeve.

**Band Clamps**—PVC banding coils are required when using this method of attachment. Order the appropriate banding coil to match your hose selection. Follow the procedures below when using the banding coils:

1. Insert stem inside hose end.
2. Apply sufficient banding coil in between the hose outer PVC helix to insure complete coverage under the band clamps position.
3. Place the banding coil tightly around the hose to properly fill the cover depressions. Clamp the first band, re-tighten the banding coil and clamp the second band.
4. Please refer to the NAHAD guidelines for detailed instructions.

### Banding coil selection

- › For 2" I.D. hose use 2" I.D. banding coil.
- › For 3" I.D. hose use 3" I.D. banding coil.
- › For 4" I.D. hose use 4" I.D. banding coil.

<sup>1</sup> NAHAD (National Association of Hose and Accessories Distributors)

<sup>2</sup> RMA (Rubber Manufacturers Association)

**Air & Multipurpose**  
General Purpose  
Heavy Duty  
Push-on

Chemical Transfer

Cleaning Equipment

**Food**  
Transfer  
Washdown

Marine

**Material Handling**  
Abrasives  
Bulk Transfer  
Cement & Concrete

Mining

**Petroleum**  
Aircraft Fueling  
Dispensing  
Dock  
Transfer

Spray

Steam

Vacuum

LPG Delivery

**Water**  
Discharge  
Suction & Discharge  
Washdown

Welding

Coupling Systems

Equipment

Appendix

# General Information

## Basic Hose Construction

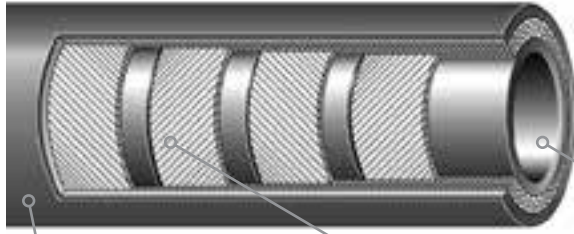

**Cover** The cover is the outermost or visible area of the hose. It is designed to be a protective covering against wear, abrasion, cuts, weather, and the general destructive action encountered in normal service.

**Body or Carcass** The body reinforcement is the supporting structure of the hose. It can range from simple to complex combinations and consists of cord, yarn, fabric, wire, or any combination of these.

**Tube Or Lining** The tube is the inner-most element of a hose and is compounded to provide resistance to the material being carried. With the wide range of rubber compounds available, a hose can be built to withstand abrasive materials, chemicals, oil and a wide variety of other materials.

## The Four Basic Methods Of Hose Construction

Although we make more than 2,000 types of hose for specialized applications, there are only four basic construction methods used. Since each of these four methods embodies certain fundamental characteristics that make it particularly suitable for certain functions, an understanding of these methods may assist you in making the best use of this catalog. Keep in mind that a reference to any one of these types of construction will imply all the characteristics and benefits outlined here plus specific features attained through the proper compounding of rubber, choice materials, and variation in plies and thickness to ensure that each hose is exactly right for the job for which it is designed.

### Type 1

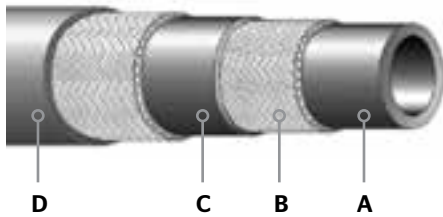

### Type 1: Vertical Braided Hose

- Entire hose length cured in one operation.
- A. Extruded seamless tube.
- B. Seamless reinforcing braids of synthetic textile wire or other material - applied by high speed vertical or horizontal braiders.
- C. Rubber layers between braids establish positive bond between braids when vulcanized.
- D. Extruded, seamless cover.

### Type 2

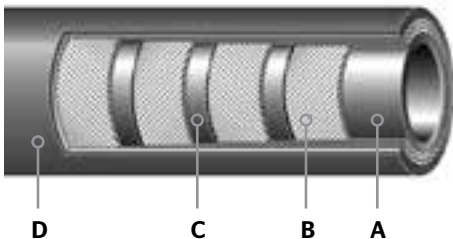

### Type 2: Spiral Hose

- Built by machine with either textile or wire cord reinforcement applied so that each ply is laid at a given angle for maximum dimensional stability.
- A. Extruded or calendered tube.
- B. Reinforcement of synthetic textile wire or other material.
- C. Rubber layers between reinforcement plies to establish positive bond.
- D. Cover.

**Air & Multipurpose**  
General Purpose  
Heavy Duty  
Push-on

Chemical Transfer

Cleaning Equipment

**Food**  
Transfer  
Washdown

Marine

**Material Handling**  
Abrasives  
Bulk Transfer  
Cement & Concrete

Mining

**Petroleum**  
Aircraft Fueling  
Dispensing  
Dock  
Transfer

Spray

Steam

Vacuum

LPG Delivery

**Water**  
Discharge  
Suction & Discharge  
Washdown

Welding

Coupling Systems

Equipment

Appendix

# General Information

## The Four Basic Methods of Hose Construction (continued)

### Type 3

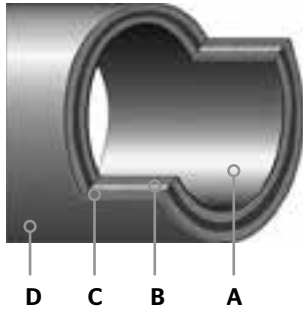

#### Type 3: Hand-built Spiral-plied Hose

Built by hand on a mandrel. Cured under pressure applied from outside by cloth wraps and steam.  
 A. Calendered, or "built-up" tube to fit service.  
 B. Tailor-made spiral-wrapped fabric.  
 C. Wire reinforcement where needed.  
 D. Cover stock of selected gauge and compound.  
 Wrap cured.

### Type 4

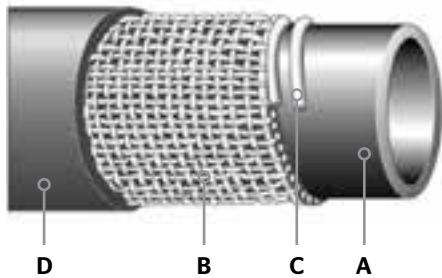

#### Type 4: Knitted Hose

A. Extruded seamless tube.  
 B. Seamless woven textile jacket.  
 C. Interwoven wire helix reinforcement where needed.  
 D. Extruded seamless cover.

## Advantages

### TYPE 1 Braided Hose

Flexible, high resistance to kinking. Cover either smooth or wrapped. Available in long continuous lengths. Excellent tensile strength.

### TYPE 2 Spiral Hose

Extremely flexible. Smooth bore, uniform tube. High strength with long length capability.

### TYPE 3 Hand-built Spiral-plied Hose

Craftsman-built to special requirements. Wide variation in sizes, constructions and materials. Built-in strength to fit most rugged job requirements. Couplings, fittings, nipples, flanges and beaded ends can be built in. Available in lengths up to 50 feet, in sizes up to 18 inches. On larger diameters, consult your Continental ContiTech representative.

**Air & Multipurpose**  
 General Purpose  
 Heavy Duty  
 Push-on

Chemical Transfer

Cleaning Equipment

**Food**  
 Transfer  
 Washdown

Marine

**Material Handling**  
 Abrasives  
 Bulk Transfer  
 Cement & Concrete

Mining

**Petroleum**  
 Aircraft Fueling  
 Dispensing  
 Dock  
 Transfer

Spray

Steam

Vacuum

LPG Delivery

**Water**  
 Discharge  
 Suction & Discharge  
 Washdown

Welding

Coupling Systems

Equipment

Appendix

# General Information

## Definitions of Hose Ends

<b>Air &amp; Multipurpose</b>
General Purpose
Heavy Duty
Push-on
<b>Chemical Transfer</b>
<b>Cleaning Equipment</b>
<b>Food</b>
Transfer
Washdown
<b>Marine</b>
<b>Material Handling</b>
Abrasives
Bulk Transfer
Cement & Concrete
<b>Mining</b>
<b>Petroleum</b>
Aircraft Fueling
Dispensing
Dock
Transfer
<b>Spray</b>
<b>Steam</b>
<b>Vacuum</b>
LPG Delivery
<b>Water</b>
Discharge
Suction & Discharge
Washdown
<b>Welding</b>
<b>Coupling Systems</b>
<b>Equipment</b>



### Plain End

All hose construction elements (including wire, if wire is used as a reinforcing member) are exposed. The hose always has the same inside diameter throughout.

In the case of certain hand-built specifications having wire reinforcement, the wire and fabric reinforcement are not exposed. All vertical spiral hose is available only with plain ends.

Horizontal spiral and wrapped ply machine-built hose is furnished with plain ends unless otherwise specified in the pricebook.

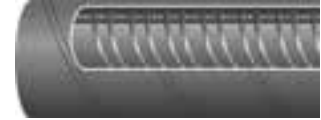

### Built-In Nipple End

The hose end is integrally built around and bonded to the nipple body. The hose reinforcing materials are also anchored to the nipple. The nipples used are generally fabricated from pipe.

Nipples made from standard pipe will be full bore only when pipe 12" and under is used since nominal pipe sizes over 12" are described by pipe OD and not ID.

Available only in hand-built hose constructions.



### Swaged End

Primarily used on petroleum OS&D dock hose as an alternative to built-in nipples. The steel (carbon or stainless) stem/coupling accommodates threaded, slip-on or welded flanged ends. Stem/coupling attached to hose with swaged steel ferrule over the cover.



### Enlarged End

The hose end is enlarged to accommodate the outside diameter of the shank of a fitting plus the depth of the shank. The helical wire is terminated at the enlarged end.

The inside diameter of a "standard" enlarged end is the same dimension as the outside diameter of the same nominal pipe size. (Example-6" ID hose enlarged to 65/8" at the end, handles a 6" size pipe which has a 65/8" OD.) Normally used in hand-built hose constructions.



# General Information

## Definitions of Hose Ends



### Integral Rubber Tapered Nozzle End

The inside diameter and the outside diameter of the hose end are gradually tapered down to form a nozzle. The hose reinforcement is also extended to the end of the nozzle. A rubber end cap is then added to protect the reinforcement and properly shape the nozzle. This type of nozzle is available only in non-wire inserted horizontal spiral and wrapped ply machine-built hose.



### Rubber Beaded End

A flared bell shape, molded as an integral part of the hose. The reinforcing fabric of the hose body is extended beyond the straight portion of the hose and anchored around a circular steel reinforcing ring. A reattachable split malleable iron flange is placed behind the rubber bead to act as a metal bearing surface for bolt heads and nuts. Bolts used to connect mating flanges pass over the outside diameter of the beaded end. Normally used in hand-built hose constructions.



### Integral Rubber Flanged End

Shaped similar to a metal pipe flange. It is molded as an integral part of the hose with the tube, fabric reinforcement (not wire) and cover extending to the outside diameter of the rubber flange. The rubber flange has holes to match customer requirements. In addition, solid metal "backup" rings (drilled to match the rubber flange holes) are always placed behind the rubber flange to provide a metal bearing surface for bolt heads and nuts. Available only in hand-built hose constructions.



### Soft End

The helical wire reinforcement is terminated several inches back from the end of the hose. When a hose has either a corrugated cover or tube or both, a soft end is generally used and always has a smooth inside diameter and outside diameter. Normally used in hand-built hose constructions.



**Air & Multipurpose**  
General Purpose  
Heavy Duty  
Push-on

Chemical Transfer

Cleaning Equipment

**Food**  
Transfer  
Washdown

Marine

**Material Handling**  
Abrasives  
Bulk Transfer  
Cement & Concrete

Mining

**Petroleum**  
Aircraft Fueling  
Dispensing  
Dock  
Transfer

Spray

Steam

Vacuum

LPG Delivery

**Water**  
Discharge  
Suction & Discharge  
Washdown

Welding

Coupling Systems

Equipment

Appendix

# General Information

## Air & Multipurpose

General Purpose

Heavy Duty

Push-on

Chemical Transfer

Cleaning Equipment

Food

Transfer

Washdown

Marine

Material Handling

Abrasives

Bulk Transfer

Cement & Concrete

Mining

Petroleum

Aircraft Fueling

Dispensing

Dock

Transfer

Spray

Steam

Vacuum

LPG Delivery

Water

Discharge

Suction & Discharge

Washdown

Welding

Coupling Systems

Equipment

Appendix

## Hose Testing Methods

Reprinted from RMA hose handbook IP-2 2003

### Safety Warning

Testing can be dangerous and should be done only by trained personnel using proper tools and procedures. Failure to follow such procedures might result in damage to property and/or serious bodily injury.

The Rubber Manufacturers Association (RMA) recognizes, accepts and recommends the testing methods of the American Society for Testing and Materials (ASTM).

Unless otherwise specified, all hose tests are to be conducted in accordance with ASTM Method No. D-380 (latest revision). Where an ASTM D-380 test is not available, another test method should be selected and described in detail.

RMA participates with ASTM under the auspices of the American National Standards Institute (ANSI) in Technical Committee 45 (TC45) of The International Organization for Standardization (ISO) in developing both hose product and hose test method standards. Many of the hose test method standards published by ISO duplicate or closely parallel those shown in ASTM D-380. Many are unique and, in those cases, the RMA may be able to provide the necessary test standard references which may be purchased from the ANSI.

## Hydrostatic Pressure Tests

**Hydrostatic pressure tests are classified as follows:**

### 1. Destructive Type

- a. Burst test                      b. Hold test

#### Destructive Tests

Destructive tests are conducted on short specimens of hose, normally 18 inches (460mm) to 36 inches (915mm) in length and, as the name implies, the hose is destroyed in the performance of the test.

- a. Burst pressure is recorded as the pressure at which actual rupture of a hose occurs.  
b. A hold test, when required, is a means of determining whether weakness will develop under a given pressure for a specified period of time.

### 2. Non-Destructive Type

- |   |  |               |                              |
|---|--|---------------|------------------------------|
| a. Proof pressure test                                  | c. Change in outside diameter<br>or circumference test | e. Rise test  | h. Volumetric expansion test |
| b. Change in length test<br>(elongation or contraction) | d. Warp test   | f. Twist test | g. Kink test                 |

#### Non-Destructive Tests

Non-destructive tests are conducted on a full length of a hose or hose assembly. These tests are for the purpose of eliminating hose with defects which cannot be seen by visual examination or in order to determine certain characteristics of the hose while it is under internal pressure.

- a. A **proof pressure test** is normally applied to hose for a specified period of time. On new hose, the proof pressure is usually 50% of the minimum specified burst except for woven jacket fire hose where the proof pressure is twice the service test pressure marked on the hose (67% of specified minimum burst). Hydrostatic tests performed on fire hose in service should be no higher than the service test pressure referred to above. The regulation of these pressures is extremely important so that no deteriorating stresses will be applied, thus weakening a normal hose.
- b. With some type of hose, it is useful to know how a hose will act under pressure. All change in length tests, except when performed on wire braid or wire spiralled hose, are made with original length measurements taken under a pressure of 10 psi (0.069 MPa). The specified pressure, which is normally the proof pressure, is applied and immediate measurement of the characteristics desired are taken and recorded.

# General Information

## Hose Testing Methods Hydrostatic Pressure Tests (continued)

Percent length change (elongation or contraction) is the difference between the length at 10 psi (0.069 MPa) (except wire braided or wire spiralled) and that at the proof pressure times 100 divided by the length at 10 psi (0.069 MPa). Elongation occurs if the length of the hose under the proof pressure is greater than at a pressure of 10 psi (0.069 MPa). Contraction occurs if the length at the proof pressure is less than at 10 psi (0.069 MPa). In testing wire braided or spiralled hose, the proof pressure is applied and the length recorded. The pressure is then released and, at the end of 30 seconds, the length is measured; the measurement obtained is termed the "original length."

- c. Percent change in outside diameter or circumference** is the difference between the outside diameter or circumference at 10 psi (0.069 MPa) and that obtained under the proof pressure times 100 divided by the outside diameter or circumference at 10 psi (0.069 MPa). Expansion occurs if the measurement at the proof pressure is greater than at 10 psi (0.069 MPa). Contraction occurs if the measurement at the proof pressure is less than at 10 psi (0.069 MPa).
- d. Warp** is the deviation from a straight line drawn from fitting to fitting; the maximum deviation from this line is warp. First, a measurement is taken at 10 psi (0.069 MPa) and then again at the proof pressure. The difference between the two, in inches, is the warp. Normally this is a feature measured on woven jacket fire hose only.
- e. Rise** is a measure of the height a hose rises from the surface of the test table while under pressure. The difference between the rise at 10 psi (0.069 MPa) and at the proof pressure is reported to the nearest 0.25 inch (6.4 mm). Normally, this is a feature measured on woven jacket fire hose only.
- f. Twist** is a rotation of the free end of the hose while under pressure. A first reading is taken at 10 psi (0.069 MPa) and a second reading at proof pressure. The difference, in degrees, between the 10 psi (0.069 MPa) base and that at the proof pressure is the twist. Twist is reported as right twist (to tighten couplings) or left twist. Standing at the pressure inlet and looking toward the free end of a hose, a clockwise turning is right twist and counterclockwise is left twist.
- g. Kink test** is a measure of the ability of woven jacket hose to withstand a momentary pressure while the hose is bent back sharply on itself at a point approximately 18 inches (457 mm) from one end. Test is made at pressures ranging from 62% of the proof pressure on sizes 3 inches (76 mm) and 3.5 inches (89 mm) to 87% on sizes under 3 inches (76 mm). This is a test applied to woven jacket fire hose only.
- h. Volumetric expansion test** is applicable only to specific types of hose, such as hydraulic or power steering hose, and is a measure of its volumetric expansion under ranges of internal pressure.

### Design Considerations

In designing hose, it is customary to develop a design ratio, which is a ratio between the minimum burst and the maximum working pressure.

Burst test data is compiled and the minimum value is established by accepted statistical techniques. This is done as a check on theoretical calculations, based on the strength of reinforcing materials and on the characteristics of the method of fabrication.

Minimum burst values are used as one factor in the establishment of a reasonable and safe maximum working pressure.

**Maximum working pressure is one of the essential operating characteristics that a hose user must know and respect to assure satisfactory service and optimum life.**

It should be noted that design ratios are dependent on more than the minimum burst. The hose technologist must anticipate natural decay in strength of reinforcing materials, and the accelerated decay induced by the anticipated environments in which the hose will be used and the dynamic situations that a hose might likely encounter in service.

Including all considerations, the following recommended design ratios are given for newly manufactured hose:

1. Water hose up to 150 psi WP: 3:1
2. Hose for all other liquids, solid materials suspended in liquids or air, and water hose over 150 psi WP: 4:1
3. Hose for compressed air and other gases: 4:1
4. Hose for liquid media that immediately changes into gas under standard atmospheric conditions: 5:1
5. Steam hose: 10:1

**Air & Multipurpose**  
General Purpose  
Heavy Duty  
Push-on

**Chemical Transfer**

**Cleaning Equipment**

**Food**  
Transfer  
Washdown

**Marine**

**Material Handling**  
Abrasives  
Bulk Transfer  
Cement & Concrete

**Mining**

**Petroleum**  
Aircraft Fueling  
Dispensing  
Dock  
Transfer

**Spray**

**Steam**

**Vacuum**

**LPG Delivery**

**Water**  
Discharge  
Suction & Discharge  
Washdown

**Welding**

**Coupling Systems**

**Equipment**

Appendix

# General Information

## Air & Multipurpose

General Purpose  
Heavy Duty  
Push-on

## Chemical Transfer

## Cleaning Equipment

Food  
Transfer  
Washdown

## Marine

## Material Handling

Abrasives  
Bulk Transfer  
Cement & Concrete

## Mining

## Petroleum

Aircraft Fueling  
Dispensing  
Dock  
Transfer

## Spray

## Steam

## Vacuum

## LPG Delivery

Water  
Discharge  
Suction & Discharge  
Washdown

## Welding

## Coupling Systems

## Equipment

## Appendix

## Electrical Resistance Tests for Hose and Hose Assemblies

### 1.0 Purpose

This procedure specifies methods for performing electrical resistance tests on rubber and/or plastic hose and hose assemblies.

### 2.0 Scope

These procedures are intended to test electrical conductive, antistatic and nonconductive (insulating) hoses, along with electrical continuity or discontinuity between fittings.

## Warning

Hydraulic hoses used on power and telephone mobile equipment should be tested to SAE 100R8 requirements.

### 3.0 Definitions

- 3.1 Antistatic Hose - Antistatic hose constructions are those that are capable of dissipating the static electricity buildup that occurs during the high velocity flow of material through a hose.
- 3.2 Conductive Hose - Conductive hose constructions are those that are capable of conducting an electrical current.
- 3.3 Direct Current (DC): Flow of electrical current in one direction at a constant rate.
- 3.4 Electrical Conductivity: A measure of the ease with which a material is capable of conducting an electrical current.  
Conductivity =  $1/\text{Resistance}$ .
- 3.5 Electrical Resistance: Property of an object to resist or oppose the flow of an electrical current.
- 3.6 Non-Conductive (Insulating) Hose: Non-conductive hose constructions are those that resist the flow of electrical current.
- 3.7 Ohm's Law: The electrical current, I, is equal to the applied voltage, V, divided by the resistance, R. In practical terms, the higher the electrical resistance at a constant voltage, the lower the electrical current flow through an object.
- 3.8 Ohm: The amount of resistance that limits the passage of current to one ampere when a voltage of one volt is applied to it.

### 4.0 Apparatus

- 4.1 Test Instruments: All test instruments shall have a gauge reliability and reproducibility (R&R) of less than 30%. Some instruments made to measure high electrical resistance may have an internal protection circuit built in which will cause test errors in the less than one megohm range.  
During the test, no more than 3 watts (W) shall be dissipated in the specimen, to prevent erroneous results due to effects of temperature. The power dissipated shall be determined by the square of the open-circuit voltage divided by the measured resistance, see formula 1 (Power Dissipation).

$$1) \text{ Power Dissipation} = \frac{(\text{Voltage})^2}{\text{Resistance in ohms}}$$

To determine the electrical resistance of non-conductive hose, the test should be made with an instrument designed specifically for measuring insulation resistance, having a nominal open-circuit voltage of 500 volts D.C., or with any other instrument known to give comparable results. For measuring electrical discontinuity, a 1,000 volt D.C. source may be used instead of a 500 volt D.C. source.

For hoses with a conductive tube or cover, the resistance values obtained may vary with the applied voltage, and errors may occur at low-test voltages. As a starting point, an ohmmeter (9 volts) can be used. For tests requiring measurement of electrical continuity between end fittings or through continuous internal or external bonded wires, the instrument used shall be an ohmmeter (9 volts).

4.2 Electrodes and Contacts: When the test procedure calls for contact with the hose cover, electrodes shall be formed around the outer circumference of the hose as bands 25mm +2mm, 0 mm (1" +1/16", 0") wide by applying silver lacquer/ conductive liquid and metallic copper foil tape (i.e. 3M Scotch Brand) as shown in Figure 6-1. When a conductive silver



# General Information

## Electrical Resistance Tests for Hose and Hose Assemblies (continued)

lacquer (i.e. Colloidal Silver Liquid is available from Ted Pella, Inc. catalogue # 16031) is used, the surface resistance between any two points on a sample of the dried film shall not exceed 100  $\Omega$ . When a conductive liquid is used the electrode contact area shall be completely wetted and shall remain so until the end of the test.

The conductive liquid shall consist of:

- › Anhydrous polyethylene glycol of relative molecular mass 600: 800 parts by mass
- › Water: 200 parts by mass
- › Wetting agent: 1 part by mass
- › Potassium Chloride: 10 parts by mass

When the test procedure calls for contact with the hose tube, it is preferable to use a copper plug of external diameter equal to or slightly greater than the hose ID or a steel hose stem, coated with the conducting liquid, and pushed 25mm (1") into the hose. An alternative for 50mm (2") and above hose would be to apply the conductive silver lacquer onto the hose ID, then insert the plug or hose stem. The electrical leads from the test instrument shall be clean and they should make adequate contact with the metallic copper foil and/or copper plugs/hose stems.

### 5.0 Preparation and Cleaning for Test

The surfaces of the hose shall be clean. If necessary, the hose surface may be cleaned by rubbing with Fuller's earth (magnesium aluminum silicate) and water, followed by a distilled water rinse, and allowing the hose to dry in a non-contaminating environment. Do not use organic materials that attack or swell the rubber, and do not buff or abrade the test surfaces.

The surface of the hose shall not be deformed either during the application of the contacts or during the test. When using test pieces, the supports shall be outside the test length. When using a long length of hose, the hose shall be uncoiled and laid out straight on polyethylene or other suitable insulating material. Care should be taken to ensure that the hose is insulated from any electrical leakage path along the length of the hose.

### 6.0 Test Conditions

For lab testing, the hose or hose assemblies shall be conditioned for at least 16 hours at  $+23^{\circ}\text{C} \pm 2^{\circ}\text{C}$  ( $73.4^{\circ}\text{F} \pm 3.6^{\circ}\text{F}$ ) with a relative humidity not to exceed 70%. However, it is permissible, by agreement between the supplier and the customer, to use the conditions prevailing in the factory, warehouse, or laboratory, provided that the relative humidity does not exceed 70%.

### 7.0 Test Pieces

Prepare three test pieces approximately 300mm (12") long from samples taken at random from a production run or lot. Condition the test pieces per section 6.0.

Place the test piece on blocks of polyethylene, or other insulating material, to provide a resistance of greater than 100  $\Omega$  between the test piece and the surface on which the blocks are supported. Ensure that the leads from the instrument do not touch each other, the hose, or any part except the terminal to which each is connected.

Avoid breathing on the test surfaces and thus creating condensation that may lead to inaccuracies.

### 8.0 Procedure for hoses with conducting tube

Apply the electrodes as specified to the inside surface of the hose at each end of the hose. The edge of the electrode plug shall be coincident with the end of the hose. When using a conductive liquid, care shall be taken to avoid creating a leakage path between the tube and the reinforcement or cover of the hose.

Apply the metal contacts to the electrodes.

Apply the test voltage (9V) and measure the resistance 5 seconds  $\pm$  1 second after the voltage is applied.

Note: In previous editions of the Hose Handbook, this method was referred to as the Plug Method.

### 9.0 Procedure for hose with conducting cover

Apply the electrodes as specified to the outer circumference of the hose at each hose end. See Figure 6-1.

Ensure that contact is maintained with the electrodes around the circumference and that the contact pieces are sufficiently long enough for the two free ends to be held securely by a tensioning clip (see Figure 6-1) such that the fit of the electrodes is as tight as possible.

Apply the metal contacts.

Apply the test voltage (9V) and measure the resistance 5 seconds  $\pm$  1 second after the voltage is applied.

**Air & Multipurpose**  
General Purpose  
Heavy Duty  
Push-on

**Chemical Transfer**

**Cleaning Equipment**

**Food**  
Transfer  
Washdown

**Marine**

**Material Handling**  
Abrasives  
Bulk Transfer  
Cement & Concrete

**Mining**

**Petroleum**  
Aircraft Fueling  
Dispensing  
Dock  
Transfer

**Spray**

**Steam**

**Vacuum**

**LPG Delivery**

**Water**  
Discharge  
Suction & Discharge  
Washdown

**Welding**

**Coupling Systems**

**Equipment**

**Appendix**

# General Information

## Electrical Resistance Tests for Hose and Hose Assemblies (continued)

### Dimensions in Millimeters

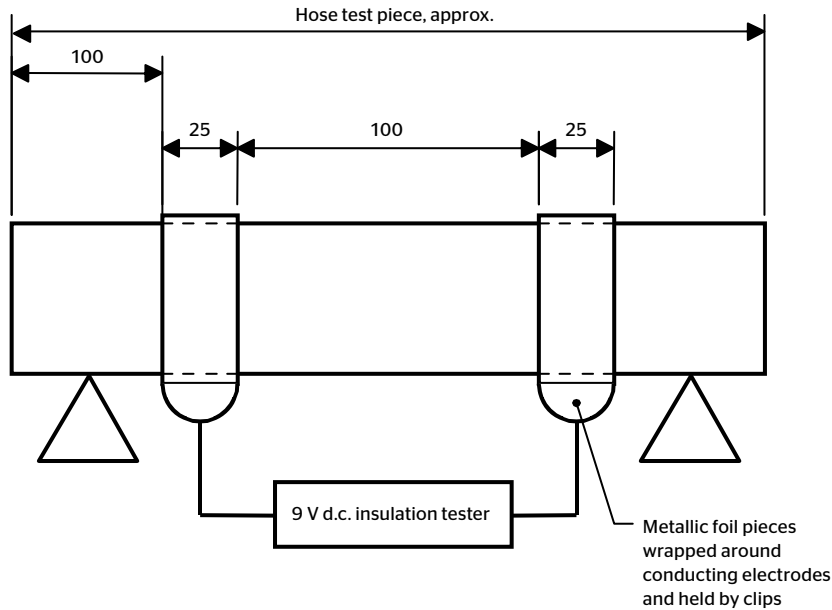

Figure 6-1 - Electrodes and contacts for testing hose

### 10.0 Procedure for hose with conducting or non-conducting compounds throughout

Apply the electrodes as specified on the inside surface at one end of the hose (end A) and on the outside surface at the other end of the hose (end B).

Apply the metal contacts to the electrodes.

Apply the test voltage (9V for conductive compounds and 500V for non-conductive compounds) and measure the resistance 5 seconds + 1 second after the voltage is applied.

Alternative method for non-conductive hose - Nail or "Pot Room" Method

Conduct test as follows:

1. Cut sample hose, 24 inches long
2. Assure that both inside and outside of hose are free of oil, dirt, etc.
3. Pierce sample ends with clean nails, as shown in Fig. 6-2.
4. Connect nails to 1000-volt DC power source and megohm meter or 1000 volt "megger" as shown in Fig. 6-2.
5. Record total resistance, in megohms.
6. Measure "test length" as shown in Fig. 6-2.
7. Divide total resistance by test length to get megohms per inch.

Air &amp; Multipurpose

General Purpose

Heavy Duty

Push-on

Chemical Transfer

Cleaning Equipment

Food

Transfer

Washdown

Marine

Material Handling

Abrasives

Bulk Transfer

Cement &amp; Concrete

Mining

Petroleum

Aircraft Fueling

Dispensing

Dock

Transfer

Spray

Steam

Vacuum

LPG Delivery

Water

Discharge

Suction &amp; Discharge

Washdown

Welding

Coupling Systems

Equipment

Appendix

# General Information

## Electrical Resistance Tests for Hose and Hose Assemblies (continued)

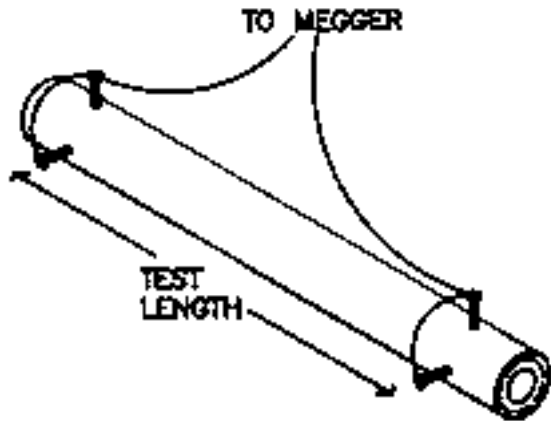

**Figure 6-2 - Nail or “Pot Room” Test**

### 11.0 Procedure for hose assemblies fitted with metal end fittings

When it is required that the resistance of a hose assembly be measured, the leads of the test instrument shall be attached directly to the metal hose shank (threaded end connection, fixed flange, stub end of a floating flange, etc.) of the metal end fittings.

Some hoses, especially thermoplastic hoses, have conductive layers within the hose construction. These hoses shall be tested as assemblies made with fittings and assembly techniques specified by the hose and fitting manufacturer.

Apply the metal contacts to the metal end fittings.

Apply the test voltage (9V) and measure the resistance 5 seconds + 1 second after the voltage is applied.

### 12.0 Procedure for measurement of electrical continuity

In certain types of hose constructions, electrical continuity is provided between the end fittings by means of a continuous wire or wires bonded to each coupling. When the construction is such that there are internal and external wires, the electrical continuity of both wires shall be established.

It is essential that contact resistance between the end fittings and the ohmmeter be minimized.

Apply the metal contacts to the metal end fittings.

Apply the test voltage (9V) and measure the resistance 5 seconds + 1 second after the voltage is applied.

**Air & Multipurpose**  
General Purpose  
Heavy Duty  
Push-on

Chemical Transfer

Cleaning Equipment

**Food**  
Transfer  
Washdown

Marine

**Material Handling**  
Abrasives  
Bulk Transfer  
Cement & Concrete

Mining

**Petroleum**  
Aircraft Fueling  
Dispensing  
Dock  
Transfer

Spray

Steam

Vacuum

LPG Delivery

**Water**  
Discharge  
Suction & Discharge  
Washdown

Welding

Coupling Systems

Equipment

Appendix

# General Information

## Elastomers Used in the Manufacture of “Rubber Type” Products

<b>Continental ContiTech Tradename</b>	<b>Industry Designation</b>	<b>Outstanding Feature</b>	<b>Sample Hose</b>
Alphasyn	Modified Cross-Link Polyethylene	Excellent high-temperature chemical resistance.	Tube compound in Viper chemical transfer hose.
Carbryn	Carboxylated Nitrile	Excellent oil and abrasion resistance, good chemical resistance.	Cover compound on multipurpose hose: Gorilla and Ortac, pressure washer hose: Galvanator and Gauntlet.
Nitrile	Nitrile or Buna-N	Oil, solvent and aromatics resistance.	Tube and cover compound in premium air and multipurpose hose, petroleum transfer hose: Gorilla, Ortac, Flexwing Petroleum.
Chemivic	Buna-N-Vinyl	Oil and abrasion resistant compound. Excellent ozone resistance.	Cover compound air/mp hose. Tube compound in food hose: White Flexwing.
Chemrin	Chlorinated Polyethylene (CPE)	Excellent chemical resistance.	Tube compound chemical hose: Brown Flexwing.
Chlorobutyl	Chlorobutyl	FDA compliant material in food hose. Excellent heat resistance.	Tube compound in food hose and Flexsteel 250 CB Steam Hose.
Flosyn	Viton	Excellent oil and chemical resistance.	Tube compound in Orange Flexwing chemical hose.
Hysunite	Hypalon	Chemical and oil resistant.	Tube compound in chemical transfer hose: Yellow Flexwing.
Nylon	Nylon	Resistant to many paint sprays, lacquers, thinners, and mild chemicals.	Tube compound in NR Paint Spray.
Omeegasyn	EPDM (abrasion-resistant)	Excellent abrasion resistance. Mild chemical resistance.	Cover compound: Viper.
SBR	SBR	Good abrasion resistance.	Tube and cover compound in water suction and discharge hose: Plicord Water S&D.
Pyrosyn	EPDM	Heat resistant	Tube compound in Flexsteel 250 Steam and Whitewater, Cover on Flexsteel 250 Steam and Flexsteel 250 CB Steam

Air &amp; Multipurpose

General Purpose

Heavy Duty

Push-on

Chemical Transfer

Cleaning Equipment

Food

Transfer

Washdown

Marine

Material Handling

Abrasives

Bulk Transfer

Cement &amp; Concrete

Mining

Petroleum

Aircraft Fueling

Dispensing

Dock

Transfer

Spray

Steam

Vacuum

LPG Delivery

Water

Discharge

Suction &amp; Discharge

Washdown

Welding

Coupling Systems

Equipment

Appendix

# General Information

## Elastomers Used in the Manufacture of “Rubber Type” Products

<b>Continental ContiTech Tradename</b>	<b>Industry Designation</b>	<b>Outstanding Feature</b>	<b>Sample Hose</b>
Pliosyn	Ultra High Molecular Weight Polyethylene	Excellent chemical resistance. Good flexibility properties.	Tube compound in Fabchem chemical hose.
Pliovic	Polyvinyl Chloride	Lightweight, flexible and economical.	Pliovic 250, Spiraflex 1600.
Pureten	Natural Rubber	Excellent abrasion resistance, resilient, tensile strength, retains flexibility below 0°F (-18°C) (Poor ozone).	Tube compound in material handling hose: Blucor, Harvest, and Tan Flexwing.
Speclar	Cross-Link Polyethylene	Excellent chemical resistance.	Tube compound in Blue Flexwing chemical hose.
Spirathane	Urethane	Excellent abrasion resistance and good chemical resistance.	Spirathane LD and inner liner of Spirathane HD.
Teflon	Fluorinated Propylene or Teflon	Excellent chemical and petroleum resistance.	Tube compound in Hi-Per Teflon Hose.
TPE	Thermoplastic Elastomer	Heat and/or cold resistant, flexible and resistant to solvents.	Premier.
ChemiTuf Polybutadiene®	Polybutadiene Blend	Good tensile strength, high elongation, abrasion resistance, nonstatic properties.	Tube compound in Plicord Blast, Plicord Dredge Sleeve, Sand Suction
EPDM	EPDM	Heat and/or cold resistant, weather and ozone resistant, mild chemical resistance.	Tube and cover compound in multipurpose hose: Frontier, cover compound on chemical hose: Fabchem.
Weatherex	Butyl	Low permeability to air and gas; outstanding dampening and shock effect.	Tube compound in chemical transfer hose: Yellow Flexwing.
Wingprene	Neoprene (DuPont)	All purpose elastomer; good oil, heat and chemical resistance; very good ozone resistance.	Cover compound in petroleum transfer hose: Super Black Flexwing, and Red Flextra.

**Air & Multipurpose**  
General Purpose  
Heavy Duty  
Push-on

Chemical Transfer

Cleaning Equipment

**Food**  
Transfer  
Washdown

Marine

**Material Handling**  
Abrasives  
Bulk Transfer  
Cement & Concrete

Mining

**Petroleum**  
Aircraft Fueling  
Dispensing  
Dock  
Transfer

Spray

Steam

Vacuum

LPG Delivery

**Water**  
Discharge  
Suction & Discharge  
Washdown

Welding

Coupling Systems

Equipment

Appendix

# General Information

## How to Select the Right Hose

### Air & Multipurpose

General Purpose  
Heavy Duty  
Push-on

### Chemical Transfer

### Cleaning Equipment

Food  
Transfer  
Washdown

### Marine

### Material Handling

Abrasives  
Bulk Transfer  
Cement & Concrete

### Mining

### Petroleum

Aircraft Fueling  
Dispensing  
Dock  
Transfer

### Spray

### Steam

### Vacuum

### LPG Delivery

### Water

Discharge  
Suction & Discharge  
Washdown

### Welding

### Coupling Systems

### Equipment

### Appendix

In order to obtain the best service from any particular hose application, two important conditions must be fulfilled:

1. To select the right hose for the job.
2. To make sure, that after having obtained the right hose, it is fitted correctly and used in a proper manner.

When considering a particular hose application, the following basic factors should be considered:

1. Inside diameter.
2. Outside diameter.
3. Materials being conveyed (e.g., air, water, acids, oils, steam).
4. Precise composition of substance (important in the case of oils, solvents, spraying media, foods, beverages, petroleum products, gases, etc.).
5. Concentration (in the case of chemicals).
6. Maximum temperature of substance.
7. Maximum pressure (including any possible surge or back pressure).
8. Degree of vacuum (in the case of suction hose).
9. External conditions. The scope of this factor is possibly the widest of all and covers such things as:  
Abrasion  
Climactic conditions  
Direct heat  
Radiated heat  
Contamination from oil, grease, solvents, acids, etc  
End loads  
Flexings – degree and cycle  
Crushing conditions  
Kinking conditions
10. Details of couplings (particularly in specialized applications).

### Steam Hose

Air, steam and water hoses are the three types of hose most used in industrial plants. The following instructions apply in general to these types of hose. Since steam service is usually the most severe in the average plant, particular attention is directed to steam hose. In selecting a hose for a steam installation it is important that the type recommended is sufficient to handle the maximum working pressure. Your Continental ContiTech representative will assist in making recommendations.

At elevated temperatures, steam severely affects rubber hose of all types, so it is important that temperature be considered in the choice of a steam hose. High steam temperature and pressure can cause deterioration in certain reinforcing

members used in hose and a relatively small increase in temperature can greatly affect hose performance.

The steam pressure is important in that it determines the minimum temperature condition under which the hose will be used. If the steam is saturated, its temperature is directly related to its pressure. The temperature may be determined from the Saturated Steam Table on page 322. However, if steam is superheated, the degree of superheating must be known to determine the actual temperature which the hose must withstand.

The flex factor takes into consideration the magnitude of the flexing and its time cycle. A flexing that is rapid and continuous, even though of small magnitude, would be considered as severe as flexing that is large in magnitude but with an extremely long time cycle. The degree of flexing is an important factor in the ultimate life of the hose.

Refer to R.M.A. Technical Information Bulletin #1P-11-1.

### Air Hose

Many fine types of air hose, equipped with tough, abrasion-resisting covers are offered tube stocks which will successfully resist oil mist, if present. Where tools are lubricated through hose, only the very best quality air hose with highest grade oil-resisting tube should be used. The recommended working pressure should be sufficient to withstand the maximum pressures encountered.

### Water Hose

In the selection of the correct water hose for any service, the same principles apply as for air and steam hose.

### Suction Hose

Most Continental ContiTech vacuum or suction hose are designed to withstand full vacuum. However, in some of the lighter styles, less than full vacuum is recommended.

Use the information in this catalog to help determine the best hose for your application. To assist your efforts to collect the data necessary to make a proper hose recommendation, use the form on the next page.

# General Information

## Industrial Hose Inquiry/Recommendation

### Size

ID

OD

Hose Length  
(OAL or uncoupled length)

Tolerances

### Temperature

Of Material Being Conveyed  
(High, Low, Ambient)

Of Outside Exposure  
(High, Low, Ambient)

Intermittent?

Constant?

Sub-zero Exposure?

### Application(s)

Indoor and/or Outdoor Use

Intermittent or Continuous Use

Flexibility Required  
(Min. Bend Radius)

Movement  
(Static, Vibrations, Flexing)

External Conditions: Abrasion

Oil

Solvents

Acid

Ozone

Electrical/Static Conductive

Oil Resistance: Tube

Cover

Flame Resistance

Non-contaminating Materials  
Hose Currently in Use

Current Hose Service  
Life/Failure Description

Service Life Desired

### Material(s) Being Conveyed

Solids (Size, Description)

Gaseous (Volatility, Inert)

Liquids (Flammability, Causticity, Acid/Alkaline, Solution/  
Concentration)

Chemical Names (Generic)

### Pressure(s)

Working Pressure (Including Surges)

Burst Pressure

Suction or Vacuum Requirements

Velocity

Impulse

### Ends & Fittings

Factory Applied Fittings:  
Type of threads

Male/Female

Reusable/Nonreusable

Material for Fittings

Built-in Fittings / Ends: Beaded

Flanged

Rubber-Lined

Other

Cut to Length

Crimp Specs/Crimper (Hydraulics)

### Delivery

Leadtime

Quantity

Stock/Nonstock

Special Print

Special Packaging

### Other Information

Customer: \_\_\_\_\_ Date: \_\_\_\_\_

Customer #: \_\_\_\_\_

Ship To: \_\_\_\_\_

Bill To: \_\_\_\_\_

Telephone #: \_\_\_\_\_ Fax#: \_\_\_\_\_

**Air & Multipurpose**  
General Purpose  
Heavy Duty  
Push-on

Chemical Transfer

Cleaning Equipment

**Food**  
Transfer  
Washdown

Marine

**Material Handling**  
Abrasives  
Bulk Transfer  
Cement & Concrete

Mining

**Petroleum**  
Aircraft Fueling  
Dispensing  
Dock  
Transfer

Spray

Steam

Vacuum

LPG Delivery

**Water**  
Discharge  
Suction & Discharge  
Washdown

Welding

Coupling Systems

Equipment

Appendix







# General Information

## Length Conversion Constants

Metric to U.S.	U.S. to Metric
Millimeters x .039370 = inches	Inches x 25.4001 = millimeters
Meters x 39.370 = inches	Inches x .0254 = meters
Meters x 3.2808 = feet	Feet x .30480 = meters
Meters x 1.09361 = yards	Yards x .91440 = meters
Kilometers x 3,280.8 = feet	Feet x .0003048 = kilometers
Kilometers x .62137 = statute miles	Statute Miles x 1.60935 = kilometers
Kilometers x .53959 = nautical miles	Nautical Miles x 1.85325 = kilometers

## Weight Conversion Constants

Metric to U.S.	U.S. to Metric
Grams x 981 = dynes	Dynes x .0010193 = grams
Grams x 15.432 = grains	Grains x .0648 = grams
Grams x .03527 = ounces (Avd.)	Ounces (Avd.) x 28.35 = grams
Grams x .033818 = fluid ounces (water)	Fluid Ounces (Water) x 29.57 = grams
Kilograms x 35.27 = ounces (Avd.)	Ounces (Avd.) x .02835 = kilograms
Kilograms x 2.20462 = pounds (Avd.)	Pounds (Avd.) x .45359 = kilograms
Metric tons (1000Kg) x 1.10231 = net ton (2000 lbs.)	Net ton (2000 lbs.) x .90719 = metric tons (1000Kg)
Metric tons (1000Kg) x .98421 = gross ton (2240 lbs.)	Gross ton (2240 lbs.) x 1.101605 = metric tons (1000Kg)

## Area Conversion Constants

Metric to U.S.	U.S. to Metric
Square millimeters x .00155 = square inches	Square inches x 645.163 = square millimeters
Square centimeters x .155 = square inches	Square inches x 6.45163 = square centimeters
Square meters x 10.76387 = square feet	Square feet x .0929 = square meters
Square meters x 1.19599 = square yards	Square yards x .83613 = square meters
Hectares x 2.47104 = acres	Acres x .40469 = hectares
Square kilometers x 247.104 = acres	Acres x .0040469 = square kilometers
Square kilometers x .3861 = square miles	Square miles x 2.5899 = square kilometers

### Air & Multipurpose

General Purpose

Heavy Duty

Push-on

Chemical Transfer

Cleaning Equipment

Food

Transfer

Washdown

Marine

Material Handling

Abrasives

Bulk Transfer

Cement & Concrete

Mining

Petroleum

Aircraft Fueling

Dispensing

Dock

Transfer

Spray

Steam

Vacuum

LPG Delivery

Water

Discharge

Suction & Discharge

Washdown

Welding

Coupling Systems

Equipment

Appendix

# General Information

## Properties of Saturated Steam

The steam pressure is important because it determines the minimum temperature condition under which the hose will be used. The operating temperature is a very important factor in selecting a steam hose as a relatively small increase in temperature can greatly reduce the hose life.

Pressure-Temperature Equivalents of Saturated Steam

Lbs. per sq. in. Pressure	Temperature		Lbs. per sq. in. Pressure	Temperature	
	°F	°C		°F	°C
0	212.0	100.0	110	344.1	173.4
5	227.1	108.4	115	347.2	175.1
10	239.4	115.2	120	350.1	175.7
15	249.8	121.0	125	352.9	178.3
20	258.8	126.0	130	355.6	179.8
22	261.2	127.8	135	358.3	181.3
24	265.3	129.6	140	360.9	182.7
26	268.3	131.3	145	363.4	184.1
28	271.2	132.9	150	365.9	185.5
30	274.1	134.5	155	368.2	186.8
32	276.8	136.0	160	370.6	188.1
34	279.3	137.4	165	373.9	189.4
36	281.8	138.8	170	375.3	190.7
38	284.4	140.2	175	377.4	191.9
40	286.7	141.5	180	379.6	193.1
42	289.0	142.8	185	381.7	194.3
44	291.2	144.0	190	383.7	195.4
46	293.5	145.3	195	385.9	196.6
48	295.5	146.4	200	387.9	197.7
50	294.7	147.6	205	398.8	198.8
52	299.9	148.7	210	391.6	199.8
54	301.6	149.8	215	392.9	200.5
56	303.6	150.9	220	395.4	201.7
58	308.4	151.9	225	397.2	202.9
60	307.4	153.0	230	399.0	203.9
62	309.2	154.0	235	400.7	204.8
64	310.8	154.9	240	402.5	205.8
66	312.6	155.9	245	404.2	206.8
68	314.2	156.8	250	406.1	207.8
70	316.0	157.0	255	407.7	208.7
72	317.7	158.7	260	409.4	209.7
74	319.3	159.6	265	411.0	210.6
76	320.9	160.5	270	412.6	211.4
78	322.3	161.3	275	414.2	202.3
80	323.8	162.1	280	415.7	213.2
85	327.6	164.2	300	421.0	216.1
90	331.2	166.2	350	436.5	224.7
95	334.6	168.1			
100	337.8	169.9			
105	341.1	171.7			

**Air & Multipurpose**  
General Purpose  
Heavy Duty  
Push-on

Chemical Transfer

Cleaning Equipment

**Food**  
Transfer  
Washdown

Marine

**Material Handling**  
Abrasives  
Bulk Transfer  
Cement & Concrete

Mining

**Petroleum**  
Aircraft Fueling  
Dispensing  
Dock  
Transfer

Spray

Steam

Vacuum

LPG Delivery

**Water**  
Discharge  
Suction & Discharge  
Washdown

Welding

Coupling Systems

Equipment

Appendix

# General Information

## Flow Data

This table may be used to determine the pressure loss in hose connected to rock drills and pneumatic tools. It is correct for hose with smooth inside lining. Hose with rough inside lining may have a friction loss of as much as 50% greater than the figures given in the table.

### Air Flow Pressure Loss - Pulsating flow

Size Of Hose	Gauge Pressure at Line	Cubic feet free air per minute passing through 50 foot lengths of hose Loss of pressure in pounds per square inch - 50 foot hose length																
		20	30	40	50	60	70	80	90	100	110	120	130	140	150			
Air & Multipurpose General Purpose Heavy Duty Push-on	50	1.8	5.0	10.1	18.1													
	½ In. With Couplings At Each End	60	1.3	4.0	8.4	14.8	23.4											
		70	1.0	3.4	7.0	12.4	20.0	28.4										
		80	.9	2.8	6.0	10.8	17.4	25.2	34.6									
		90	.8	2.4	5.4	9.5	14.8	22.0	30.5	41.0								
		100	.7	2.3	4.8	8.4	13.3	19.3	27.2	36.6								
Material Handling Abrasives Bulk Transfer Cement & Concrete	110	.6	2.0	4.3	7.6	12.0	17.6	24.6	33.3	44.5								
	Mining	50	.4	.8	1.5	2.4	3.5	4.4	6.5	8.5	11.4	14.2						
		60	.3	.6	1.2	1.9	2.8	3.8	5.2	6.8	8.6	11.2						
		¾ In. with Couplings at Each End	70	.2	.5	.9	1.5	2.3	3.2	4.2	5.5	7.0	8.8	11.0				
			80	.2	.5	.8	1.3	1.9	2.8	3.6	4.7	5.8	7.2	8.8	10.6			
			90	.2	.4	.7	1.1	1.6	2.3	3.1	4.0	5.0	6.2	7.5	9.0			
100			.2	.4	.6	1.0	1.4	2.0	2.7	3.5	4.4	5.4	6.6	7.9	9.4	11.1		
Petroleum Aircraft Fueling Dispensing Dock Transfer	110	.1	.3	.5	.9	1.3	1.8	2.4	3.1	3.9	4.9	5.9	7.1	8.4	9.9			
	Spray	50	.1	.2	.3	.5	.8	1.1	1.5	2.0	2.6	3.5	4.8	7.0				
		60	.1	.2	.3	.4	.6	.8	1.2	1.5	2.0	2.6	3.3	4.2	5.5	7.2		
		1 In. with Couplings at Each End	70		.1	.2	.4	.5	.7	1.0	1.3	1.6	2.0	2.5	3.1	3.8	4.7	
			80		.1	.2	.3	.5	.7	.8	1.1	1.4	1.7	2.0	2.4	2.7	3.5	
			90		.1	.2	.3	.4	.6	.7	.9	1.2	1.4	1.7	2.0	2.4	2.8	
100				.1	.2	.2	.4	.5	.6	.8	1.0	1.2	1.5	1.8	2.1	2.4		
Vacuum	110		.1	.2	.2	.3	.4	.6	.7	.9	1.1	1.3	1.5	1.8	2.1			
	LPG Delivery	50			.1	.2	.2	.3	.4	.5	.7	1.1						
		60				.1	.2	.3	.3	.5	.6	.8	1.0	1.2	1.5			
		1¼ In. with Couplings at Each End	70				.1	.2	.2	.3	.4	.4	.5	.7	.8	1.0	1.3	
			80					.1	.2	.2	.3	.4	.5	.6	.7	.8	1.0	
			90					.1	.2	.2	.3	.3	.4	.5	.6	.7	.8	
100								.1	.2	.2	.3	.4	.4	.5	.6	.7		
Water Discharge Suction & Discharge Washdown	110						.1	.2	.2	.3	.3	.4	.5	.5	.6			
	Coupling Systems	50							.1	.2	.2	.2	.3	.3	.4	.5	.6	
		60								.1	.2	.2	.2	.3	.3	.4	.5	
		1½ In. with Couplings at Each End	70									.1	.2	.2	.2	.3	.3	.4
			80										.1	.2	.2	.2	.3	.4
			90											.1	.2	.2	.2	.3
100														.1	.2	.2	.2	
Equipment	110													.1	.2	.2	.2	

For longer or shorter lengths of hose, the friction loss is proportional to the length, e.g., for 25 feet, half of the above; for 150 feet, three times the above, etc.

# General Information

## Flow Data (continued)

### Water Flow Pressure Loss (psi per 100 feet of hose)

Flow of water in U.S. gal. per min.	Flow of water in cu. feet per sec.	Actual Internal Diameter (in.)									
		1/2	5/8	3/4	1	1 1/4	1 1/2	2	2 1/2	3	
0.5	.001	0.4									
1.5	.003	3.02	1.01	0.42							
2.5	.005	7.75	2.58	1.08							
5	.011	27.8	9.27	3.86	0.95	0.32	0.13				
10	.022	99.5	33.2	13.8	3.38	1.14	0.47	0.12			
15	.033		71.0	29.6	7.25	2.45	1.01	0.25	0.08		
20	.044		121.0	50.3	12.4	4.15	1.71	0.42	0.14		
25	.055			76.5	18.7	6.34	2.60	0.64	0.22		
30	.066			108.0	26.5	8.96	3.68	0.90	0.30	0.13	
35	.077			142.0	34.8	11.8	4.83	1.18	0.40	0.17	
40	.088				44.7	15.1	6.20	1.52	0.51	0.21	
45	.099				55.0	18.6	7.65	1.87	0.63	0.26	
50	.110				67.5	22.8	9.35	2.28	0.78	0.32	
60	.132				94.3	31.8	13.1	3.19	1.08	0.45	
70	.154				126.0	42.5	17.5	4.25	1.44	0.60	
80	.176					54.6	22.5	5.48	1.86	0.77	
90	.198					67.5	27.8	6.80	2.30	0.95	
100	.223					81.5	33.5	8.19	2.78	1.15	
125	.278					124.0	50.6	12.4	4.20	1.73	
150	.334						72.1	17.6	6.97	2.46	
175	.390						94.5	23.1	7.83	3.23	
200	.446						122.0	29.6	10.1	4.15	
225	.501							36.8	12.5	5.15	
250	.557							44.6	15.2	6.28	
275	.613							53.3	18.1	7.45	
300	.688							62.5	21.2	8.75	
325	.724							72.5	24.6	10.2	
350	.780							83.2	28.2	11.7	
375	.836							94.5	32.1	13.3	
400	.891							107.0	36.2	14.9	
450	1.00								44.9	18.6	
500	1.11								54.5	22.5	
600	1.34								76.5	31.6	
700	1.56								102.0	42.1	
800	1.78								131.0	53.9	
900	2.00									66.8	
1000	2.23									81.4	
1100	2.45									97.0	
1200	2.67									114.0	
1300	2.90									132.0	
1400	3.12										
1500	3.34										
1600	3.56										
1800	4.01										
2000	4.45										

Note: The pressure loss experienced by a liquid flowing through a hose depends on the rate of flow, the viscosity of the liquid, the hose ID, the smoothness of the tube and the hose length. This chart shows the relationship between rate of flow, ID, and pressure loss for water at 68°F (20°C) with a viscosity of one centipoise. The pressure is directly proportional to the length of the hose, therefore, the data shown can be easily extended by use of proportions, e.g., the pressure drop for 50 feet of hose length is half that for 100 feet.

Air & Multipurpose  
General Purpose  
Heavy Duty  
Push-on

Chemical Transfer

Cleaning Equipment

Food  
Transfer  
Washdown

Marine

Material Handling  
Abrasives  
Bulk Transfer  
Cement & Concrete

Mining

Petroleum  
Aircraft Fueling  
Dispensing  
Dock  
Transfer

Spray

Steam

Vacuum

LPG Delivery

Water  
Discharge  
Suction & Discharge  
Washdown

Welding

Coupling Systems

Equipment

Appendix

# General Information

## Flow Data (continued)

### Water Flow Pressure Loss (PSI per 100 feet of hose)

	Flow of water in U.S. gal. per min.	Flow of water in cu. feet per sec.	Actual Internal Diameter (in.)								
			4	6	8	10	12	14	16		
<b>Air &amp; Multipurpose</b> General Purpose Heavy Duty Push-on											
Chemical Transfer											
Cleaning Equipment	100	.223	.26								
	125	.278	.40								
<b>Food</b>	150	.334	.54								
Transfer	175	.390	.70	.10							
Washdown	200	.446	.90	.13							
	225	.501	1.08	.16							
<b>Marine</b>	250	.557	1.34	.19							
	275	.613	1.60	.24							
	300	.668	1.84	.28							
<b>Material Handling</b>	325	.724	2.04	.33							
Abrasives	350	.780	2.30	.37							
Bulk Transfer	375	.836	2.80	.44							
Cement & Concrete	400	.891	3.10	.49							
	425	.947	3.40	.54							
<b>Mining</b>	450	1.00	3.80	.60							
	475	1.06	4.25	.70							
	500	1.11	4.60	.78	.16						
<b>Petroleum</b>	550	1.22	5.60	.93	.18						
Aircraft Fueling	600	1.34	6.60	1.10	.23						
Dispensing	650	1.45	7.60	1.30	.27						
<b>Dock</b>	700	1.56	8.60	1.50	.30						
Transfer	750	1.67	9.60	1.70	.34						
	800	1.78	10.80	1.90	.39						
<b>Spray</b>	850	1.89	12.00	2.20	.44						
	900	2.00		2.40	.49						
<b>Steam</b>	950	2.12		2.60	.54						
	1000	2.23		2.80	.59	.19					
	1100	2.45		3.20	.66	.23					
<b>Vacuum</b>	1200	2.67		3.70	.74	.27					
	1300	2.90		4.50	.88	.31					
<b>LPG Delivery</b>	1400	3.12		5.30	1.10	.35	.15				
	1500	3.34		6.20	1.25	.40	.17				
	1600	3.56		7.00	1.40	.45	.19				
<b>Water</b>	1800	4.01		8.80	1.80	.54	.24				
Discharge	2000	4.45		16.50	2.20	.64	.29	.14			
<b>Suction &amp; Discharge</b>	2500	5.57			3.40	.98	.42	.21			
Washdown	3000	6.68			4.50	1.40	.58	.29	.14		
	3500	7.80			6.20	1.90	.79	.39	.18		
	4000	8.91			8.20	2.40	1.00	.50	.23		
<b>Welding</b>	4500	10.03			10.20	3.00	1.25	.62	.28		
	5000	11.14				3.80	1.50	.74	.34		
<b>Coupling Systems</b>	6000	13.37				5.20	2.10	1.10	.46		
	7000	15.60				7.00	2.80	1.40	.62		
	8000	17.82				9.20	3.70	1.80	.80		
<b>Equipment</b>	9000	20.05				11.50	4.60	2.30	1.00		
	10000	22.28					5.70	2.80	1.25		
	12000	26.74					6.70	3.70	1.70		
	14000	31.19					10.00	5.00	2.40		
	16000	35.65					13.50	6.80	3.30		
	18000	40.10						8.80	4.40		
	20000	44.56						11.00	5.50		



# General Information

## Fluid Velocity vs. Flow Rate

The graph below illustrates the fluid velocity for flow rates up to 10,000 GPM for hose from 1" through 10" ID

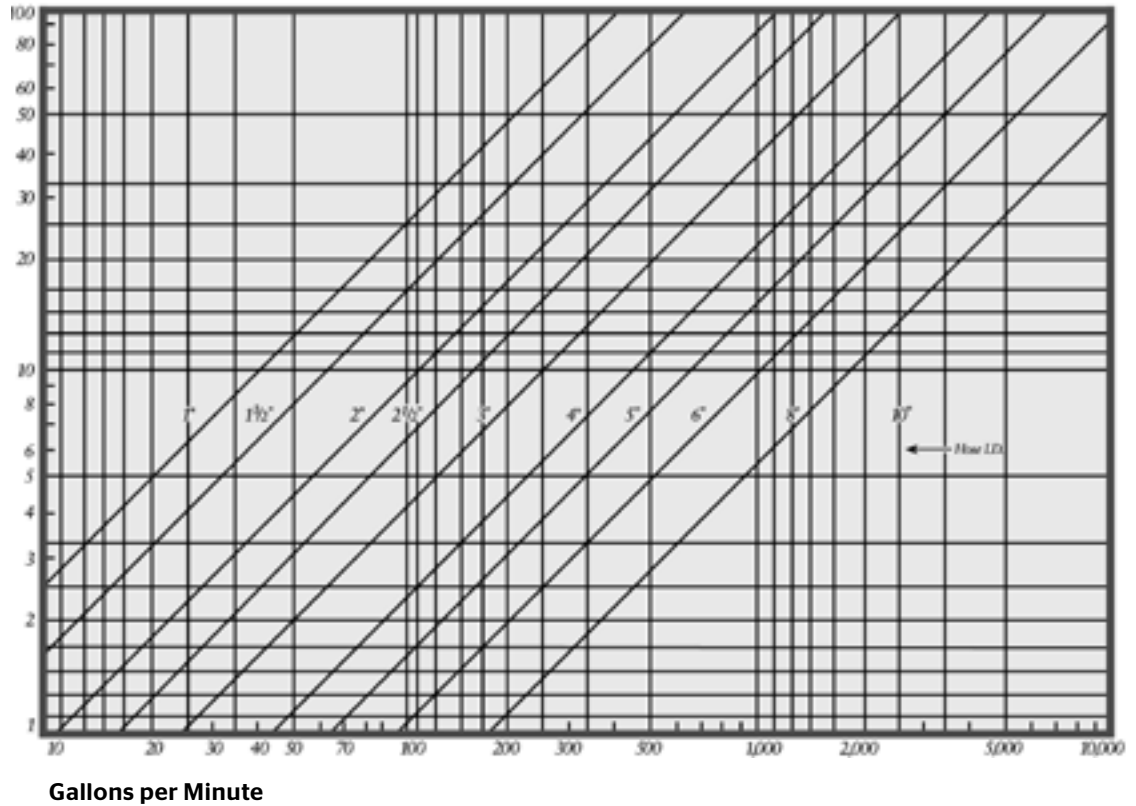

Air & Multipurpose  
General Purpose  
Heavy Duty  
Push-on

Chemical Transfer

Cleaning Equipment

Food  
Transfer  
Washdown

Marine

Material Handling  
Abrasives  
Bulk Transfer  
Cement & Concrete

Mining

Petroleum  
Aircraft Fueling  
Dispensing  
Dock  
Transfer

Spray

Steam

Vacuum

LPG Delivery

Water  
Discharge  
Suction & Discharge  
Washdown

Welding

Coupling Systems

Equipment

Appendix



# General Information

## RMA Oil and Gasoline Resistance

Rubber hose is used to convey petroleum products both in the crude and refined stages. The aromatic content of refined gasoline is often adjusted to control the octane rating. The presence of aromatic hydrocarbons in this fuel generally has a greater effect on rubber components than do aliphatic hydrocarbons. Aromatic materials in contact with rubber tend to soften it and reduce its physical properties. For long-lasting service, the buyer of gasoline hose should inform the hose manufacturer of the aromatic content of the fuel to be handled so that the proper tube compound can be recommended for the specific application.

The effects of oil on rubber depend on a number of factors that include the type of rubber compound the composition of the oil, the temperature and time of exposure. Rubber compounds can be classified as to their degree of oil resistance based on their physical properties after exposure to a standard test fluid. In this RMA classification, the rubber samples are immersed in IRM 903 oil at 212°F (100°C) for 70 hours. (See ASTM Method D-471 for a detailed description of the oil and the testing procedure.) As a guide to the user of hose in contact with oil, the oil resistance classes and a corresponding description are listed.

(Reprinted From RMA Hose Handbook IP-2 2003 Edition)

### Physical Properties After Exposure to Oil

	Volume Change Maximum	Tensile Strength Retained
Class A (High Oil Resistance)	+25%	80%
Class B (Medium Oil Resistance)	+65%	50%
Class C (Limited Oil Resistance)	+100%	40%

**Air & Multipurpose**  
General Purpose  
Heavy Duty  
Push-on

**Chemical Transfer**

**Cleaning Equipment**

**Food**  
Transfer  
Washdown

**Marine**

**Material Handling**  
Abrasives  
Bulk Transfer  
Cement & Concrete

**Mining**

**Petroleum**  
Aircraft Fueling  
Dispensing  
Dock  
Transfer

**Spray**

**Steam**

**Vacuum**

**LPG Delivery**

**Water**  
Discharge  
Suction & Discharge  
Washdown

**Welding**

**Coupling Systems**

**Equipment**

**Appendix**

# General Information

## Food Hose Standards

### FDA Compliant

All Continental ContiTech hoses having the "FDA" designation have tubes made with FDA/USDA compliant materials. The requirements for rubber tubes are described in the Code of Federal Regulations standard 21 CFR 177.2600 while plastic tubes are described in 21 CFR 175.300.

### NSF 61

Clear Pliovic® tubes are certified as meeting the NSF 61 potable water standard.

### 3-A Sanitary

All Continental ContiTech rubber hoses having the "3-A" designation meet the requirements of the dairy industrial standard described in 3-A Sanitary Standard 18-03, Class III which determines rubber materials suitable for temperature of exposure to product up to 120°F (49°C) and temperature of exposure to chemical solutions used in cleaning and bacterial treatment up to 180°F (82°C).

All Continental ContiTech plastic hoses having the "3-A" designation meet the requirements of the dairy industrial standard described in 3-A Sanitary Standard 20-20 and are recommended for transmission of raw and pasteurized milk and other high water content dairy items.

In order to ensure compliance with the above standards, all Continental ContiTech hoses shall be thoroughly cleansed prior to their first use in accordance with good manufacturing and use practices.

#### Air & Multipurpose

General Purpose

Heavy Duty

Push-on

#### Chemical Transfer

#### Cleaning Equipment

#### Food

Transfer

Washdown

#### Marine

#### Material Handling

Abrasives

Bulk Transfer

Cement & Concrete

#### Mining

#### Petroleum

Aircraft Fueling

Dispensing

Dock

Transfer

#### Spray

#### Steam

#### Vacuum

#### LPG Delivery

#### Water

Discharge

Suction & Discharge

Washdown

#### Welding

#### Coupling Systems

#### Equipment

#### Appendix

# General Information

## Precautions for Welding Hose Use

### Foreword

This bulletin is issued to alert dealers and users of welding hose that special hose may be necessary for use with certain fuel gases.

### Scope

This bulletin relates to welding hose manufactured in conformance to RMA/CGA specification or to welding hose conforming to individual manufacturer or user specifications.

### Caution

The fuel gases listed below are recorded to alert welding hose users to a potential hazard with these or similar gases. It should be noted that no condemnation of any of the gases listed is intended. The purpose is to advise against the use of hose that may not be designed for a particular gas or pressure. A user of any fuel gas is urged to relate the type of gas along with the expected working pressure (regulator setting) to the hose manufacturer for a specific hose recommendation.

### Alert Listing

These and similar fuel gases may damage some grades or types of welding hose:

#### Apachi, Flamex, Mapp, Propane, Propylene

Use of the indicated or similar fuel gases at regulator settings above 40 psi may be particularly hazardous.

Users are also alerted against the use of acetylene at any pressure above 15 psi.

### In-service Caution

The user is first cautioned to shut off the gas at the torch and then at the regulator or supply source when the torch will not be used for periods in excess of 30 minutes, in order to limit permeation of gas through the hose wall.

The user is further cautioned not to shut off the fuel gas at the regulator or supply source first as a flashback may result and thereby damage the hose.

Adequate ventilation must be provided in confined areas where fuel gas is being used to prevent the accumulation or concentration of gas that could be explosive or otherwise harmful to personnel.

### Warning

The Use of Certain Fuel Gases May Damage Welding Hose and Lead to Fires and Explosions.

**Air & Multipurpose**  
General Purpose  
Heavy Duty  
Push-on

Chemical Transfer

Cleaning Equipment

**Food**  
Transfer  
Washdown

Marine

**Material Handling**  
Abrasives  
Bulk Transfer  
Cement & Concrete

Mining

**Petroleum**  
Aircraft Fueling  
Dispensing  
Dock  
Transfer

Spray

Steam

Vacuum

LPG Delivery

**Water**  
Discharge  
Suction & Discharge  
Washdown

Welding

Coupling Systems

Equipment

Appendix

# General Information

## Production Run Minimum Requirements Key

Order Code Prefix	Manufacturing Facility	Size (ID)	Construction	Minimum Production Run
<b>Air &amp; Multipurpose</b> General Purpose Heavy Duty Push-on		3/16"-2"	Textile Reinforcement	2,500 feet
		3/16"-2"	Wire Reinforcement	2,500 feet
Chemical Transfer		3/16"-1/2"	Textile Reinforcement	5,000 feet
		5/8"-2"		2,500 feet
Cleaning Equipment	Norfolk	3/16"-1/2"	Textile Reinforcement	2,500 feet
		5/8"-2"		2,500 feet
<b>Food</b> Transfer Washdown	Norfolk	3/16"-1/2"	Textile Reinforcement	2,500 feet
		5/8"-2"		2,500 feet
Marine	Cosmoflex	11/4"-11/2"		4,500 feet
		2"		4,500 feet
		2 1/2"-3"		4,500 feet
<b>Material Handling</b> Abrasives Bulk Transfer Cement & Concrete		4"		3,300 feet
		6"		1,800 feet
		3/16"-1/2"	Wire Reinforcement	5,000 feet
Mining	Norfolk	5/8"-2"		2,500 feet
		1/4"-3/8"		15,000 feet
<b>Petroleum</b> Aircraft Fueling Dispensing Dock Transfer	Cosmoflex	1/2"-1"		5,000 feet
		1"-12"	Hand Built	Built to length, Max. 100'
		12"-18"	Hand Built	Built to length, Max. 50'
Spray	Granford	1/2"-6 5/8"	Ply or Ply with Helic Wire	400 feet increments <sup>1</sup>
		1/2"-6 5/8"	Ply or Ply with Helic Wire	400 feet increments <sup>1</sup>
		1/2"-6 5/8"	Ply or Ply with Helic Wire	400 feet increments <sup>1</sup>
Steam	Granford	1/2"-6 5/8"	Ply or Ply with Helic Wire	400 feet increments <sup>1</sup>
		3/16"-1 1/2"		5,000 feet
		3/4"-1"		3,000 feet
Vacuum	Cosmoflex	1 1/4"-2"		2,000 feet
		2 1/2"-3"		1,000 feet
		4"		700 feet
LPG Delivery		5"		500 feet
		6"		300 feet
		7"		200 feet
<b>Water</b> Discharge Suction & Discharge Washdown		8"-10"		200 feet
		3/16"-1/2"		5,000 feet
		5/8"-1"		5,000 feet
Welding	Mt. Pleasant	1 1/4"-2"		5,000 feet
		3/16"-1/2"		5,000 feet
Coupling Systems	Mt. Pleasant	5/8"-1"		5,000 feet
		1 1/4"-2"		5,000 feet
Equipment		3/16"-1/2"		5,000 feet
		5/8"-1"		5,000 feet
		1 1/4"-2"		5,000 feet

Note: Certain special manufacturing items may require longer minimum runs.

Samples: Contact Customer Service for sample availability.

<sup>1</sup>Minimum production runs are a guide only, they are subject to change without notification.

<sup>2</sup>Granford hoses with ply/helic wire construction in 6" ID and above require a 200' increment production run.

# General Information

## Care, Maintenance and Storage

Reprinted from RMA Hose Handbook IP-2 Seventh Edition 2003

Hose has a limited life and the user must be alert to signs of impending failure, particularly when the conditions of service include high working pressures and/or the conveyance or containment of hazardous materials. The periodic inspection and testing procedures described here provide a schedule of specific measures which constitute a minimum level of user action to detect signs indicating hose deterioration or loss of performance before conditions leading to malfunction or failure are reached.

### Safety Warning:

Failure to properly follow the manufacturer's recommended procedures for the care, maintenance and storage of a particular hose might result in its failure to perform in the manner intended and might result in possible damage to property and serious bodily injury.

General instructions are also described for the proper storage of hose to minimize deterioration from exposure to elements or environments which are known to be deleterious to rubber products. Proper storage conditions can enhance and extend substantially the ultimate life of hose products.

### General Care and Maintenance

Hose should not be subjected to any form of abuse in service. It should be handled with reasonable care. Hose should not be dragged over sharp or abrasive surfaces unless specifically designed for such service. Care should be taken to protect hose from severe end loads for which the hose or hose assembly were not designed. Hose should be used at or below its rated working pressure; any changes in pressure should be made gradually so as not to subject the hose to excessive surge pressures. Hose should not be kinked or run over by equipment. In handling large size hose, dollies should be used whenever possible; slings or handling rigs, properly placed, should be used to support heavy hose used in oil suction and discharge service.

### General Test & Inspection Procedures

An inspection and hydrostatic test should be made at periodic intervals to determine if a hose is suitable for continued service. A visual inspection of the hose should be made for loose covers, kinks, bulges or soft spots which might indicate broken or displaced reinforcement. The couplings or fittings should be closely examined and, if there is any sign of movement of the hose from the couplings, the hose should be removed from service.

The periodic inspection should include a hydrostatic test for one minute at 150% of the recommended working pressure of the hose. An exception to this would be the woven jacketed fire

hose.\* During the hydrostatic test, the hose should be straight, not coiled or in a kinked position. Water is the usual test medium and, following the test, the hose may be flushed with alcohol to remove traces of moisture. A regular schedule for testing should be followed and inspection records maintained.

**SAFETY WARNING:** Before conducting any pressure tests on hose, provisions must be made to ensure the safety of the personnel performing the tests and to prevent any possible damage to property. Only trained personnel using proper tools and procedures should conduct any pressure tests

1. Air or any other compressible gas must never be used as the test media because of the explosive action of the hose should a failure occur. Such a failure might result in possible damage to property and serious bodily injury.
2. Air should be removed from the hose by bleeding it through an outlet valve while the hose is being filled with the test medium.
3. Hose to be pressure tested must be restrained by placing steel rods or straps close to each end and at approximate 10-foot (3m) intervals along its length to keep the hose from "whipping" if failure occurs; the steel rods or straps are to be anchored firmly to the test structure but in such a manner that they do not contact the hose which must be free to move.
4. The outlet end of the hose is to be bulwarked so that a blown-out fitting will be stopped.

**Air & Multipurpose**  
General Purpose  
Heavy Duty  
Push-on

**Chemical Transfer**

**Cleaning Equipment**

**Food**  
Transfer  
Washdown

**Marine**

**Material Handling**  
Abrasives  
Bulk Transfer  
Cement & Concrete

**Mining**

**Petroleum**  
Aircraft Fueling  
Dispensing  
Dock  
Transfer

**Spray**

**Steam**

**Vacuum**

**LPG Delivery**

**Water**  
Discharge  
Suction & Discharge  
Washdown

**Welding**

**Coupling Systems**

**Equipment**

**Appendix**

# General Information

## Care, Maintenance and Storage (continued)

5. Provisions must be made to protect testing personnel from the forces of the pressure media if a failure occurs.
6. Testing personnel must never stand in front of or in back of the ends of a hose being pressure tested.
7. When liquids such as gasoline, oil, solvent or other hazardous fluids are used as the test fluid, precautions must be taken to protect against fire or other damage should a hose fail and the test liquid be sprayed over the surrounding area.

The Rubber Manufacturers Association (RMA) has published separately a series of Hose Technical Information bulletins describing Maintenance, Testing and Inspection recommendations. Reference should be made to the current RMA Catalog of Publications to determine the availability of the latest edition. Bulletins published as of January 2003 include the following:

### Publication No.

- IP 11-1- Steam Hose
- IP 11-2- Anhydrous Ammonia Hose
- IP 11-4- Oil Suction and Discharge Hose
- IP 11-5- Welding Hose
- IP 11-7- Chemical Hose
- IP 11-8- Fuel Dispensing Hose

### Storage

Rubber hose products in storage can be affected adversely by temperature, humidity, ozone, sunlight, oils, solvents, corrosive liquids and fumes, insects, rodents and radioactive materials.

The appropriate method for storing hose depends to a great extent on its size (diameter and length), the quantity to be stored and the way in which it is packaged. Hose should not be piled or stacked to such an extent that the weight of the stack creates distortions on the lengths stored at the bottom. Since hose products vary considerably in size, weight and length, it is not practical to establish definite recommendations on this point. Hose having a very light wall will not support as much load as could a hose having a heavier wall or hose having a wire reinforcement. Hose which is shipped in coils or bales should be stored so that

the coils are in a horizontal plane.

Whenever feasible, rubber hose products should be stored in their original shipping containers, especially when such containers are wooden crates or cardboard cartons which provide some protection against the deteriorating effects of oils, solvents and corrosive liquids; shipping containers also afford some protection against ozone and sunlight. Certain rodents and insects will damage rubber hose products, and adequate protection from them should be provided.

Cotton-jacketed hose should be protected against fungal growths if the hose is to be stored for prolonged periods in humidity conditions in excess of 70%.

The ideal temperature for the storage of rubber products ranges from 50°F to 70°F (10°C to 21°C) with a maximum limit of 100°F (38°C). If stored below 32°F (0°C), some rubber products become stiff and would require warming before being placed in service. Rubber products should not be stored near sources of heat, such as radiators, base heaters, etc., nor should they be stored under conditions of high or low humidity.

To avoid the adverse effects of high ozone concentration, rubber hose products should not be stored near electrical equipment that may generate ozone or be stored for any lengthy period in geographical areas of known high ozone concentration. Exposure to direct or reflected sunlight, even through windows, should also be avoided. Uncovered hose should not be stored under fluorescent or mercury lamps which generate light waves harmful to rubber.

Storage areas should be relatively cool and dark, and free of dampness and mildew. Items should be stored on a first-in, first-out basis, since even under the best of conditions, an unusually long shelf life could deteriorate certain rubber products.

\*Woven jacket fire hose should be tested in accordance with the service test provisions contained in the current edition of National Fire Protection Association Bulletin No. 1962 - Standard for the Care, Use and Service Testing of Fire Hose.

### Air & Multipurpose

General Purpose  
Heavy Duty  
Push-on

### Chemical Transfer

### Cleaning Equipment

Food  
Transfer  
Washdown

Marine

### Material Handling

Abrasives  
Bulk Transfer  
Cement & Concrete

Mining

### Petroleum

Aircraft Fueling  
Dispensing  
Dock  
Transfer

Spray

Steam

Vacuum

LPG Delivery

### Water

Discharge  
Suction & Discharge  
Washdown

Welding

Coupling Systems

Equipment

Appendix

# ContiTech



## Contact

ContiTech AG  
NAFTA Headquarters  
703 S. Cleveland Massillon Road  
Fairlawn, OH 44333-3023 U.S.A.  
1-800-235-4632

## Canada

1-888-275-4397  
FAX 1-888-464-4397

## Mexico

1-800-439-7373  
FAX 1-800-062-0918

## Germany

+49 (0)511 938 02  
mailservice@contitech.de

[www.contitech.us](http://www.contitech.us)

## ContiTech. Engineering Next Level

As a division of the Continental Group, ContiTech is a recognized innovation and technology leader in natural rubber and plastics. As an industry partner with a firm future ahead of us, we engineer solutions both with and for our customers around the world.

Our bespoke solutions are specially tailored to meet the needs of the market. With extensive expertise in materials and processes, we are able to develop cutting-edge technologies while ensuring we make responsible use of resources. We are quick to respond to important technological trends, such as function integration, lightweight engineering and the reduction of complexity, and offer a range of relevant products and services. That way, when you need us, you'll find we're already there.