



Kuriyama-Couplings™

Couplings & Accessories



Kuriyama of America, Inc.



EDITION 1013



Index

Clamps:

Center Punch	42-43
Double Bolt	45
Ducting-Bridge.....	45
Interlocking Bolt.....	48
Spiral Double Bolt	44
T-Bolt.....	46-47
Combination Hose Nipples	34-35
Crimp Sleeves.....	49
Expansion Joints – Rubber.....	62-65
Flanges – Forged Plate Style.....	56-58
Flanges – Forged Raised Face	59-61
Gaskets	66-68
Ground Joint Couplings	38-39
Hammer Unions	28-30
Handles	69
Hose and Tubing Cutters.....	55
Hose Menders	55
Hose Safety Cables.....	55
Hydrant & Garden Hose.....	50-51
Pin Lug – Hose Shank Couplings.....	36
Pin Lug – Leak Resistant Couplings	16
Push-On Fittings – Brass	52-53

Quick-Acting Couplings:

ALSH Aluminum.....	17
Aluminum	4-5

Quick-Acting Couplings continued:

Aluminum Compression	24
Brass.....	6-7
Ductile Iron	17
Glass Reinforced Nylon.....	14-15
K-Loc™ Auto Lock SS316	24
Leak Resistant	16
Petroleum	22
Polypropylene	12-13
Special Application.....	20-21
Specifications	25-27
SS304 Stainless Steel.....	10-11
SS316 Stainless Steel.....	8-9
Swivel.....	23
Weld	18-19
Quick Disconnect Couplings.....	54
Safety Clips	70
Sandblast Couplings	40
Sight Glasses.....	32
Strainers.....	32-33
Universal Air Hose Couplings.....	41
Valves.....	31
Chemical Resistance Chart	71-75
Cautionary Statement & Limited Warranty.....	76

Because we continually examine ways to improve our products, we reserve the right to alter specifications or discontinue products without prior notice.



Couplings and Accessories Index by Series Number

Series	Page
AB	36
ABF	36
ABF-LF	16
ABM	36
ABM-LF	16
AHG	68
AL-A	4
AL-B	4
AL-B	20
AL-C	4
AL-C	20
AL-CLF	16
AL-D	4
AL-DC	5
AL-DP	5
AL-E	5
AL-E	20
AL-ELF	16
AL-F	5
AL-F	20
ALSH-B	17
ALSH-C	17
ALSH-D	17
ALSH-DC	17
APS	32
BB	36
BC2	48
BC4	48
BC6	48
BCAL	24
BCAP	50
BE	41
BHN	51
BHS	33
BHYA	50
BR-A	6
BR-B	6
BR-C	6
BR-D	6
BR-DC	7
BR-DP	7
BR-E	7
BR-F	7
BRGHT	51
BRGHT-FEM	51
BRNPS	51
BRNPS-FEM	51
BUNA	66
BW-ALB	18
BW-ALF	18
BW-SSB	18

Series	Page
BW-SSF	18
CGDP-A	22
CPA	42
CPCS	43
CPSS	43
CPT	42
CRS-AL	49
CRS-CS	49
CRS-SS	49
CSPF	56
CSRF1500	59
CSRF3000	59
CSRFTHD	60
DA90-A	20
DAP	22
DB	45
DCLPL	45
DCLPR	45
DD-AL	20
DD-SS	21
DI-C	17
DI-E	17
DMHN	50
EPDM	66
FCAL	24
FE	41
FHE	41
FHNST	36
FHNST-F	36
FHNST-M	36
FHW	68
FL-AL-A	20
FL-AL-D	20
FMHN	50
FNS	32
FV	31
GDS	39
GEN	34
GJ	38
GJF	38
GJM	39
GJN	38
GJS	38
GMS	39
GRA	14
GRB	14
GRC	14
GRD	14
GRDC	15
GRDP	15
GRE	15

Series	Page
GRF	15
GRN	35
HA BRASS	69
HA POLY	69
HA ST-STL	69
HC	48
HE	41
HEX-SPN	34
HEX-STN	34
HTDRF	63
HTDRU	63
HTSRF	62
HUB206	30
HUS	66
HUT100	28
HUT1002	28
HUT1502	29
HUT200	28
HUT206	28
HUT400	28
HUT602	28
HUW1002	29
HUW1502	29
HUW602	29
HW	68
K-LOCSSHA	69
KAS-C	23
KAS-E	23
KLOC-SS-B	24
KLOC-SS-C	24
KLOC-SS-D	24
KLOC-SS-DC	24
KSS-E	23
KURI-CUTTER	55
LHS	33
ME	41
NBR-LF	67
NH-AL	40
NH-BR	40
POFFIV	53
POFFJS	53
POFFP	52
POFFPS	52
POFFSA	53
POFMD	52
POFMIV	53
POFMJS	53
POFMMP	52
POFMPE	52
POFMPS	52
POFMSA	53

Series	Page
PPA	12
PPA90	21
PPB	12
PPBV	31
PPC	12
PPC90	21
PPD	12
PPD90	21
PPDC	13
PPDP	13
PPE	13
PPF	13
PPF90	21
PPN	35
PPS	33
Q-AL	40
Q-BR	40
Q-PI	40
QDACFC	54
QDACMC	54
QDAPFP	54
QDAPHC	54
QDAPHP	54
QDAPMP	54
RDA-A	20
RDA-B	21
RDA-SS	21
RHS	33
SA-A	20
SA-B	21
SA-SS	21
SB-AL	40
SB-BR	40
SBG	68
SCAL-C	23
SCAL-E	23
SCSS	70
SDBC	44
SDBC-SS	44
SDBCR	44
SG	32
SHS	33
SPHM	55
SPN	34
SRG	68
SS-A	8
SS-B	8
SS-C	8
SS-D	8
SS-DC	9
SS-DP	9

Series	Page
SS-E	9
SS-F	9
SS304-A	10
SS304-B	10
SS304-C	10
SS304-D	10
SS304-DC	11
SS304-DP	11
SS304-E	11
SS304-F	11
SSN	35
SSN304	35
SSPF304	57
SSPF316	58
SSRF304	61
STN	34
SW	51
SW-ALA	19
SW-ALD	19
SW-SSA	19
SW-SSD	19
SWHA	51
SWLA	51
SWU	51
TBC-SS	46
TBC-SSC	47
TCC-A	22
TCDA-A	22
TCDC-A	22
TCDD-A	22
TCG	67
THS	33
TWC	41
USCL	70
VITON	66
VRP-A	22
VRP-P	22
VRP-PROBE	22
WC	55
WN	67
WNIT	23
WS	55

Because we continually examine ways to improve our products, we reserve the right to alter specifications or discontinue products without prior notice.



Aluminum Quick-Acting Couplings



Aluminum Part A Male Adapter x Female NPT

Part Number	Size (in.)	Weight Each (lbs.)	Standard Carton
AL-A050	1/2 x 1/2	0.10	100
AL-A075	3/4	0.13	50
AL-A100	1	0.12	70
AL-A125	1 1/4	0.20	40
AL-A150	1 1/2	0.28	30
AL-A200	2	0.38	40
AL-A250	2 1/2	0.58	50
AL-A300	3	0.70	35
AL-A400	4	1.58	20
AL-A500	5	1.74	4
AL-A600	6	2.95	15
AL-A800	8	7.58	2
AL-A1000	10	9.88	2
HDAL-A801	8	9.48	2



Aluminum Part B Female Coupler x Male NPT

Part Number	Size (in.)	Weight Each (lbs.)	Standard Carton
AL-B050	1/2 x 1/2	0.18	100
AL-B075	3/4	0.24	50
AL-B100	1	0.36	30
AL-B125	1 1/4	0.62	45
AL-B150	1 1/2	0.70	30
AL-B200	2	0.86	50
AL-B250	2 1/2	1.02	40
AL-B300	3	1.56	25
AL-B400	4	2.42	25
AL-B500	5	3.34	4
AL-B600	6	4.98	10
AL-B800	8	8.03	2
AL-B1000	10	12.13	2
HDAL-B801	8	10.54	2

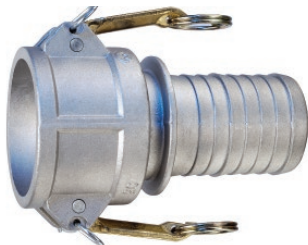

Aluminum Part C Female Coupler x Hose Shank

Part Number	Size (in.)	Weight Each (lbs.)	Standard Carton
AL-C050	1/2 x 1/2	0.20	100
AL-C075	3/4	0.26	50
AL-C100	1	0.42	60
AL-C125	1 1/4	0.68	35
AL-C150	1 1/2	0.74	30
AL-C200	2	0.98	40
AL-C250	2 1/2	1.28	30
AL-C300	3	2.20	15
AL-C400	4	3.16	15
AL-C500	5	3.88	4
AL-C600	6	7.70	6
AL-C800	8	10.63	1
AL-C1000	10	16.67	1
HDAL-C801	8	12.58	1



Aluminum Part D Female Coupler x Female NPT

Part Number	Size (in.)	Weight Each (lbs.)	Standard Carton
AL-D050	1/2 x 1/2	0.18	100
AL-D075	3/4	0.22	50
AL-D100	1	0.42	30
AL-D125	1 1/4	0.68	40
AL-D150	1 1/2	0.80	30
AL-D200	2	0.92	40
AL-D250	2 1/2	1.18	35
AL-D300	3	1.80	20
AL-D400	4	2.16	10
AL-D500	5	3.42	4
AL-D600	6	4.24	10
AL-D800	8	9.50	2
AL-D1000	10	12.52	2
HDAL-D801	8	11.77	2

See applications and specifications on page 25.

Because we continually examine ways to improve our products, we reserve the right to alter specifications or discontinue products without prior notice.

Aluminum Quick-Acting Couplings



Aluminum Part E Male Adapter x Hose Shank

Part Number	Size (in.)	Weight Each (lbs.)	Standard Carton
AL-E050	1/2 x 1/2	0.08	100
AL-E075	3/4	0.11	50
AL-E100	1	0.20	50
AL-E125	1 1/4	0.26	30
AL-E150	1 1/2	0.38	40
AL-E200	2	0.60	50
AL-E250	2 1/2	0.86	20
AL-E300	3	1.32	18
AL-E400	4	2.10	20
AL-E500	5	3.56	4
AL-E600	6	6.16	6
AL-E800	8	7.73	2
AL-E1000	10	12.90	1
HDAL-E801	8	9.75	2



Aluminum Part F Male Adapter x Male NPT

Part Number	Size (in.)	Weight Each (lbs.)	Standard Carton
AL-F050	1/2 x 1/2	0.14	100
AL-F075	3/4	0.16	50
AL-F100	1	0.20	45
AL-F125	1 1/4	0.34	30
AL-F150	1 1/2	0.46	50
AL-F200	2	0.68	60
AL-F250	2 1/2	0.96	30
AL-F300	3	1.30	20
AL-F400	4	2.32	25
AL-F500	5	2.94	4
AL-F600	6	3.92	10
AL-F800	8	7.94	2
AL-F1000	10	10.58	2
HDAL-F801	8	9.95	2



Aluminum Part DC Dust Cap

Part Number	Size (in.)	Weight Each (lbs.)	Standard Carton
AL-DC050	1/2	0.18	100
AL-DC075	3/4	0.22	50
AL-DC100	1	0.34	40
AL-DC125	1 1/4	0.58	25
AL-DC150	1 1/2	0.64	40
AL-DC200	2	0.80	60
AL-DC250	2 1/2	0.94	50
AL-DC300	3	1.44	30
AL-DC400	4	2.34	15
AL-DC500	5	3.06	4
AL-DC600	6	4.66	6
AL-DC800	8	9.04	4
AL-DC1000	10	12.54	3
HDAL-DC801	8	10.63	4



Aluminum Part DP Dust Plug

Part Number	Size (in.)	Weight Each (lbs.)	Standard Carton
AL-DP050	1/2	0.07	100
AL-DP075	3/4	0.08	50
AL-DP100	1	0.10	80
AL-DP125	1 1/4	0.18	50
AL-DP150	1 1/2	0.25	50
AL-DP200	2	0.38	60
AL-DP250	2 1/2	0.54	40
AL-DP300	3	0.74	50
AL-DP400	4	1.22	25
AL-DP500	5	1.46	4
AL-DP600	6	2.53	20
AL-DP800	8	4.04	6
AL-DP1000	10	5.36	4
HDAL-DP801	8	5.00	6

See applications and specifications on page 25.

Because we continually examine ways to improve our products, we reserve the right to alter specifications or discontinue products without prior notice.



Brass Quick-Acting Couplings



Brass Part A Male Adapter x Female NPT

Part Number	Size (in.)	Weight Each (lbs.)	Standard Carton
BR-A050	1/2 x 1/2	0.15	50
BR-A075	3/4	0.24	25
BR-A100	1	0.34	25
BR-A125	1 1/4	0.66	36
BR-A150	1 1/2	0.73	25
BR-A200	2	0.86	20
BR-A250	2 1/2	1.61	12
BR-A300	3	1.72	8
BR-A400	4	3.41	6
BR-A500	5	4.85	4
BR-A600	6	7.27	2



Brass Part B Female Coupler x Male NPT

Part Number	Size (in.)	Weight Each (lbs.)	Standard Carton
BR-B050	1/2 x 1/2	0.36	50
BR-B075	3/4	0.44	25
BR-B100	1	0.66	25
BR-B125	1 1/4	1.19	20
BR-B150	1 1/2	1.21	20
BR-B200	2	1.39	20
BR-B250	2 1/2	1.87	12
BR-B300	3	3.36	8
BR-B400	4	4.19	6
BR-B500	5	5.18	4
BR-B600	6	8.25	2



Brass Part C Female Coupler x Hose Shank

Part Number	Size (in.)	Weight Each (lbs.)	Standard Carton
BR-C050	1/2 x 1/2	0.35	50
BR-C075	3/4	0.53	25
BR-C100	1	0.81	25
BR-C125	1 1/4	1.23	20
BR-C150	1 1/2	1.32	20
BR-C200	2	1.72	20
BR-C250	2 1/2	2.42	12
BR-C300	3	3.74	8
BR-C400	4	5.51	6
BR-C500	5	7.27	4
BR-C600	6	13.77	2



Brass Part D Female Coupler x Female NPT

Part Number	Size (in.)	Weight Each (lbs.)	Standard Carton
BR-D050	1/2 x 1/2	0.35	50
BR-D075	3/4	0.51	25
BR-D100	1	0.75	25
BR-D125	1 1/4	1.12	20
BR-D150	1 1/2	1.21	25
BR-D200	2	1.43	25
BR-D250	2 1/2	1.87	12
BR-D300	3	3.13	8
BR-D400	4	5.29	6
BR-D500	5	5.62	4
BR-D600	6	10.95	2

See applications and specifications on page 25.

Because we continually examine ways to improve our products, we reserve the right to alter specifications or discontinue products without prior notice.



Brass Quick-Acting Couplings

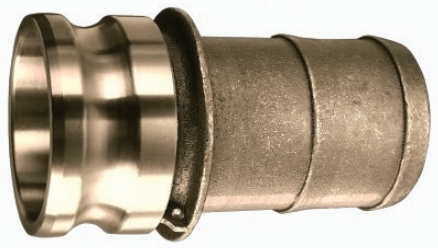

Brass Part E Male Adapter x Hose Shank

Part Number	Size (in.)	Weight Each (lbs.)	Standard Carton
BR-E050	1/2 x 1/2	0.24	50
BR-E075	3/4	0.36	25
BR-E100	1	0.59	25
BR-E125	1 1/4	0.75	25
BR-E150	1 1/2	1.01	25
BR-E200	2	1.54	20
BR-E250	2 1/2	2.11	12
BR-E300	3	3.08	8
BR-E400	4	4.30	6
BR-E500	5	7.60	4
BR-E600	6	12.33	2

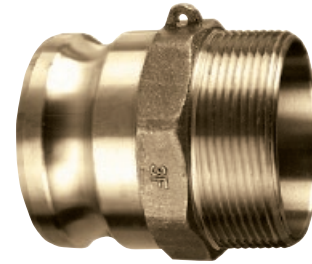

Brass Part F Male Adapter x Male NPT

Part Number	Size (in.)	Weight Each (lbs.)	Standard Carton
BR-F050	1/2 x 1/2	0.22	50
BR-F075	3/4	0.33	25
BR-F100	1	0.53	25
BR-F125	1 1/4	0.66	25
BR-F150	1 1/2	0.88	25
BR-F200	2	1.08	20
BR-F250	2 1/2	1.85	12
BR-F300	3	2.42	8
BR-F400	4	3.74	6
BR-F500	5	4.63	4
BR-F600	6	9.03	2

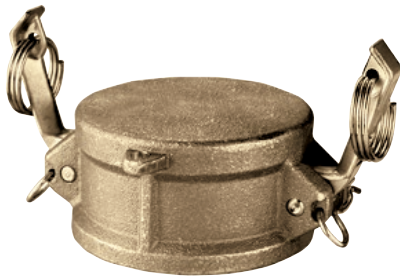

Brass Part DC Dust Cap

Part Number	Size (in.)	Weight Each (lbs.)	Standard Carton
BR-DC075	3/4	0.66	50
BR-DC100	1	0.95	25
BR-DC125	1 1/4	1.04	20
BR-DC150	1 1/2	1.32	25
BR-DC200	2	2.05	20
BR-DC250	2 1/2	2.20	12
BR-DC300	3	3.96	8
BR-DC400	4	4.74	6
BR-DC500	5	8.59	4
BR-DC600	6	4.66	2



Brass Part DP Dust Plug

Part Number	Size (in.)	Weight Each (lbs.)	Standard Carton
BR-DP075	3/4	0.22	50
BR-DP100	1	0.33	25
BR-DP125	1 1/4	0.46	25
BR-DP150	1 1/2	0.53	25
BR-DP200	2	0.99	20
BR-DP250	2 1/2	1.20	12
BR-DP300	3	1.65	8
BR-DP400	4	2.42	6
BR-DP500	5	3.74	4
BR-DP600	6	4.74	2

See applications and specifications on page 25.

Because we continually examine ways to improve our products, we reserve the right to alter specifications or discontinue products without prior notice.



SS316 Stainless Steel Quick-Acting Couplings



316 Stainless Part A Male Adapter x Female NPT

Part Number	Size (in.)	Weight Each (lbs.)	Standard Carton
SS-A050	1/2 x 1/2	0.20	50
SS-A075	3/4	0.26	25
SS-A100	1	0.34	25
SS-A125	1 1/4	0.62	36
SS-A150	1 1/2	0.80	25
SS-A200	2	1.12	20
SS-A250	2 1/2	1.76	12
SS-A300	3	2.16	8
SS-A400	4	2.88	6
SS-A500	5	4.30	4
SS-A600	6	6.00	2



316 Stainless Part B Female Coupler x Male NPT

Part Number	Size (in.)	Weight Each (lbs.)	Standard Carton
SS-B050	1/2 x 1/2	0.30	50
SS-B075	3/4	0.42	25
SS-B100	1	0.64	25
SS-B125	1 1/4	1.32	20
SS-B150	1 1/2	1.50	20
SS-B200	2	1.92	20
SS-B250	2 1/2	2.68	12
SS-B300	3	3.20	8
SS-B400	4	6.58	6
SS-B500	5	6.80	4
SS-B600	6	10.98	2



316 Stainless Part C Female Coupler x Hose Shank

Part Number	Size (in.)	Weight Each (lbs.)	Standard Carton
SS-C050	1/2 x 1/2	0.30	50
SS-C075	3/4	0.46	25
SS-C100	1	0.74	25
SS-C125	1 1/4	1.41	20
SS-C150	1 1/2	1.68	20
SS-C200	2	2.30	20
SS-C250	2 1/2	3.10	12
SS-C300	3	4.12	8
SS-C400	4	6.98	6
SS-C500	5	10.32	4
SS-C600	6	14.55	2



316 Stainless Part D Female Coupler x Female NPT

Part Number	Size (in.)	Weight Each (lbs.)	Standard Carton
SS-D050	1/2 x 1/2	0.40	50
SS-D075	3/4	0.52	25
SS-D100	1	0.74	25
SS-D125	1 1/4	1.47	20
SS-D150	1 1/2	1.52	25
SS-D200	2	2.16	25
SS-D250	2 1/2	3.12	12
SS-D300	3	3.82	8
SS-D400	4	5.14	6
SS-D500	5	8.00	4
SS-D600	6	10.06	2

See applications and specifications on page 26.

Because we continually examine ways to improve our products, we reserve the right to alter specifications or discontinue products without prior notice.



SS316 Stainless Steel Quick-Acting Couplings



316 Stainless Part E Male Adapter x Hose Shank

Part Number	Size (in.)	Weight Each (lbs.)	Standard Carton
SS-E050	1/2 x 1/2	0.25	50
SS-E075	3/4	0.36	25
SS-E100	1	0.60	25
SS-E125	1 1/4	0.95	25
SS-E150	1 1/2	1.22	25
SS-E200	2	1.98	20
SS-E250	2 1/2	2.64	12
SS-E300	3	3.90	8
SS-E400	4	6.38	6
SS-E500	5	9.10	4
SS-E600	6	13.49	2

316 Stainless Part F Male Adapter x Male NPT

Part Number	Size (in.)	Weight Each (lbs.)	Standard Carton
SS-F050	1/2 x 1/2	0.30	50
SS-F075	3/4	0.40	25
SS-F100	1	0.56	25
SS-F125	1 1/4	1.06	25
SS-F150	1 1/2	1.28	25
SS-F200	2	1.82	20
SS-F250	2 1/2	2.68	12
SS-F300	3	3.92	8
SS-F400	4	6.32	6
SS-F500	5	8.26	4
SS-F600	6	11.27	2



316 Stainless Part DC Dust Cap

Part Number	Size (in.)	Weight Each (lbs.)	Standard Carton
SS-DC050	1/2	0.25	50
SS-DC075	3/4	0.36	25
SS-DC100	1	0.54	25
SS-DC125	1 1/4	1.30	20
SS-DC150	1 1/2	1.46	25
SS-DC200	2	1.78	20
SS-DC250	2 1/2	2.38	12
SS-DC300	3	3.04	8
SS-DC400	4	5.02	6
SS-DC500	5	7.35	4
SS-DC600	6	9.92	2

316 Stainless Part DP Dust Plug

Part Number	Size (in.)	Weight Each (lbs.)	Standard Carton
SS-DP050	1/2	0.15	50
SS-DP075	3/4	0.20	25
SS-DP100	1	0.28	25
SS-DP125	1 1/4	0.60	25
SS-DP150	1 1/2	0.72	25
SS-DP200	2	0.96	20
SS-DP250	2 1/2	1.47	12
SS-DP300	3	1.94	8
SS-DP400	4	3.36	6
SS-DP500	5	6.24	4
SS-DP600	6	9.08	2

See applications and specifications on page 26.

Because we continually examine ways to improve our products, we reserve the right to alter specifications or discontinue products without prior notice.



SS304 Stainless Steel Quick-Acting Couplings



304 Stainless Part A Male Adapter x Female NPT

Part Number	Size (in.)	Weight Each (lbs.)	Standard Carton
SS304-A050	1/2 x 1/2	0.20	50
SS304-A075	3/4	0.26	25
SS304-A100	1	0.34	25
SS304-A125	1 1/4	0.62	36
SS304-A150	1 1/2	0.80	25
SS304-A200	2	1.12	20
SS304-A250	2 1/2	1.76	12
SS304-A300	3	2.16	8
SS304-A400	4	2.88	6
SS304-A500	5	4.30	4
SS304-A600	6	6.00	2



304 Stainless Part B Female Coupler x Male NPT

Part Number	Size (in.)	Weight Each (lbs.)	Standard Carton
SS304-B050	1/2 x 1/2	0.30	50
SS304-B075	3/4	0.42	25
SS304-B100	1	0.64	25
SS304-B125	1 1/4	1.32	20
SS304-B150	1 1/2	1.50	20
SS304-B200	2	1.92	20
SS304-B250	2 1/2	2.68	12
SS304-B300	3	3.20	8
SS304-B400	4	6.58	6
SS304-B500	5	6.80	4
SS304-B600	6	10.98	2



304 Stainless Part C Female Coupler x Hose Shank

Part Number	Size (in.)	Weight Each (lbs.)	Standard Carton
SS304-C050	1/2 x 1/2	0.30	50
SS304-C075	3/4	0.46	25
SS304-C100	1	0.74	25
SS304-C125	1 1/4	1.41	20
SS304-C150	1 1/2	1.68	20
SS304-C200	2	2.30	20
SS304-C250	2 1/2	3.10	12
SS304-C300	3	4.12	8
SS304-C400	4	6.98	6
SS304-C500	5	10.32	4
SS304-C600	6	14.55	2



304 Stainless Part D Female Coupler x Female NPT

Part Number	Size (in.)	Weight Each (lbs.)	Standard Carton
SS304-D050	1/2 x 1/2	0.40	50
SS304-D075	3/4	0.52	25
SS304-D100	1	0.74	25
SS304-D125	1 1/4	1.47	20
SS304-D150	1 1/2	1.52	25
SS304-D200	2	2.16	25
SS304-D250	2 1/2	3.12	12
SS304-D300	3	3.82	8
SS304-D400	4	5.14	6
SS304-D500	5	8.00	4
SS304-D600	6	10.06	2

See applications and specifications on page 26.

Because we continually examine ways to improve our products, we reserve the right to alter specifications or discontinue products without prior notice.



SS304 Stainless Steel Quick-Acting Couplings



304 Stainless Part E Male Adapter x Hose Shank

Part Number	Size (in.)	Weight Each (lbs.)	Standard Carton
SS304-E050	1/2 x 1/2	0.25	50
SS304-E075	3/4	0.36	25
SS304-E100	1	0.60	25
SS304-E125	1 1/4	0.95	25
SS304-E150	1 1/2	1.22	25
SS304-E200	2	1.98	20
SS304-E250	2 1/2	2.64	12
SS304-E300	3	3.90	8
SS304-E400	4	6.38	6
SS304-E500	5	9.10	4
SS304-E600	6	13.49	2

304 Stainless Part F Male Adapter x Male NPT

Part Number	Size (in.)	Weight Each (lbs.)	Standard Carton
SS304-F050	1/2 x 1/2	0.30	50
SS304-F075	3/4	0.40	25
SS304-F100	1	0.56	25
SS304-F125	1 1/4	1.06	25
SS304-F150	1 1/2	1.28	25
SS304-F200	2	1.82	20
SS304-F250	2 1/2	2.68	12
SS304-F300	3	3.92	8
SS304-F400	4	6.32	6
SS304-F500	5	8.26	4
SS304-F600	6	11.27	2



304 Stainless Part DC Dust Cap

Part Number	Size (in.)	Weight Each (lbs.)	Standard Carton
SS304-DC050	1/2	0.25	50
SS304-DC075	3/4	0.36	25
SS304-DC100	1	0.54	25
SS304-DC125	1 1/4	1.30	20
SS304-DC150	1 1/2	1.46	25
SS304-DC200	2	1.78	20
SS304-DC250	2 1/2	2.38	12
SS304-DC300	3	3.04	8
SS304-DC400	4	5.02	6
SS304-DC500	5	7.35	4
SS304-DC600	6	9.92	2

304 Stainless Part DP Dust Plug

Part Number	Size (in.)	Weight Each (lbs.)	Standard Carton
SS304-DP050	1/2	0.15	50
SS304-DP075	3/4	0.20	25
SS304-DP100	1	0.28	25
SS304-DP125	1 1/4	0.60	25
SS304-DP150	1 1/2	0.72	25
SS304-DP200	2	0.96	20
SS304-DP250	2 1/2	1.47	12
SS304-DP300	3	1.94	8
SS304-DP400	4	3.36	6
SS304-DP600	6	9.08	2

See applications and specifications on page 26.

Because we continually examine ways to improve our products, we reserve the right to alter specifications or discontinue products without prior notice.



Polypropylene Quick-Acting Couplings



Polypropylene Part A Male Adapter x Female NPT

Part Number	Size (in.)	Weight Each (lbs.)	Standard Carton
PPA050	1/2 x 1/2	0.04	200
PPA075	3/4	0.05	50
PPA100	1	0.05	70
PPA125	1 1/4	0.10	40
PPA150	1 1/2	0.14	30
PPA200	2	0.19	40
PPA300	3	0.48	35
PPA400	4	1.02	20



Polypropylene Part B Female Coupler x Male NPT

Part Number	Size (in.)	Weight Each (lbs.)	Standard Carton
PPB050	1/2 x 1/2	0.17	50
PPB075	3/4	0.18	50
PPB100	1	0.26	30
PPB125	1 1/4	0.40	45
PPB150	1 1/2	0.47	30
PPB200	2	0.49	50
PPB300	3	1.17	25
PPB400	4	1.44	25



Polypropylene Part C Female Coupler x Hose Shank

Part Number	Size (in.)	Weight Each (lbs.)	Standard Carton
PPC050	1/2 x 1/2	0.17	100
PPC075	3/4	0.19	50
PPC100	1	0.27	60
PPC125	1 1/4	0.40	35
PPC150	1 1/2	0.51	30
PPC200	2	0.61	40
PPC300	3	1.28	15
PPC400	4	1.70	15



Polypropylene Part D Female Coupler x Female NPT

Part Number	Size (in.)	Weight Each (lbs.)	Standard Carton
PPD050	1/2 x 1/2	0.18	100
PPD075	3/4	0.19	50
PPD100	1	0.25	30
PPD125	1 1/4	0.41	40
PPD150	1 1/2	0.53	30
PPD200	2	0.55	40
PPD300	3	1.17	20
PPD400	4	1.58	10

See applications and specifications on page 27.

Because we continually examine ways to improve our products, we reserve the right to alter specifications or discontinue products without prior notice.

Polypropylene Quick-Acting Couplings



Polypropylene Part E Male Adapter x Hose Shank

Part Number	Size (in.)	Weight Each (lbs.)	Standard Carton
PPE050	1/2 x 1/2	0.03	200
PPE075	3/4	0.06	50
PPE100	1	0.08	50
PPE125	1 1/4	0.15	30
PPE150	1 1/2	0.17	40
PPE200	2	0.30	50
PPE300	3	0.76	18
PPE400	4	1.00	20



Polypropylene Part F Male Adapter x Male NPT

Part Number	Size (in.)	Weight Each (lbs.)	Standard Carton
PPF050	1/2 x 1/2	0.04	200
PPF075	3/4	0.06	50
PPF100	1	0.11	45
PPF125	1 1/4	0.15	30
PPF150	1 1/2	0.18	50
PPF200	2	0.29	60
PPF300	3	0.56	20
PPF400	4	0.81	25



Polypropylene Part DC Dust Cap

Part Number	Size (in.)	Weight Each (lbs.)	Standard Carton
PPDC050	1/2	0.16	100
PPDC075	3/4	0.17	50
PPDC100	1	0.24	40
PPDC125	1 1/4	0.42	25
PPDC150	1 1/2	0.47	40
PPDC200	2	0.50	60
PPDC300	3	1.06	30
PPDC400	4	1.11	15



Polypropylene Part DP Dust Plug

Part Number	Size (in.)	Weight Each (lbs.)	Standard Carton
PPDP050	1/2	0.02	200
PPDP075	3/4	0.03	50
PPDP100	1	0.04	80
PPDP125	1 1/4	0.06	50
PPDP150	1 1/2	0.10	50
PPDP200	2	0.15	60
PPDP300	3	0.36	50
PPDP400	4	0.50	25

See applications and specifications on page 27.

Because we continually examine ways to improve our products, we reserve the right to alter specifications or discontinue products without prior notice.



Glass Reinforced Nylon Quick-Acting Couplings



Nylon Part A Male Adapter x Female NPT

Part Number	Size (in.)	Weight Each (lbs.)	Standard Carton
GRA100	1	0.16	70
GRA150	1 1/2	0.18	30
GRA200	2	0.26	40
GRA300	3	0.46	35
GRA400	4	0.92	20



Nylon Part B Female Coupler x Male NPT

Part Number	Size (in.)	Weight Each (lbs.)	Standard Carton
GRB100	1	0.16	30
GRB150	1 1/2	0.46	30
GRB200	2	0.52	50
GRB300	3	1.02	25
GRB400	4	1.34	25

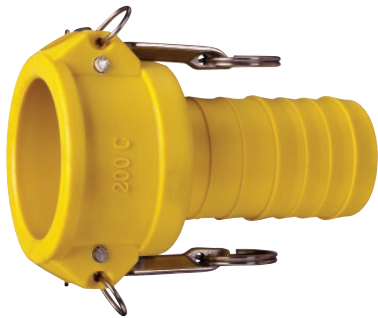

Nylon Part C Female Coupler x Hose Shank

Part Number	Size (in.)	Weight Each (lbs.)	Standard Carton
GRC100	1	0.18	60
GRC150	1 1/2	0.50	30
GRC200	2	0.58	40
GRC300	3	1.24	15
GRC400	4	1.60	15



Nylon Part D Female Coupler x Female NPT

Part Number	Size (in.)	Weight Each (lbs.)	Standard Carton
GRD100	1	0.18	30
GRD150	1 1/2	0.50	30
GRD200	2	0.58	40
GRD300	3	1.04	20
GRD400	4	1.48	10

See applications and specifications on page 27.

Because we continually examine ways to improve our products, we reserve the right to alter specifications or discontinue products without prior notice.



Glass Reinforced Nylon Quick-Acting Couplings



Nylon Part E Male Adapter x Hose Shank

Part Number	Size (in.)	Weight Each (lbs.)	Standard Carton
GRE100	1	0.16	50
GRE150	1 1/2	0.18	40
GRE200	2	0.28	50
GRE300	3	0.66	18
GRE400	4	1.04	20



Nylon Part F Male Coupler x Male NPT

Part Number	Size (in.)	Weight Each (lbs.)	Standard Carton
GRF100	1	0.10	45
GRF150	1 1/2	0.18	50
GRF200	2	0.28	60
GRF300	3	0.66	20
GRF400	4	0.90	25



Nylon Part DC Dust Cap

Part Number	Size (in.)	Weight Each (lbs.)	Standard Carton
GRDC100	1	0.16	40
GRDC150	1 1/2	0.46	40
GRDC200	2	0.50	60
GRDC300	3	0.96	30
GRDC400	4	1.16	15



Nylon Part DP Dust Plug

Part Number	Size (in.)	Weight Each (lbs.)	Standard Carton
GRDP100	1	0.06	50
GRDP150	1 1/2	0.12	50
GRDP200	2	0.20	60
GRDP300	3	0.36	50
GRDP400	4	0.60	25

See applications and specifications on page 27.

Because we continually examine ways to improve our products, we reserve the right to alter specifications or discontinue products without prior notice.



EZ-Seal™ Leak Resistant Couplings Ideally Suited for Layflat Hoses

Applications:

- Agriculture • Chemicals • Petroleum • Construction
- Material handling

Construction:

- Aluminum; ASTM B85 Grade 383

Features & Benefits:

- Rubber seals - Help prevent leakage
- Interchangeability - Part C & E conform to Mil Spec A-A-59326
- Versatile - Suitable for use with other PVC and Rubber Hoses

Note: To insure proper sealing attach band clamps directly over rubber seals.



Aluminum Part C Female Coupler x Hose Shank

Part Number	Size (in.)	Weight Each (lbs.)	Standard Carton
AL-CLF150	1 1/2	0.77	30
AL-CLF200	2	0.98	40
AL-CLF300	3	1.98	15
AL-CLF400	4	2.87	15



Aluminum Part E Male Adapter x Hose Shank

Part Number	Size (in.)	Weight Each (lbs.)	Standard Carton
AL-ELF150	1 1/2	0.44	40
AL-ELF200	2	0.64	50
AL-ELF300	3	1.38	18
AL-ELF400	4	2.51	20



Aluminum Pin Lug Hose Shank with Brass Swivel Nut Female End (NPSM Threads)

Part Number	Size (in.)	Weight Each (lbs.)	Standard Carton
ABF-LF150	1 1/2	0.37	150
ABF-LF200	2	0.58	80
ABF-LF300	3	1.16	24
ABF-LF400	4	2.01	20



Aluminum Pin Lug Hose Shank Male End (NPSM Threads)

Part Number	Size (in.)	Weight Each (lbs.)	Standard Carton
ABM-LF150	1 1/2	0.22	150
ABM-LF200	2	0.40	80
ABM-LF300	3	1.04	24
ABM-LF400	4	1.48	20

See applications and specifications on pages 25 & 36.

Because we continually examine ways to improve our products, we reserve the right to alter specifications or discontinue products without prior notice.

Ductile Iron Quick-Acting Couplings “Maximum Flow Design”



Ductile Iron Part C Female Coupler x Hose Shank

Part Number	Size (in.)	Weight Each (lbs.)	Standard Carton
DI-C400	4	7.29	15



Ductile Iron Part E Male Adapter x Hose Shank

Part Number	Size (in.)	Weight Each (lbs.)	Standard Carton
DI-E400	4	5.84	20

ALSH Aluminum Quick-Acting Couplings Supplied with Stainless Steel Handles, Slot Pins, Safety Clips & Pull Rings



Aluminum Part B Female Coupler x Male NPT

Part Number	Size (in.)	Weight Each (lbs.)	Standard Carton
ALSH-B100	1	0.36	25
ALSH-B125	1 1/4	0.62	20
ALSH-B150	1 1/2	0.70	12
ALSH-B200	2	0.86	10
ALSH-B250	2 1/2	1.02	12
ALSH-B300	3	1.56	8
ALSH-B400	4	2.42	12



Aluminum Part D Female Coupler x Female NPT

Part Number	Size (in.)	Weight Each (lbs.)	Standard Carton
ALSH-D100	1	0.42	25
ALSH-D125	1 1/4	0.68	20
ALSH-D150	1 1/2	0.80	12
ALSH-D200	2	0.92	10
ALSH-D250	2 1/2	1.18	12
ALSH-D300	3	1.80	10
ALSH-D400	4	2.82	10

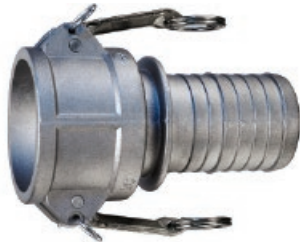

Aluminum Part C Female Coupler x Hose Shank

Part Number	Size (in.)	Weight Each (lbs.)	Standard Carton
ALSH-C100	1	0.42	25
ALSH-C125	1 1/4	0.68	20
ALSH-C150	1 1/2	0.74	10
ALSH-C200	2	0.98	12
ALSH-C250	2 1/2	1.28	12
ALSH-C300	3	2.20	5
ALSH-C400	4	3.16	6



Aluminum Part DC Dust Cap

Part Number	Size (in.)	Weight Each (lbs.)	Standard Carton
ALSH-DC100	1	0.34	25
ALSH-DC125	1 1/4	0.58	20
ALSH-DC150	1 1/2	0.64	25
ALSH-DC200	2	0.80	20
ALSH-DC250	2 1/2	0.94	12
ALSH-DC300	3	1.44	8
ALSH-DC400	4	2.34	6

See applications and specifications on pages 25 & 27.

Because we continually examine ways to improve our products, we reserve the right to alter specifications or discontinue products without prior notice.



Quick-Acting Weld Couplings

BW Items are Dual Purpose

Butt Weld to Schedule 40 Pipe or Socket Weld to Nominal OD Tubing



Aluminum Part F Male Adapter

Part Number	Size (in.)	Weight Each (lbs.)	Standard Carton
BW-ALF150	1 1/2	0.52	50
BW-ALF200	2	0.74	60
BW-ALF250	2 1/2	1.02	30
BW-ALF300	3	1.36	20
BW-ALF400	4	2.40	25
BW-ALF500	5	3.03	4
BW-ALF600	6	4.01	10
BW-ALF800	8	8.05	2



Aluminum Part B Female Coupler

Part Number	Size (in.)	Weight Each (lbs.)	Standard Carton
BW-ALB150	1 1/2	0.76	30
BW-ALB200	2	0.92	50
BW-ALB250	2 1/2	1.09	40
BW-ALB300	3	1.64	25
BW-ALB400	4	2.51	25
BW-ALB500	5	3.43	4
BW-ALB600	6	5.08	10
BW-ALB800	8	8.15	2



Stainless Steel 316 Part F Male Adapter

Part Number	Size (in.)	Weight Each (lbs.)	Standard Carton
BW-SSF150	1 1/2	1.40	25
BW-SSF200	2	1.57	20
BW-SSF250	2 1/2	2.80	12
BW-SSF300	3	4.17	8
BW-SSF400	4	6.57	6
BW-SSF500	5	8.51	4
BW-SSF600	6	11.52	2



Stainless Steel 316 Part B Female Coupler

Part Number	Size (in.)	Weight Each (lbs.)	Standard Carton
BW-SSB150	1 1/2	1.27	20
BW-SSB200	2	1.57	20
BW-SSB250	2 1/2	2.13	12
BW-SSB300	3	3.21	8
BW-SSB400	4	5.72	6
BW-SSB500	5	6.71	4
BW-SSB600	6	9.13	2

See applications and specifications on pages 25 & 26.

Because we continually examine ways to improve our products, we reserve the right to alter specifications or discontinue products without prior notice.



Quick-Acting Weld Couplings SW Items are Designed for Socket Weld to Schedule 40 Pipe



Aluminum Part A Male Adapter

Part Number	Size (in.)	Weight Each (lbs.)	Standard Carton
SW-ALA150	1 1/2	0.37	30
SW-ALA200	2	0.45	40
SW-ALA250	2 1/2	0.65	50
SW-ALA300	3	0.77	35
SW-ALA400	4	1.41	20
SW-ALA500	5	1.70	4
SW-ALA600	6	2.08	15



Aluminum Part D Female Coupler

Part Number	Size (in.)	Weight Each (lbs.)	Standard Carton
SW-ALD150	1 1/2	0.81	30
SW-ALD200	2	0.99	40
SW-ALD250	2 1/2	1.27	35
SW-ALD300	3	1.69	20
SW-ALD400	4	2.91	10
SW-ALD500	5	4.56	10
SW-ALD600	6	5.28	10



Stainless Steel 316 Part A Male Adapter

Part Number	Size (in.)	Weight Each (lbs.)	Standard Carton
SW-SSA150	1 1/2	0.71	25
SW-SSA200	2	1.37	12
SW-SSA250	2 1/2	1.38	12
SW-SSA300	3	1.87	8
SW-SSA400	4	3.95	6
SW-SSA500	5	4.46	4
SW-SSA600	6	6.16	2



Stainless Steel 316 Part D Female Coupler

Part Number	Size (in.)	Weight Each (lbs.)	Standard Carton
SW-SSD150	1 1/2	1.41	30
SW-SSD200	2	1.70	40
SW-SSD250	2 1/2	2.35	35
SW-SSD300	3	3.30	20
SW-SSD400	4	5.32	10
SW-SSD500	5	7.81	10
SW-SSD600	6	20.79	10

See applications and specifications on pages 25 & 26.

Because we continually examine ways to improve our products, we reserve the right to alter specifications or discontinue products without prior notice.



Quick-Acting Special Application Couplings Aluminum

Aluminum Reducing Coupler x Hose Shank



Part Number	Size (in.)	Weight Each (lbs.)	Standard Carton
AL-C2015	2 x 1/1/2	0.93	40
AL-C3020	3 x 2	1.74	9
AL-C3040	3 x 4	2.29	8
AL-C4030	4 x 3	2.94	6



Aluminum Reducing Adapter x Hose Shank

Part Number	Size (in.)	Weight Each (lbs.)	Standard Carton
AL-E2015	2 x 1/1/2	0.64	50
AL-E3020	3 x 2	1.12	12
AL-E3040	3 x 4	1.90	8
AL-E4030	4 x 3	2.03	18

Aluminum Reducing Coupler x Male NPT



Part Number	Size (in.)	Weight Each (lbs.)	Standard Carton
AL-B2030	2 x 3	1.43	12
AL-B3020	3 x 2	1.57	12
AL-B3040	3 x 4	2.45	18
AL-B4030	4 x 3	2.31	10



Aluminum Reducing Adapter x Male NPT

Part Number	Size (in.)	Weight Each (lbs.)	Standard Carton
AL-F2030	2 x 3	1.06	20
AL-F3020	3 x 2	0.86	24
AL-F3040	3 x 4	1.78	25
AL-F4030	4 x 3	1.57	18

*** NEW SIZE**

Aluminum Reducing Coupler x Adapter



Part Number	Size (in.)	Weight Each (lbs.)	Standard Carton
RDA-A2030	2 x 3	1.64	12
RDA-A3020	3 x 2	2.37	6
RDA-A3040	3 x 4	2.60	6
RDA-A4020	4 x 2	2.70	6
RDA-A4030	4 x 3	2.96	6
RDA-A6040	6 x 4	6.66	2
* RDA-A8060	8 x 6	10.40	4



Aluminum Spool Adapter

Part Number	Size (in.)	Weight Each (lbs.)	Standard Carton
SA-A150	1 1/2	0.43	50
SA-A200	2	0.68	40
SA-A2030	2 x 3	0.97	12
SA-A300	3	1.10	12
SA-A3040	3 x 4	1.78	8
SA-A400	4	1.91	6

Aluminum Elbow Coupler x Adapter



Part Number	Size (in.)	Weight Each (lbs.)	Standard Carton
DA90-A200	2	1.50	16
DA90-A300	3	2.17	10
DA90-A400	4	4.30	5



Aluminum Coupler x Coupler

Part Number	Size (in.)	Weight Each (lbs.)	Standard Carton
DD-AL200	2	1.43	12
DD-AL2030	2 x 3	4.35	9
DD-AL300	3	2.40	6
DD-AL3040	3 x 4	5.90	12
DD-AL400	4	3.90	5

Aluminum Coupler x 150# ASA Flange



Part Number	Size (in.)	Weight Each (lbs.)	Standard Carton
FL-AL-D200	2	2.35	4
FL-AL-D300	3	5.07	3
FL-AL-D400	4	7.94	2
FL-AL-D600	6	12.89	1



Aluminum Adapter x 150# ASA Flange

Part Number	Size (in.)	Weight Each (lbs.)	Standard Carton
FL-AL-A200	2	3.05	6
FL-AL-A300	3	3.86	4
FL-AL-A400	4	5.86	3
FL-AL-A600	6	9.92	2

See applications and specifications on page 25.

Because we continually examine ways to improve our products, we reserve the right to alter specifications or discontinue products without prior notice.



Quick-Acting Special Application Couplings Brass



Brass Reducing Coupler x Adapter

Part Number	Size (in.)	Weight Each (lbs.)	Standard Carton
RDA-B2030	2 x 3	2.86	6
RDA-B3020	3 x 2	6.12	6
RDA-B4020	4 x 2	7.07	6
RDA-B4030	4 x 3	9.42	6



Brass Pool Adapter

Part Number	Size (in.)	Weight Each (lbs.)	Standard Carton
SA-B150	1 1/2	1.35	50
SA-B200	2	2.11	40
SA-B250	2 1/2	3.55	30
SA-B300	3	3.69	20
SA-B400	4	5.97	6

*** NEW SIZE**

Stainless Steel 316



Stainless Steel SS316 Reducing Coupler x Adapter

Part Number	Size (in.)	Weight Each (lbs.)	Standard Carton
* RDA-SS2030	2 x 3	3.45	6
RDA-SS3020	3 x 2	4.08	6
RDA-SS4030	4 x 3	6.41	4
RDA-SS6040	6 x 4	12.10	2



Stainless Steel SS316 Pool Adapter

Part Number	Size (in.)	Weight Each (lbs.)	Standard Carton
SA-SS150	1 1/2	1.76	18
SA-SS1520	1 1/2 x 2	2.10	20
SA-SS200	2	2.48	20
SA-SS2030	2 x 3	3.14	10
SA-SS300	3	4.61	10
SA-SS3040	3 x 4	5.28	6
SA-SS400	4	7.28	6



Stainless Steel SS316 Coupler x Coupler

Part Number	Size (in.)	Weight Each (lbs.)	Standard Carton
DD-SS150	1 1/2	2.10	20
DD-SS200	2	2.89	12
DD-SS300	3	5.11	6
DD-SS400	4	6.66	5

Polypropylene



Polypropylene 90° Coupler x Hose Shank

Part Number	Size (in.)	Weight Each (lbs.)	Standard Carton
PP150C90	1 1/2	0.56	24
PP200C90	2	0.73	24



Polypropylene 90° Male Adapter x Female NPT

Part Number	Size (in.)	Weight Each (lbs.)	Standard Carton
PP150A90	1 1/2	0.23	24
PP200A90	2	0.36	24



Polypropylene 90° Coupler x Female NPT

Part Number	Size (in.)	Weight Each (lbs.)	Standard Carton
PP150D90	1 1/2	0.65	24
PP200D90	2	0.78	24



Polypropylene 90° Male Adapter x Male NPT

Part Number	Size (in.)	Weight Each (lbs.)	Standard Carton
PP150F90	1 1/2	0.27	24
PP200F90	2	0.41	24

See applications and specifications on pages 25 - 27.

Because we continually examine ways to improve our products, we reserve the right to alter specifications or discontinue products without prior notice.



Petroleum Quick-Acting Couplings

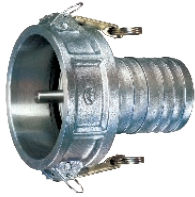

Aluminum Vapor Recovery Coupler with Probe Female Coupler x Hose Shank

Part Number	Size (in.)	Weight Each (lbs.)	Standard Carton
VRP-A4030	4 x 3	3.04	4
VRP-A4040	4 x 4	3.15	4



Aluminum Vapor Recovery Coupler with Probe Female Coupler x Male Coupler

Part Number	Size (in.)	Weight Each (lbs.)	Standard Carton
DAP-4030	4 x 3	3.54	4



Aluminum Vapor Recovery Coupler with Probe Female Coupler x Female NPT

Part Number	Size (in.)	Weight Each (lbs.)	Standard Carton
CGDP-A4030	4 x 3	3.08	4
CGDP-A4040	4 x 4	3.80	4



NEW

Aluminum Vapor Recovery Coupler with Probe Female Coupler Poppet with Viton Seal x Hose Shank

Part Number	Size (in.)	Weight Each (lbs.)	Standard Carton
VRP-P4030	4 x 3	4.01	5



API Aluminum Female Coupler x Male Adapter

Part Number	Size (in.)	Weight Each (lbs.)	Standard Carton
TCDA-A4030	4 x 3	4.25	4
TCDA-A4040	4 x 4	4.50	4



API Aluminum Female Coupler x Female Coupler

Part Number	Size (in.)	Weight Each (lbs.)	Standard Carton
TCDD-A4040	4 x 4	6.00	2



API Aluminum Dust Cap

Part Number	Size (in.)	Weight Each (lbs.)	Standard Carton
TCDC-A400	4	3.00	6

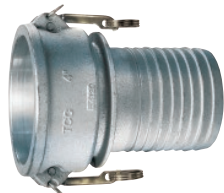

Aluminum HD Part C Female Coupler x Hose Shank

Part Number	Size (in.)	Weight Each (lbs.)	Standard Carton
TCC-300-A	3	2.65	15
TCC-400-A	4	3.70	15



Brass Probe

Part Number	Size (in.)	Weight Each (lbs.)	Standard Carton
VRP-PROBE	3/16	0.14	1

See applications and specifications on page 25.

Because we continually examine ways to improve our products, we reserve the right to alter specifications or discontinue products without prior notice.



Quick-Acting Swivel Couplings

Our specially designed quick-acting swivel couplings come with a Buna-N O-Ring and minimize the torque and twisting that occurs when a hose is in service.



Aluminum Female Coupler x SS304 Female NPT Swivel

Part Number	Size (in.)	Weight Each (lbs.)	Standard Carton
KAS-C401	4	5.20	1
KAS-C501	5	6.53	1
KAS-C601	6	10.49	1



Aluminum Male Adapter x SS304 Female NPT Swivel

Part Number	Size (in.)	Weight Each (lbs.)	Standard Carton
KAS-E401	4	4.67	1
KAS-E501	5	5.42	1
KAS-E601	6	6.97	1



SS304 Male Adapter x SS304 Female NPT Swivel

Part Number	Size (in.)	Weight Each (lbs.)	Standard Carton
KSS-E401	4	6.12	1
KSS-E501	5	7.61	1
KSS-E601	6	11.07	1

Suggested for use with Tigerflex™ 4" ID hoses

Z-Lok™ Investment cast stainless steel LTW™ (Lifetime Warranty) handles.



Safety clip provides positive locking.

Stainless steel ball bearings ensure smooth swivel action.



White Nitrile gasket helps prevent product contamination.

New SmoothFlow™ tapered throat design provides full flow . . . reduces pressure drop and material build-up in hose.

SureSeal™ Aluminum Collar Clamp (included) provides positive seal . . . eliminates cutting of hose at shank end.



Aluminum Female Coupler x Hose Shank

Part Number	Size (in.)	Weight Each (lbs.)	Standard Carton
SCAL-C400	4	5.50	4

Aluminum Male Adapter x Hose Shank

Part Number	Size (in.)	Weight Each (lbs.)	Standard Carton
SCAL-E400	4	3.20	4

White Nitrile Gasket

Part Number	Size (in.)	Weight Each (lbs.)	Standard Carton
WNIT400	4	0.066	10

PSI Rating @ 70°F (+21°C)

4"	72 PSI
5" x 6"	35 PSI

See applications and specifications on pages 25 & 26.

Because we continually examine ways to improve our products, we reserve the right to alter specifications or discontinue products without prior notice.



K-Loc™ Auto Lock SS316 Quick-Acting Couplings



K-Loc™ Part C Female Coupler x Hose Shank

Part Number	Size (in.)	Weight Each (lbs.)	Standard Carton
KLOC-SS-C150	1 1/2	1.87	15
KLOC-SS-C200	2	2.80	10
KLOC-SS-C300	3	5.22	5



K-Loc™ Part D Female Coupler x Female NPT

Part Number	Size (in.)	Weight Each (lbs.)	Standard Carton
KLOC-SS-D150	1 1/2	1.74	20
KLOC-SS-D200	2	2.26	16
KLOC-SS-D300	3	3.85	4



K-Loc™ Part DC Dust Cap

Part Number	Size (in.)	Weight Each (lbs.)	Standard Carton
KLOC-SS-DC200	2	1.89	18
KLOC-SS-DC300	3	3.33	8



K-Loc™ Part B Female Coupler x Male NPT

Part Number	Size (in.)	Weight Each (lbs.)	Standard Carton
KLOC-SS-B150	1 1/2	1.57	20
KLOC-SS-B200	2	2.00	16
KLOC-SS-B300	3	3.63	4

Aluminum Compression Quick-Acting Couplings

Note: Compression Couplings are for attachment to .065" aluminum tubing for dry pneumatic systems only.



Aluminum Part BC Female Coupler x Compression

Part Number	Size (in.)	Weight Each (lbs.)	Standard Carton
BCAL150	1 1/2	0.96	25
BCAL200	2	1.16	20
BCAL250	2 1/2	1.54	12
BCAL300	3	2.08	10

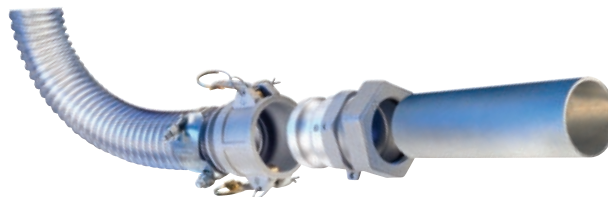

Aluminum Part FC Male Adapter x Compression

Part Number	Size (in.)	Weight Each (lbs.)	Standard Carton
FCAL150	1 1/2	0.52	25
FCAL200	2	0.72	20
FCAL250	2 1/2	1.32	12
FCAL300	3	1.46	10



See applications and specifications on pages 25 & 26.

Because we continually examine ways to improve our products, we reserve the right to alter specifications or discontinue products without prior notice.



Quick-Acting Coupling Specifications

Applications

Agriculture • Chemicals • Petroleum • Construction • Material Handling • Irrigation • Fracking

Aluminum

Features & Benefits

- All sizes except 1/2", 5" and 8" comply with Mil-Spec A-A-59326 for interchangeability
- 5" Size complies with ASTM specs for interchangeability
- 1/2" x 1/2" are not specified under Mil Specs
- All 8" and 10" female couplers supplied with 4 locking handles, safety clips, pull rings and chains
- Aluminum alloy is specially designed for high tensile strength, lightness and rigidity
- Locking feature using safety clips to prevent disconnection during use on all sizes except 1/2"
- Hose shanks specially designed for easy assembly with Tigerflex type hoses
- Aluminum couplings supplied with brass handles which results in less wear on connecting parts

Aluminum 8" Coupling Options

- Kuriyama offers both 8" coupling styles in aluminum
- Standard AL-(X)800 couplings interchange with PT Domestic, Dixon Global, Campbell, and Jason
- Heavy Duty HDAL-(X)801 couplings interchange with PT Import, Dixon Andrews, NECO, Ever-Tite, UPD, and Sealfast

Material Specifications

- ASTM B85 Grade 383 aluminum alloy
- Forged brass handles - aluminum items
- Type 304 stainless steel handles - ALSH items
- Zinc-plated carbon steel handle pins
- Zinc-plated carbon steel pull rings
- Zinc-plated carbon steel safety clips
- Buna-N Gaskets

PSI Rating @ 70°F (+21°C)

1/2" – 2"	250 PSI
2 1/2" – 4"	150 PSI
5" – 6"	75 PSI
8" – 10"	50 PSI

Brass

Features & Benefits

- All sizes except 1/2" and 5" comply with Mil-Spec A-A-59326 for interchangeability
- 5" Size complies with ASTM specs for interchangeability
- 1/2" x 1/2" are not specified under Mil Specs
- Brass alloy is specially designed for high tensile strength and rigidity
- Locking feature using safety clips to prevent disconnection during use on all sizes except 1/2"

Material Specifications

- ASTM B584 Grade C85700 brass alloy
- Forged brass handles
- Type 304 stainless steel handle pins
- Type 304 stainless steel pull rings
- Zinc-plated carbon steel safety clips
- Buna-N Gaskets

PSI Rating @ 70°F (+21°C)

1/2" – 2"	250 PSI
2 1/2" – 4"	150 PSI
5" – 6"	75 PSI

Because we continually examine ways to improve our products, we reserve the right to alter specifications or discontinue products without prior notice.



Quick-Acting Coupling Specifications

Applications

Agriculture • Chemicals • Petroleum • Construction • Material Handling • Irrigation • Fracking

316 Stainless Steel

Features & Benefits

- All sizes except 1/2" and 5" comply with Mil-Spec A-A-59326 for material and interchangeability
- 5" Size complies with ASTM specs for interchangeability
- 1/2" x 1/2" are not specified under Mil Specs
- Stainless steel alloy chemical composition is analyzed on every melt
- Composition test certificate is available upon request
- Locking feature using safety clips to prevent disconnection during use on all sizes except 1/2"

Material Specifications

- ASTM A666 316 stainless steel alloy
- Type 304 stainless steel handles
- Type 304 stainless steel handle pins
- Type 304 stainless steel pull rings
- Type 304 stainless steel safety clips
- Buna-N Gaskets

PSI Rating @ 70°F (+21°C)

1/2" – 2"	250 PSI
2 1/2" – 4"	150 PSI
5" – 6"	75 PSI

304 Stainless Steel

Features & Benefits

- All sizes except 1/2" and 5" comply with Mil-Spec A-A-59326 for material and interchangeability
- 5" Size complies with ASTM specs for interchangeability
- 1/2" x 1/2" are not specified under Mil Specs
- Stainless steel alloy chemical composition is analyzed on every melt
- Composition test certificate is available upon request
- Locking feature using safety clips to prevent disconnection during use on all sizes except 1/2"

Material Specifications

- ASTM A666 304 stainless steel alloy
- Type 304 stainless steel handles
- Type 304 stainless steel handle pins
- Type 304 stainless steel pull rings
- Type 304 stainless steel safety clips
- Buna-N Gaskets

PSI Rating @ 70°F (+21°C)

1/2" – 2"	250 PSI
2 1/2" – 4"	150 PSI
5" – 6"	75 PSI

Because we continually examine ways to improve our products, we reserve the right to alter specifications or discontinue products without prior notice.



Quick-Acting Coupling Specifications

Applications

Agriculture • Chemicals • Petroleum • Construction • Material Handling • Irrigation • Fracking

Polypropylene

Features & Benefits

- All sizes except 1/2" comply with Mil-Spec A-A-59326 for interchangeability
- 1/2" x 1/2" are not specified under Mil Specs
- Polypropylene material is glass-filled for added strength and durability
- Locking feature using safety clips to prevent disconnection during use on all sizes except 1/2"
- All 4" size female couplers are supplied with three locking handles to provide added stability

Material Specifications

- Type 304 stainless steel handles
- Type 304 stainless steel handle pins
- Type 304 stainless steel pull rings
- Type 304 stainless steel safety clips
- EPDM gaskets

PSI Rating @ 70°F (+21°C)

1/2" – 2"	100 PSI
3" – 4"	50 PSI

Glass Reinforced Nylon

Features & Benefits

- All sizes comply with Mil-Spec A-A-59326 for interchangeability
- Nylon material is fiberglass reinforced for high tensile strength and durability
- Locking feature using safety clips to prevent disconnection during use on all sizes
- All 4" size female couplers are supplied with three locking handles to provide added stability

Material Specifications

- Type 304 stainless steel handles
- Type 304 stainless steel handle pins
- Type 304 stainless steel pull rings
- Type 304 stainless steel safety clips
- EPDM gaskets

PSI Rating @ 70°F (+21°C)

1/2" – 2"	100 PSI
3" – 4"	50 PSI

Ductile Iron

Features & Benefits

- All sizes comply with Mil-Spec A-A-59326 for interchangeability
- Coupling ID is specially designed for maximum flow of product
- Locking feature using safety clips to prevent disconnection during use on all sizes

Material Specifications

- Type 304 stainless steel handles
- Type 304 stainless steel handle pins
- Type 304 stainless steel pull rings
- Zinc-plated carbon steel safety clips
- BUNA gaskets

PSI Rating @ 70°F (+21°C)

4"	150 PSI
----	---------

Because we continually examine ways to improve our products, we reserve the right to alter specifications or discontinue products without prior notice.



Hammer Unions



Figure 100 Threaded 1000 PSI CWP
Economical Low Pressure Union

Part Number	Size (in.)	Weight Each (lbs.)	Standard Carton
HUT100-2	2	5.29	6
HUT100-3	3	11.60	5
HUT100-4	4	17.75	3
HUT100-6	6	44.40	1
HUT100-8	8	69.90	1



Figure 400 Threaded 4000 PSI CWP
Medium Pressure Union

Part Number	Size (in.)	Weight Each (lbs.)	Standard Carton
HUT400-2	2	11.00	4
HUT400-3	3	19.60	2
HUT400-4	4	29.65	1



Figure 200 Threaded 2000 PSI CWP
General Purpose Union

Part Number	Size (in.)	Weight Each (lbs.)	Standard Carton
HUT200-1	1	1.55	30
HUT200-2	2	4.55	12
HUT200-3	3	11.70	5
HUT200-4	4	19.00	3
HUT200-6	6	44.40	1
HUT200-8	8	71.45	1



Figure 602 Threaded 6000 PSI CWP
Specially Designed Lip Type Elastomer Seal Protects Metal to Metal Sealing Surface and Reduces Line Flow Turbulence

Part Number	Size (in.)	Weight Each (lbs.)	Standard Carton
HUT602-1	1	3.75	4
HUT602-2	2	12.90	4
HUT602-3	3	22.80	2
HUT602-4	4	37.04	1



NEW SIZES

Figure 206 Threaded 2000 PSI CWP
General Purpose Union With O-Ring in Male Sub for Improved Sealing

Part Number	Size (in.)	Weight Each (lbs.)	Standard Carton
HUT206-2	2	4.60	12
HUT206-3	3	11.80	5
HUT206-4	4	19.10	3
HUT206-6	6	45.00	1
HUT206-8	8	66.00	1



Figure 1002 Threaded 10,000 PSI CWP
Specially Designed Lip Type Elastomer Seal Protects Metal to Metal Sealing Surface and Reduces Line Flow Turbulence

Part Number	Size (in.)	Weight Each (lbs.)	Standard Carton
HUT1002-2	2	12.60	4
HUT1002-3	3	22.60	2
HUT1002-4	4	36.10	1

See applications and specifications on page 29.

Because we continually examine ways to improve our products, we reserve the right to alter specifications or discontinue products without prior notice.



Hammer Unions



Figure 602 Butt Weld 6000 PSI CWP

Specially Designed Lip Type Elastomer Seal Protects Metal to Metal Sealing Surface and Reduces Line Flow Turbulence

Part Number	Size (in.)	Weight Each (lbs.)	Standard Carton
HUW602-2	2	13.85	4
HUW602-3	3	26.30	2
HUW602-4	4	37.90	1



Figure 1002 Butt Weld 10,000 PSI CWP

Specially Designed Lip Type Elastomer Seal Protects Metal to Metal Sealing Surface and Reduces Line Flow Turbulence

Part Number	Size (in.)	Weight Each (lbs.)	Standard Carton
HUW1002-2	2	13.95	4
HUW1002-3	3	25.80	2
HUW1002-4	4	37.50	1



Figure 1502 Threaded 15,000 PSI CWP

Specially Designed Lip Type Elastomer Seal Protects Metal to Metal Sealing Surface and Reduces Line Flow Turbulence

Part Number	Size (in.)	Weight Each (lbs.)	Standard Carton
HUT1502-2	2	18.96	2
HUT1502-3	3	27.56	2



Figure 1502 Butt Weld 15,000 PSI CWP

Specially Designed Lip Type Elastomer Seal Protects Metal to Metal Sealing Surface and Reduces Line Flow Turbulence

Part Number	Size (in.)	Weight Each (lbs.)	Standard Carton
HUW1502-2	2	20.00	2
HUW1502-3	3	29.10	2
HUW1502-4	4	78.55	1

Specifications

Features & Benefits

- Applications include oil, gas, air, and water
- Unions conform to NACE, ISO and DNV standards
- Color coded for easy identification
- CWP (Cold Working Pressure) is the maximum pressure at 70°F (+21°C)
- Unions are completely interchangeable with competitors of like products

Material Specifications

- ASTM Grade 65-45-12
- ASTM A-105
- ASTM A29
- NPT threads conform to ASME B1.20.1
- Elastomer seals are BUNA-N

CWP Rating @ 70°F (+21°C)

Figure 100	1000 PSI
Figure 200	2000 PSI
Figure 206	2000 PSI
Figure 400	4000 PSI
Figure 602	6000 PSI
Figure 1002	10,000 PSI
Figure 1502	15,000 PSI

Because we continually examine ways to improve our products, we reserve the right to alter specifications or discontinue products without prior notice.



Hammer Unions - Barbed



Figure 206 Barbed 300 PSI CWP

Specially Designed Lip Type Elastomer Seal Protects Metal to Metal Sealing Surface and Reduces Line Flow Turbulence

Part Number	Size (in.)	Weight Each (lbs.)	Standard Carton
HUB206-4	4	32.00	1

Specifications

Features & Benefits

- Suitable for fracking water and sand slurry applications
- Interchangeable with all Figure 206 Hammer Unions
- Versatility of barbs allow for use with either interlocking crimp ferrules or crimp sleeves
- Eliminates leak paths created with threaded fittings

Material Specifications

- Hammer nut conforms to ASTM A-105
- Working pressures up to 300 PSI with interlocking crimp ferrules
- Elastomer seals are BUNA-N
- Zinc plated machined malleable iron hose barbs

Because we continually examine ways to improve our products, we reserve the right to alter specifications or discontinue products without prior notice.



Valves



Polypropylene Ball Valve 4-Bolt Design

Part Number	Size (in.)	Weight Each (lbs.)	Standard Carton
PPBV050	1/2	0.88	24
PPBV075	3/4	0.85	24
PPBV100	1	1.16	24
PPBV125	1 1/4	1.65	24
PPBV150	1 1/2	1.67	24

Polypropylene Ball Valve 6-Bolt Design

Part Number	Size (in.)	Weight Each (lbs.)	Standard Carton
PPBV200	2	3.71	8
PPBV300	3	6.60	6
PPBV400	4	9.90	2

PPBV Specifications

Features & Benefits

- Full port
- Stainless steel bolts and nuts
- Teflon™ seals
- Viton® O-Ring stems and seals
- Polypropylene material is glass filled for extra strength
- Female NPT threads

PSI Rating @ 70°F (+21°C)

1/2" - 1 1/2"	150 PSI
2" - 4"	100 PSI

Viton® is a registered trademark of DuPont Performance Elastomers.
Teflon™ is a registered trademark of The Chemours Company FC, LLC.



Foot Valve

Part Number	Size (in.)	Weight Each (lbs.)	Standard Carton
FV150	1 1/2	2.90	12
FV200	2	5.30	8
FV250	2 1/2	7.30	6
FV300	3	9.00	5
FV400	4	17.90	2
FV600	6	46.60	1
FV800	8	93.70	1

Kuriyama foot valves are made of cast iron and come with a neoprene flapper valve assembly. Threads are NPT; bolts and nuts are plated steel. Designed for use in irrigation and other pumping applications where water may be dirty due to silt and sand to prevent passage of contaminants to the pump.

Because we continually examine ways to improve our products, we reserve the right to alter specifications or discontinue products without prior notice.



Sight Glasses



*** NEW SIZE**

Sight Glass (NPT Threads)

Part Number	Size (in.)	Length (in.)	Weight Each (lbs.)	Standard Carton
* SG200	2	8	0.87	30
SG300	3	8	1.08	12
SG400	4	8	2.25	6

Sight Glass is made from a tough polycarbonate material and has a temperature rating of (-50°F to +185°F). It has a 500 PSI rating and allows for viewing of materials at all times.

Funnel Strainers

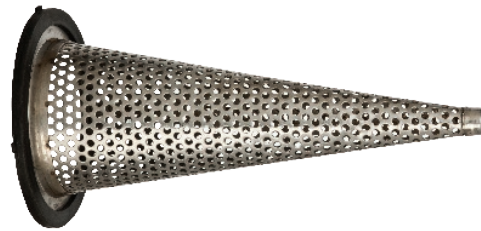

*** NEW SIZE**

Funnel Strainer (304 Stainless Steel)

Part Number	Size (in.)	Length (in.)	Hole Size (in.)	Weight Each (lbs.)	Standard Carton
* FNS200	2	3.65	0.158	0.08	120
FNS300	3	6.30	0.158	0.19	90
FNS400	4	9.50	0.158	0.45	65

Funnel Strainer is made of 304 stainless steel and offers a unique one-piece design which includes a pre-attached buna gasket for better sealing and ease of assembly. It is designed to be used with female quick-acting couplings.

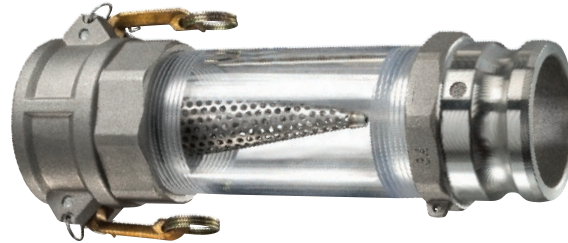

The pictures above show a popular installation set up for the Sight Glass and Funnel Strainer. The picture on the left shows the Funnel Strainer assembled with an aluminum type "D" coupling. The picture on the right shows the complete assembly with the Sight Glass and an aluminum type "A" coupling. **Warning: Never use a wrench on the Sight Glass – always tighten the connecting pieces.**

Aluminum Plate Strainers



*** NEW SIZE**

Aluminum Plate Strainer (NPT Threads)

Part Number	Size (in.)	Hole Size (in.)	Weight Each (lbs.)	Standard Carton
* APS200	2	0.25	0.055	120
APS300	3	0.25	0.088	90
APS400	4	0.25	0.132	75

Aluminum Plate Strainer is made to thread into the bottom of a female NPT quick-acting coupler (shown above). It protects pumps and other equipment from large contaminants. "Easy Grip" handle pin design allows for easy assembly.

Because we continually examine ways to improve our products, we reserve the right to alter specifications or discontinue products without prior notice.



Strainers



* NEW SIZES



**Round Hole Zinc Plated Steel Strainer
(NPSM Threads)**

Part Number	Size (in.)	Weight Each (lbs.)	Standard Carton
RHS150	1 1/2	1.36	32
RHS200	2	1.78	18
RHS250	2 1/2	2.02	18
RHS300	3	3.08	18
RHS400	4	2.90	18
RHS600	6	6.04	6
RHS800	8	7.34	4
* RHS1000	10	26.50	1

**Square Hole Zinc Plated Steel Strainer
(NPSM Threads)**

Part Number	Size (in.)	Weight Each (lbs.)	Standard Carton
SHS150	1 1/2	1.12	32
SHS200	2	1.74	18
SHS300	3	2.50	18
SHS400	4	2.52	18
SHS600	6	6.32	6
* SHS800	8	7.34	4
* SHS1000	10	26.50	1

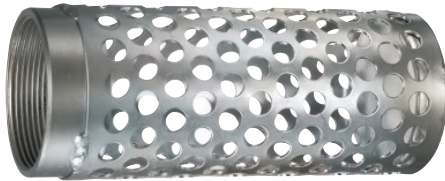

**Long Round Hole Zinc Plated Steel Strainer
(NPSM Threads)**

Part Number	Size (in.)	Weight Each (lbs.)	Standard Carton
LHS150	1 1/2	0.75	30
LHS200	2	0.94	25
LHS300	3	2.00	16



**Polypropylene Strainer
(NPSM Threads)**

Part Number	Size (in.)	Weight Each (lbs.)	Standard Carton
PPS150	1 1/2	0.25	18
PPS200	2	0.30	18
PPS300	3	0.65	12



**Top Hole Zinc Plated Steel Strainer
(NPSM Threads)**

Part Number	Size (in.)	Weight Each (lbs.)	Standard Carton
THS150	1 1/2	1.64	25
THS200	2	2.00	20
THS300	3	2.68	15



**Bottom Hole Zinc Plated Steel Strainer
(NPSM Threads)**

Part Number	Size (in.)	Weight Each (lbs.)	Standard Carton
BHS150	1 1/2	1.64	20
BHS200	2	2.00	20
BHS300	3	2.68	15

Because we continually examine ways to improve our products, we reserve the right to alter specifications or discontinue products without prior notice.



Combination Hose Nipples

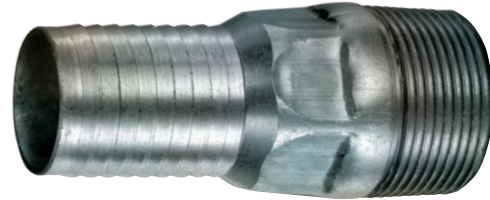

Hose Nipple (Plain Steel) NPT Threads

Part Number	Size (in.)	Weight Each (lbs.)	Standard Carton
STN050	1/2	0.14	25
STN075	3/4	0.22	25
STN100	1	0.32	50
STN125	1 1/4	0.56	20
STN150	1 1/2	0.72	10
STN200	2	1.10	40
STN250	2 1/2	1.74	20
STN300	3	2.18	12
STN400	4	3.22	8
STN500	5	4.12	4
STN600	6	12.24	4

Hose Nipple (Hex Plain Steel) NPT Threads

Part Number	Size (in.)	Weight Each (lbs.)	Standard Carton
HEX-STN050	1/2	0.14	25
HEX-STN075	3/4	0.22	25
HEX-STN100	1	0.32	50
HEX-STN125	1 1/4	0.56	20

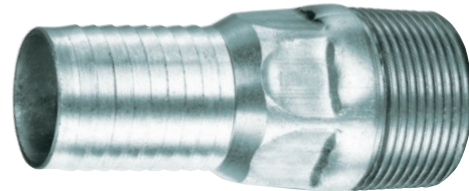

Hose Nipple (Hex Zinc Plated Steel) NPT Threads

Part Number	Size (in.)	Weight Each (lbs.)	Standard Carton
HEX-SPN050	1/2	0.14	25
HEX-SPN075	3/4	0.22	25
HEX-SPN100	1	0.32	50
HEX-SPN125	1 1/4	0.56	20

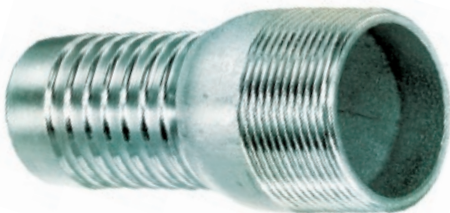

Hose Nipple (Zinc Plated Steel) NPT Threads

Part Number	Size (in.)	Weight Each (lbs.)	Standard Carton
SPN050	1/2	0.14	25
SPN075	3/4	0.22	25
SPN100	1	0.32	50
SPN125	1 1/4	0.56	20
SPN150	1 1/2	0.72	10
SPN200	2	1.10	40
SPN250	2 1/2	1.74	20
SPN300	3	2.18	12
SPN400	4	3.22	8
SPN600	6	12.24	4
SPN800	8	16.44	2
SPN1000	10	21.78	1
SPN1200	12	33.18	1



NEW

Hose Nipple (Zinc Plated Steel) Grooved End

Part Number	Size (in.)	Weight Each (lbs.)	Standard Carton
GEN100	1	0.58	100
GEN125	1 1/4	0.62	80
GEN150	1 1/2	0.86	60
GEN200	2	1.28	50
GEN250	2 1/2	2.03	20
GEN300	3	3.17	20
GEN400	4	3.88	12
GEN600	6	14.60	4
GEN800	8	19.73	2
GEN1000	10	26.14	1
GEN1200	12	39.82	1

Because we continually examine ways to improve our products, we reserve the right to alter specifications or discontinue products without prior notice.



Combination Hose Nipples



Hose Nipple (304 Stainless) NPT Threads

Part Number	Size (in.)	Weight Each (lbs.)	Standard Carton
SSN304-050	1/2	0.18	25
SSN304-075	3/4	0.26	25
SSN304-100	1	0.35	50
SSN304-125	1 1/4	0.55	20
SSN304-150	1 1/2	0.66	10
SSN304-200	2	1.16	40
SSN304-250	2 1/2	1.31	20
SSN304-300	3	2.20	12
SSN304-400	4	3.31	8
SSN304-500	5	8.82	4
SSN304-600	6	11.02	4

Hose Nipple (316 Stainless) NPT Threads

Part Number	Size (in.)	Weight Each (lbs.)	Standard Carton
SSN050	1/2	0.18	25
SSN075	3/4	0.26	25
SSN100	1	0.35	50
SSN125	1 1/4	0.55	20
SSN150	1 1/2	0.66	10
SSN200	2	1.16	40
SSN250	2 1/2	1.31	20
SSN300	3	2.20	12
SSN400	4	3.31	8
SSN500	5	8.82	4
SSN600	6	11.02	4



Hose Nipple (Polypropylene) NPT Threads

Part Number	Size (in.)	Weight Each (lbs.)	Standard Carton
PPN050	1/2	0.03	400
PPN075	3/4	0.06	200
PPN100	1	0.07	100
PPN125	1 1/4	0.11	80
PPN150	1 1/2	0.13	60
PPN200	2	0.22	40
PPN300	3	0.55	12

Hose Nipple (Glass Reinforced Nylon) NPT Threads

Part Number	Size (in.)	Weight Each (lbs.)	Standard Carton
GRN050	1/2	0.03	400
GRN075	3/4	0.06	200
GRN100	1	0.07	100
GRN125	1 1/4	0.11	80
GRN150	1 1/2	0.13	60
GRN200	2	0.22	40
GRN300	3	0.55	12
GRN400	4	0.80	12

PSI Rating @ 70°F (+21°C)

Steel, Plated Steel, Stainless Steel Polypropylene

1/2" – 1 1/2"	125 PSI
2" – 6"	75 PSI
8" – 12"	50 PSI

Glass Reinforced Nylon

1/2" – 2"	150 PSI
3"	125 PSI
4"	75 PSI

Because we continually examine ways to improve our products, we reserve the right to alter specifications or discontinue products without prior notice.



Pin Lug Hose Shank Couplings

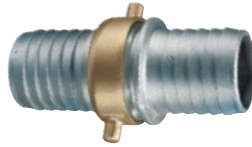

Aluminum Shank with Brass Swivel Nut Complete Set (NPSM Threads)

Part Number	Size (in.)	Weight Each (lbs.)	Standard Carton
AB150	1 1/2	0.56	75
AB200	2	0.88	40
AB250	2 1/2	1.34	18
AB300	3	2.70	12
AB400	4	4.42	10
AB600	6	8.30	4



Brass Shank with Brass Swivel Nut Complete Set (NPSM Threads)

Part Number	Size (in.)	Weight Each (lbs.)	Standard Carton
BB150	1 1/2	1.17	35
BB200	2	1.98	30
BB300	3	5.00	12
BB400	4	9.38	6



Aluminum Shank Male (NPSM Threads)

Part Number	Size (in.)	Weight Each (lbs.)	Standard Carton
ABM150	1 1/2	0.18	150
ABM200	2	0.25	80
ABM250	2 1/2	0.40	36
ABM300	3	1.04	24
ABM400	4	1.70	20
ABM600	6	3.04	8



Aluminum Shank with Brass Swivel Nut Female (NPSM Threads)

Part Number	Size (in.)	Weight Each (lbs.)	Standard Carton
ABF150	1 1/2	0.38	150
ABF200	2	0.62	80
ABF250	2 1/2	0.94	36
ABF300	3	1.66	24
ABF400	4	2.72	20
ABF600	6	5.26	8

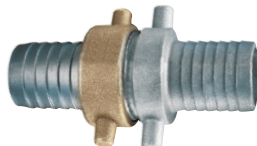

Aluminum Shank with Brass Swivel Nut Complete Set (NST Threads)

Part Number	Size (in.)	Weight Each (lbs.)	Standard Carton
FHNST150	1 1/2	0.43	40
FHNST250	2 1/2	1.04	12



Aluminum Shank with Brass Swivel Nut Female (NST Threads)

Part Number	Size (in.)	Weight Each (lbs.)	Standard Carton
FHNST-F150	1 1/2	0.29	150
FHNST-F250	2 1/2	0.70	36

NEW



Aluminum Shank Male End (NST Threads)

Part Number	Size (in.)	Weight Each (lbs.)	Standard Carton
FHNST-M150	1 1/2	0.14	150
FHNST-M250	2 1/2	0.34	36

PSI Rating @ 70°F (+21°C)

1/2" – 2"	75 PSI
2 1/2" – 4"	50 PSI
6"	25 PSI

Because we continually examine ways to improve our products, we reserve the right to alter specifications or discontinue products without prior notice.



Ground Joint Couplings

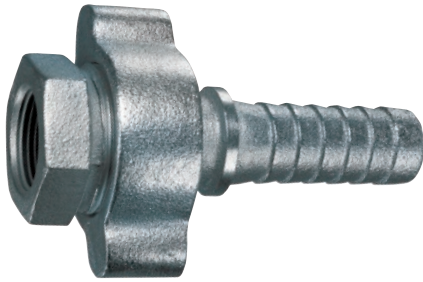

**Hose Stem with Wing Nut and Female NPT Spud
(Complete Set Consisting of GJS, GJN, GJF)**

Part Number	Size (in.)	Weight Each (lbs.)	Standard Carton
GJ-050	1/2	0.75	50
GJ-075	3/4	1.86	25
GJ-100	1	1.81	30
GJ-125	1 1/4	3.73	15
GJ-150	1 1/2	3.68	15
GJ-200	2	5.69	10
GJ-250	2 1/2	12.59	4
GJ-300	3	15.85	4
GJ-400	4	28.46	2



Wing Nut (NPS Threads)

Part Number	Size (in.)	Weight Each (lbs.)	Standard Carton
GJN-050	1/2	0.31	200
GJN-075	3/4	0.71	60
GJN-100	1	0.71	60
GJN-125	1 1/4	1.52	40
GJN-150	1 1/2	1.52	40
GJN-200	2	2.54	24
GJN-250	2 1/2	4.65	10
GJN-300	3	5.51	10
GJN-400	4	10.63	4



Hose Stem

Part Number	Size (in.)	Weight Each (lbs.)	Standard Carton
GJS-050	1/2	0.18	200
GJS-075	3/4	0.55	100
GJS-100	1	0.81	100
GJS-125	1 1/4	1.17	32
GJS-150	1 1/2	1.30	35
GJS-200	2	1.72	25
GJS-250	2 1/2	3.70	10
GJS-300	3	4.83	8
GJS-400	4	8.95	4



**Female Spud with Copper Seal
(Female NPT x Male NPS)**

Part Number	Size (in.)	Weight Each (lbs.)	Standard Carton
GJF-050	1/2	0.29	200
GJF-075	3/4	0.64	100
GJF-100	1	0.57	100
GJF-125	1 1/4	1.21	40
GJF-150	1 1/2	1.04	40
GJF-200	2	1.39	32
GJF-250	2 1/2	4.23	12
GJF-300	3	5.51	10
GJF-400	4	8.88	5

Because we continually examine ways to improve our products, we reserve the right to alter specifications or discontinue products without prior notice.

Ground Joint Couplings



**Male Spud with Copper Seal
(Male NPT x Male NPS)**

Part Number	Size (in.)	Weight Each (lbs.)	Standard Carton
GMS-050	1/2	0.29	100
GMS-075	3/4	0.75	60
GMS-100	1	0.79	50
GMS-125	1 1/4	1.43	30
GMS-150	1 1/2	1.70	30
GMS-200	2	2.23	30



**Double Spud with Copper Seal
(Male NPS x Male NPS)**

Part Number	Size (in.)	Weight Each (lbs.)	Standard Carton
GDS-050	1/2	0.40	100
GDS-075	3/4	1.32	60
GDS-100	1	1.32	50
GDS-125	1 1/4	1.41	30
GDS-150	1 1/2	1.41	30
GDS-200	2	1.92	24

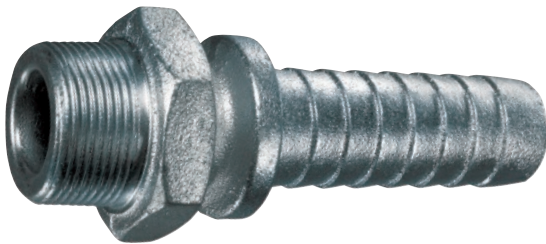

**Threaded Male Hose Shank
(Male NPT x Hose Shank)**

Part Number	Size (in.)	Weight Each (lbs.)	Standard Carton
GJM-050	1/2	0.17	250
GJM-075	3/4	0.33	250
GJM-100	1	0.55	100
GJM-125	1 1/4	1.28	32
GJM-150	1 1/2	1.79	25
GJM-200	2	2.65	20
GJM-250	2 1/2	4.83	8
GJM-300	3	6.26	6
GJM-400	4	11.40	3

Specifications

PSI Rating

Steam	250 PSI
Air	600 PSI

Temperature 450°F (+232°C)

Interlocking Bolt Clamps recommended when assembling to a hose.

Because we continually examine ways to improve our products, we reserve the right to alter specifications or discontinue products without prior notice.



Sandblast Couplings

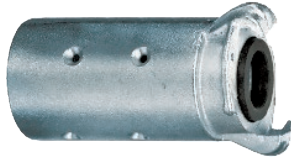

Aluminum Two Lug Hose Coupling

Part Number	Hose Size (in.)	Hose OD (in.)	Weight Each (lbs.)	Standard Carton
Q-AL050	1/2	1.06	0.15	6
Q-AL1	3/4	1 1/2	0.36	6
Q-AL2	1	1 7/8	0.36	6
Q-AL3	1 1/4	2 5/32	0.66	6
Q-AL4	1 1/2	2 3/8	0.88	6
†Q-AL5	1 1/2	2 3/8	1.10	6

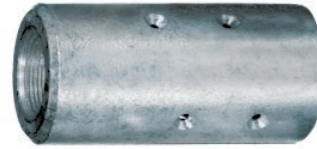

Aluminum Nozzle Holder (NPS Threads)

Part Number	Hose Size (in.)	Hose OD (in.)	NPS Thread Size (in.)	Weight Each (lbs.)	Standard Carton
NH-AL050	1/2	1.06	3/4	0.15	6
NH-AL1	3/4	1 1/2	1 1/4	0.30	6
NH-AL2	1	1 7/8	1 1/4	0.36	6
NH-AL3	1 1/4	2 5/32	1 1/4	0.52	6
NH-AL4	1 1/2	2 3/8	1 1/4	0.98	6

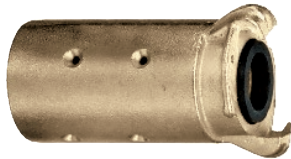

Brass Two Lug Hose Coupling

Part Number	Hose Size (in.)	Hose OD (in.)	Weight Each (lbs.)	Standard Carton
Q-BR1	3/4	1 1/2	1.06	6
Q-BR2	1	1 7/8	1.12	6
Q-BR3	1 1/4	2 5/32	1.94	6
Q-BR4	1 1/2	2 3/8	2.64	6
†Q-BR5	1 1/2	2 3/8	3.50	6

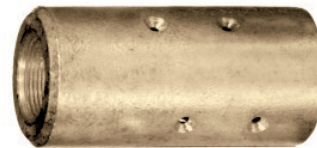

Brass Nozzle Holder (NPS Threads)

Part Number	Hose Size (in.)	Hose OD (in.)	NPS Thread Size (in.)	Weight Each (lbs.)	Standard Carton
NH-BR1	3/4	1 1/2	1 1/4	0.94	6
NH-BR2	1	1 7/8	1 1/4	1.02	6
NH-BR3	1 1/4	2 5/32	1 1/4	1.58	6
NH-BR4	1 1/2	2 3/8	1 1/4	2.96	6

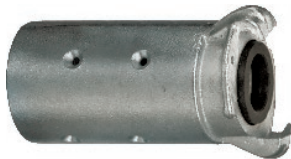

Plated Iron Two Lug Hose Coupling

Part Number	Hose Size (in.)	Hose OD (in.)	Weight Each (lbs.)	Standard Carton
Q-PI1	3/4	1 1/2	0.98	10
Q-PI2	1	1 7/8	1.02	10
Q-PI3	1 1/4	2 5/32	1.84	10
Q-PI4	1 1/2	2 3/8	2.38	10



Aluminum Two Lug Female Threaded Coupling (NPT Threads)

Part Number	Hose Size (in.)	NPT Thread (in.)	Weight Each (lbs.)	Standard Carton
SB-AL1	1 1/4	1 1/4	0.34	6
SB-AL2	1 1/2	1 1/2	0.28	6
†SB-AL3	1 1/2	1 1/2	1.05	6



Brass Two Lug Female Threaded Coupling (NPT Threads)

Part Number	Hose Size (in.)	NPT Thread (in.)	Weight Each (lbs.)	Standard Carton
SB-BR1	1 1/4	1 1/4	1.02	6
SB-BR2	1 1/2	1 1/2	0.84	6
†SB-BR3	1 1/2	1 1/2	3.05	6

Specifications

PSI Rating @ 70°F (+21°C)

All Sizes Brass 175 PSI

All Sizes Aluminum 150 PSI

†**Note:** Q-AL5, Q-BR5, SB-AL3 and SB-BR3 are large ID full flow fittings for 1 1/2" ID hose and are not interchangeable with the standard fittings.

Because we continually examine ways to improve our products, we reserve the right to alter specifications or discontinue products without prior notice.



Universal Air Hose Couplings



Zinc Plated Two Lug Hose Coupling

Part Number	Size (in.)	Weight Each (lbs.)	Standard Carton
HE-38	3/8	0.44	25
HE-50	1/2	0.48	25
HE-75	3/4	0.56	25
HE-100	1	0.64	25



Zinc Plated Two Lug Hose Coupling with Crimp Ferrule

Part Number	Size (in.)	Hose OD (in.)	Weight Each (lbs.)	Standard Carton
FHE-50	1/2	27/32 - 1 1/32	0.50	20
FHE-75	3/4	1 1/16 - 1 11/32	0.60	20
FHE-100	1	1 9/32 - 1 17/32	0.66	20
FHE-101	1	1 15/32 - 1 23/32	0.66	20

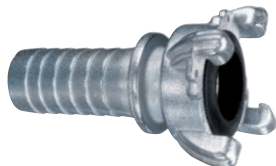

Zinc Plated Four Lug Hose Coupling

Part Number	Size (in.)	Weight Each (lbs.)	Standard Carton
HE-125	1 1/4	1.70	10
HE-150	1 1/2	1.80	10
HE-200	2	2.00	10



Zinc Plated Two Lug Male Threaded Coupling (NPT Threads)

Part Number	Size (in.)	Weight Each (lbs.)	Standard Carton
ME-25	1/4	0.36	25
ME-38	3/8	0.40	25
ME-50	1/2	0.44	25
ME-75	3/4	0.48	25
ME-100	1	0.60	25



Zinc Plated Two Lug Female Threaded Coupling (NPT Threads)

Part Number	Size (in.)	Weight Each (lbs.)	Standard Carton
FE-25	1/4	0.32	25
FE-38	3/8	0.33	25
FE-50	1/2	0.44	25
FE-75	3/4	0.48	25
FE-100	1	0.52	25



Zinc Plated Four Lug Female Threaded Coupling (NPT Threads)

Part Number	Size (in.)	Weight Each (lbs.)	Standard Carton
FE-125	1 1/4	0.90	10
FE-150	1 1/2	1.00	10
FE-200	2	1.20	10



Zinc Plated Three Way Connector

Part Number	Weight Each (lbs.)	Standard Carton
TWC	0.90	12



Zinc Plated Blank End

Part Number	Weight Each (lbs.)	Standard Carton
BE	0.52	25

PSI Rating @ 70°F (+21°C)

1/4" – 2"

150 PSI

Because we continually examine ways to improve our products, we reserve the right to alter specifications or discontinue products without prior notice.



Kuri-Clamp™ Center Punch Clamps

Features & Benefits:

- Doubled wrapped for secure holding ability
- Compatible with most pneumatic equipment or hand operated tools
- Available in both carbon steel & 201 stainless steel



Carbon Steel

201 Stainless Steel

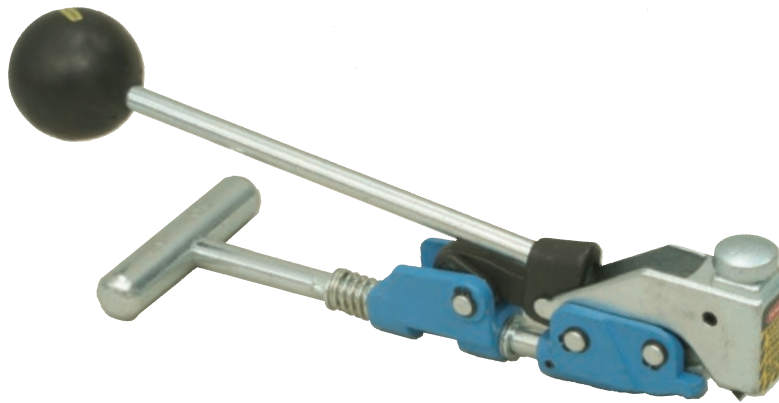

Kuri-Clamp™ Center Punch Clamp Tool

Part Number	Description	Weight Each (lbs.)	Standard Box
CPT300	Center Punch Tool	3.00	1
CPA032	Replacement Adapter	0.14	1

The center punch tool will work with both 3/8" and 5/8" wide clamps. The CPA032 adapter is required to assemble the 3/8" wide clamps. This adapter is provided with the CPT300 tool and also sold separately.

Because we continually examine ways to improve our products, we reserve the right to alter specifications or discontinue products without prior notice.



Kuri-Clamp™ Center Punch Clamps



Galvanized Carbon Steel Center Punch Clamp

Part Number	Size (in.)	Pieces Per Box	Band Width (in.)	Weight Per Box (lbs.)	Standard Box
CPCS03	13/16	100	3/8	3.60	1
CPCS31	1 3/8	100	3/8	4.60	1
CPCS04	1	100	5/8	8.30	1
CPCS05	1 1/4	100	5/8	8.70	1
CPCS06	1 1/2	100	5/8	9.70	1
CPCS07	1 3/4	100	5/8	10.60	1
CPCS08	2	100	5/8	11.50	1
CPCS09	2 1/4	100	5/8	12.60	1
CPCS10	2 1/2	50	5/8	6.80	1
CPCS11	2 3/4	50	5/8	7.30	1
CPCS12	3	50	5/8	7.70	1
CPCS14	3 1/2	50	5/8	8.70	1
CPCS16	4	25	5/8	4.90	1
CPCS18	4 1/2	25	5/8	5.50	1
CPCS20	5	25	5/8	5.90	1
CPCS24	6	25	5/8	6.80	1
CPCS26	6 1/2	25	5/8	7.10	1
CPCS28	7	25	5/8	7.40	1
CPCS32	8	25	5/8	8.20	1

*Clamps are sold in box quantities only.

201 Stainless Steel Center Punch Clamp

Part Number	Size (in.)	Pieces Per Box	Band Width (in.)	Weight Per Box (lbs.)	Standard Box
CPSS03	13/16	100	3/8	3.60	1
CPSS31	1 3/8	100	3/8	4.60	1
CPSS04	1	100	5/8	8.30	1
CPSS05	1 1/4	100	5/8	8.70	1
CPSS06	1 1/2	100	5/8	9.70	1
CPSS07	1 3/4	100	5/8	10.60	1
CPSS08	2	100	5/8	11.50	1
CPSS09	2 1/4	100	5/8	12.60	1
CPSS10	2 1/2	50	5/8	6.80	1
CPSS11	2 3/4	50	5/8	7.30	1
CPSS12	3	50	5/8	7.70	1
CPSS14	3 1/2	50	5/8	8.70	1
CPSS16	4	25	5/8	4.90	1
CPSS18	4 1/2	25	5/8	5.50	1
CPSS20	5	25	5/8	5.90	1
CPSS24	6	25	5/8	6.80	1
CPSS26	6 1/2	25	5/8	7.10	1
CPSS28	7	25	5/8	7.40	1
CPSS32	8	25	5/8	8.20	1

*Clamps are sold in box quantities only.

Because we continually examine ways to improve our products, we reserve the right to alter specifications or discontinue products without prior notice.



NEW
SIZES

Tiger Clamp™ Spiral Double Bolt Clamps



**Zinc Plated Carbon Steel Spiral Double Bolt Clamp (For Counterclockwise Spiral Hoses)
Designed for Tigerflex™ PVC Suction Hoses**

**Stainless Steel 304 Spiral Double Bolt Clamp (For Counterclockwise Spiral Hoses)
Designed for Tigerflex™ PVC Suction Hoses**

Part Number	Size (in.)	Torque (ft. lbs.)	Weight Each (lbs.)	Standard Carton
SDBC-1.5	1 1/2	6	0.18	100
SDBC-2	2	6	0.36	100
SDBC-2.25	2 1/4	6	0.40	100
SDBC-2.5	2 1/2	8	0.48	100
SDBC-3	3	8	0.66	70
SDBC-3.5	3 1/2	8	0.70	70
SDBC-4	4	24	1.02	40
SDBC-5	5	24	1.76	30
SDBC-6	6	30	2.00	20
SDBC-8	8	30	2.76	10
SDBC-10	10	30	3.46	10
SDBC-12	12	30	4.14	10

Part Number	Size (in.)	Torque (ft. lbs.)	Weight Each (lbs.)	Standard Carton
SDBC-SS-1.5	1 1/2	6	0.20	100
SDBC-SS-2	2	6	0.40	100
SDBC-SS-2.5	2 1/2	8	0.53	100
SDBC-SS-3	3	8	0.73	70
SDBC-SS-3.5	3 1/2	8	0.77	70
SDBC-SS-4	4	24	1.12	40
SDBC-SS-5	5	24	1.94	30
SDBC-SS-6	6	30	2.20	20
SDBC-SS-8	8	30	3.04	10
SDBC-SS-10	10	30	3.81	10
SDBC-SS-12	12	30	4.55	10



**Zinc Plated Carbon Steel Spiral Double Bolt Clamp (For Clockwise Spiral Hoses)
Designed for Tigerflex™ Tiger-TR1™ Hoses**

Part Number	Size (in.)	Torque (ft. lbs.)	Weight Each (lbs.)	Standard Carton
SDBCR-1.5	1 1/2	6	0.18	100
SDBCR-2	2	6	0.36	100
SDBCR-3	3	8	0.66	70
SDBCR-4	4	24	1.02	40
SDBCR-5	5	24	1.76	30
SDBCR-6	6	30	2.00	20
SDBCR-8	8	30	2.76	10
SDBCR-10	10	30	3.46	10
SDBCR-12	12	30	4.14	10

Because we continually examine ways to improve our products, we reserve the right to alter specifications or discontinue products without prior notice.



Ducting-Bridge Clamps/Double Bolt Clamps



**Bridge Clamp for Ducting Hoses
300 Stainless Worm Gear Band
(For Counterclockwise Spiral Hoses)**

Part Number	Size (in.)	Size Range (in.)	Weight Each (lbs.)	Standard Carton
DCLPL250	2 1/2	2 3/8 - 2 3/4	0.086	200
DCLPL300	3	2 7/8 - 3 3/8	0.093	200
DCLPL400	4	3 1/2 - 4 1/2	0.130	200
DCLPL500	5	4 3/8 - 5 1/4	0.143	200
DCLPL600	6	5 1/4 - 6 1/4	0.167	200
DCLPL700	7	6 1/4 - 7 1/4	0.175	200
DCLPL800	8	7 3/8 - 8 3/8	0.207	100
DCLPL1000	10	9 1/4 - 10 1/4	0.242	100
DCLPL1200	12	11 1/4 - 12 1/4	0.284	100



**Bridge Clamp for Ducting Hoses
300 Stainless Worm Gear Band
(For Clockwise Spiral Hoses)**

Part Number	Size (in.)	Size Range (in.)	Weight Each (lbs.)	Standard Carton
DCLPR250	2 1/2	2 3/8 - 2 3/4	0.086	200
DCLPR300	3	2 7/8 - 3 3/8	0.093	200
DCLPR400	4	3 1/2 - 4 1/2	0.130	200
DCLPR500	5	4 3/8 - 5 1/4	0.143	200
DCLPR600	6	5 1/4 - 6 1/4	0.167	200
DCLPR700	7	6 1/4 - 7 1/4	0.175	200
DCLPR800	8	7 3/8 - 8 3/8	0.207	100
DCLPR1000	10	9 1/4 - 10 1/4	0.242	100
DCLPR1200	12	11 1/4 - 12 1/4	0.284	100



Zinc Plated Ductile Iron Double Bolt Hose Clamp

Part Number	Size Range (in.)	Torque (ft. lbs.)	Weight Each (lbs.)	Standard Carton
DB29	7/8 - 1 9/64	20	0.29	200
DB34	1 5/32 - 1 11/32	20	0.31	200
DB40	1 5/16 - 1 19/32	20	0.43	100
DB49	1 5/8 - 1 15/16	20	0.56	100
DB60	1 7/8 - 2 3/8	20	0.64	60
DB76	2 3/8 - 3 1/64	40	0.73	60
DB94	3 1/32 - 3 11/16	40	1.30	40
DB400	3 1/2 - 4	40	1.54	30
DB463	4 1/16 - 4 7/16	40	1.79	30
DB525	4 3/16 - 5	60	2.14	20
DB550	5 - 5 1/2	60	2.27	20
DB600	5 1/2 - 6 1/16	60	2.65	20
DB675	6 1/8 - 6 7/8	60	2.98	20
DB769	6 15/16 - 7 5/8	60	3.81	10
DB818	7 11/16 - 8 3/16	125	5.11	10
DB875	8 1/4 - 8 7/8	125	5.64	10
DB988	8 15/16 - 9 7/8	125	6.15	10
DB1125	9 15/16 - 11 3/8	125	9.48	4
DB1275	11 3/16 - 12 1/2	125	9.61	4
DB1360	12 3/16 - 14	200	15.43	3

Because we continually examine ways to improve our products, we reserve the right to alter specifications or discontinue products without prior notice.



T-Bolt Clamps



Heavy Duty T-Bolt Clamp 304 Stainless Steel Band, Bolt and Nut

Part Number	Size Range (in.)	Band Width (in.)	Torque (ft. lbs.)	Weight Each (lbs.)	Standard Carton
TBC-SS019	21/32 - 3/4	23/32	6	0.064	500
TBC-SS022	25/32 - 7/8	23/32	6	0.066	500
TBC-SS025	29/32 - 1	23/32	6	0.068	500
TBC-SS028	1 1/32 - 1 3/32	23/32	6	0.068	500
TBC-SS031	1 5/32 - 1 5/16	25/32	7	0.115	500
TBC-SS035	1 1/4 - 1 3/8	25/32	7	0.115	500
TBC-SS039	1 3/8 - 1 9/16	25/32	7	0.117	500
TBC-SS043	1 5/8 - 1 13/16	25/32	7	0.121	500
TBC-SS047	1 3/4 - 1 15/16	7/8	10	0.198	200
TBC-SS051	1 7/8 - 2 1/16	7/8	10	0.209	200
TBC-SS055	2 1/8 - 2 5/16	7/8	10	0.216	200
TBC-SS059	2 1/4 - 2 7/16	7/8	10	0.221	200
TBC-SS063	2 3/8 - 2 9/16	7/8	10	0.227	200
TBC-SS067	2 17/32 - 2 13/16	7/8	10	0.232	200
TBC-SS073	2 21/32 - 2 15/16	15/16	17	0.331	100
TBC-SS079	2 29/32 - 3 3/16	15/16	17	0.353	100
TBC-SS085	3 1/32 - 3 5/16	15/16	17	0.353	100
TBC-SS091	3 9/32 - 3 9/16	15/16	17	0.364	100
TBC-SS097	3 17/32 - 3 13/16	15/16	17	0.397	100
TBC-SS103	3 25/32 - 4 1/16	15/16	17	0.397	100
TBC-SS112	4 1/32 - 4 5/16	15/16	17	0.419	100
TBC-SS121	4 17/32 - 4 13/16	15/16	17	0.430	100
TBC-SS130	4 25/32 - 5 1/16	15/16	17	0.441	100
TBC-SS139	5 9/32 - 5 9/16	1 1/32	29	0.644	60
TBC-SS148	5 17/32 - 5 13/16	1 1/32	29	0.679	60
TBC-SS161	5 7/8 - 6 11/32	1 1/32	29	0.703	80
TBC-SS174	6 17/32 - 6 13/16	1 1/32	29	0.723	80
TBC-SS187	6 7/8 - 7 3/8	1 1/32	29	0.750	60
TBC-SS200	7 13/32 - 7 7/8	1 1/32	29	0.787	60
TBC-SS213	7 29/32 - 8 3/8	1 1/32	29	0.809	60
TBC-SS226	8 21/32 - 8 15/16	1 1/32	29	0.844	60
TBC-SS239	8 15/16 - 9 13/32	1 1/32	29	0.882	60
TBC-SS252	9 7/16 - 9 29/32	1 1/32	29	0.919	60

Because we continually examine ways to improve our products, we reserve the right to alter specifications or discontinue products without prior notice.



T-Bolt Clamps



Heavy Duty T-Bolt Clamp 304 Stainless Steel Band, Carbon Steel Bolt and Nut

Part Number	Size Range (in.)	Band Width (in.)	Torque (ft. lbs.)	Weight Each (lbs.)	Standard Carton
TBC-SSC019	21/32 - 3/4	23/32	6	0.064	500
TBC-SSC022	25/32 - 7/8	23/32	6	0.066	500
TBC-SSC025	29/32 - 1	23/32	6	0.068	500
TBC-SSC028	1 1/32 - 1 3/32	23/32	6	0.068	500
TBC-SSC031	1 5/32 - 1 5/16	25/32	7	0.115	500
TBC-SSC035	1 1/4 - 1 3/8	25/32	7	0.115	500
TBC-SSC039	1 3/8 - 1 9/16	25/32	7	0.117	500
TBC-SSC043	1 5/8 - 1 13/16	25/32	7	0.121	500
TBC-SSC047	1 3/4 - 1 15/16	7/8	10	0.198	200
TBC-SSC051	1 7/8 - 2 1/16	7/8	10	0.209	200
TBC-SSC055	2 1/8 - 2 5/16	7/8	10	0.216	200
TBC-SSC059	2 1/4 - 2 7/16	7/8	10	0.221	200
TBC-SSC063	2 3/8 - 2 9/16	7/8	10	0.227	200
TBC-SSC067	2 17/32 - 2 13/16	7/8	10	0.232	200
TBC-SSC073	2 21/32 - 2 15/16	15/16	17	0.331	100
TBC-SSC079	2 29/32 - 3 3/16	15/16	17	0.353	100
TBC-SSC085	3 1/32 - 3 5/16	15/16	17	0.353	100
TBC-SSC091	3 9/32 - 3 9/16	15/16	17	0.364	100
TBC-SSC097	3 17/32 - 3 13/16	15/16	17	0.397	100
TBC-SSC103	3 25/32 - 4 1/16	15/16	17	0.397	100
TBC-SSC112	4 1/32 - 4 5/16	15/16	17	0.419	100
TBC-SSC121	4 17/32 - 4 13/16	15/16	17	0.430	100
TBC-SSC130	4 25/32 - 5 1/16	15/16	17	0.441	100
TBC-SSC139	5 9/32 - 5 9/16	1 1/32	29	0.644	60
TBC-SSC148	5 17/32 - 5 13/16	1 1/32	29	0.679	60
TBC-SSC161	5 7/8 - 6 11/32	1 1/32	29	0.703	80
TBC-SSC174	6 17/32 - 6 13/16	1 1/32	29	0.723	80
TBC-SSC187	6 7/8 - 7 3/8	1 1/32	29	0.750	60
TBC-SSC200	7 13/32 - 7 7/8	1 1/32	29	0.787	60
TBC-SSC213	7 29/32 - 8 3/8	1 1/32	29	0.809	60
TBC-SSC226	8 21/32 - 8 15/16	1 1/32	29	0.844	60
TBC-SSC239	8 15/16 - 9 13/32	1 1/32	29	0.882	60
TBC-SSC252	9 7/16 - 9 29/32	1 1/32	29	0.919	60

Because we continually examine ways to improve our products, we reserve the right to alter specifications or discontinue products without prior notice.



Interlocking Bolt Clamps



2 Bolt Hose Clamp

(Recommended for use with Universal Couplings)

Part Number	Size Range (in.)	Weight Each (lbs.)	Torque (ft. lbs.)	Standard Carton
HC-50	1 - 1 1/8	0.32	6	25
HC-75	1 1/8 - 1 5/16	0.56	12	25
HC-100	1 17/32 - 1 21/32	0.72	21	25

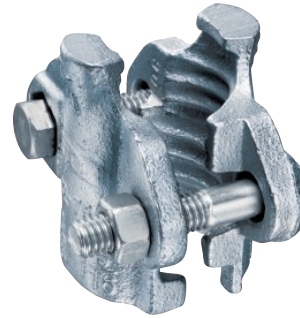

2 Bolt Hose Clamp

(Recommended for use with Ground Joint Couplings)

Part Number	Size Range (in.)	Weight Each (lbs.)	Torque (ft. lbs.)	Standard Carton
BC2-050	13/16 - 15/16	0.31	6	100
BC2-050A	15/16 - 1 1/16	0.44	12	100
BC2-050B	1 1/16 - 1 3/16	0.48	12	100
BC2-075	1 5/32 - 1 9/32	0.73	21	60
BC2-075A	1 3/16 - 1 5/16	0.79	21	60
BC2-075B	1 5/16 - 1 1/2	0.88	21	60
BC2-075C	1 1/2 - 1 11/16	1.15	21	40



4 Bolt Hose Clamp

(Recommended for use with Ground Joint Couplings)

Part Number	Size Range (in.)	Weight Each (lbs.)	Torque (ft. lbs.)	Standard Carton
BC4-100	1 17/32 - 1 23/32	1.50	21	24
BC4-100A	1 13/32 - 1 9/16	1.54	21	24
BC4-100B	1 11/16 - 1 27/32	1.68	21	24
BC4-100C	1 7/8 - 2 1/16	1.90	21	20
BC4-125	2 1/16 - 2 1/4	2.36	40	20
BC4-150	2 - 2 17/32	2.40	40	20
BC4-150A	2 3/32 - 2 9/32	2.56	40	20
BC4-150B	2 1/4 - 2 7/16	2.78	40	20
BC4-150C	2 15/32 - 2 23/32	2.67	40	20
BC4-200	2 11/32 - 2 17/32	3.04	60	20
BC4-200A	2 1/2 - 2 25/32	2.84	60	20
BC4-200B	2 3/4 - 3 1/16	3.99	60	16
BC4-200C	3 3/32 - 3 7/16	3.97	60	14
BC4-250	3 1/2 - 3 15/16	6.86	150	5
BC4-300	3 1/2 - 3 15/16	7.45	150	5
BC4-300A	3 13/16 - 4 1/16	7.89	150	5
BC4-300B	4 1/16 - 4 7/16	10.19	200	4
BC4-300C	4 1/4 - 4 13/16	10.30	200	4

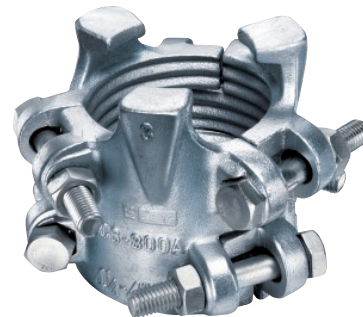

6 Bolt Hose Clamp

(Recommended for use with Ground Joint Couplings)

Part Number	Size Range (in.)	Weight Each (lbs.)	Torque (ft. lbs.)	Standard Carton
BC6-300A	4 1/4 - 4 13/16	12.32	150	4
BC6-400A	4 7/8 - 5 5/16	20.30	200	2
BC6-400B	5 1/8 - 6 3/16	21.45	200	2

Because we continually examine ways to improve our products, we reserve the right to alter specifications or discontinue products without prior notice.



Kuri-Krimp™ Crimp Sleeves

*** NEW SIZES**

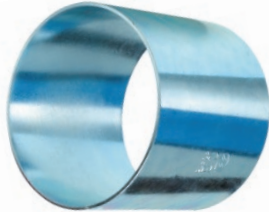

Kuri-Krimp™ Plated Steel Crimp Sleeve

Part Number	Hose ID (in.)	Sleeve ID (in.)	Wall Thickness (in.)	Length (in.)	Weight Each (lbs.)	Standard Carton
CRS-CS10108	1	1.50	0.059	2.29	0.19	200
CRS-CS10109	1	1.56	0.059	2.29	0.20	200
CRS-CS15200	1 1/2	2.00	0.059	2.36	0.25	128
CRS-CS15202	1 1/2	2.12	0.059	2.36	0.26	128
CRS-CS20209	2	2.56	0.059	2.79	0.37	80
CRS-CS20210	2	2.62	0.059	2.79	0.40	80
CRS-CS20211	2	2.68	0.059	2.79	0.40	80
CRS-CS25302	2 1/2	3.12	0.059	3.11	0.52	60
CRS-CS25304	2 1/2	3.25	0.059	3.11	0.54	60
CRS-CS30310	3	3.62	0.091	3.94	1.19	40
CRS-CS30312	3	3.75	0.091	3.94	1.21	40
CRS-CS30313	3	3.81	0.091	3.94	1.23	40
CRS-CS30400	3	4.00	0.091	3.94	1.30	40
CRS-CS40411	4	4.68	0.091	4.19	1.61	30
CRS-CS40412	4	4.75	0.091	4.19	1.63	30
CRS-CS40413	4	4.81	0.091	4.19	1.65	30
CRS-CS40500	4	5.00	0.091	4.19	1.72	30
CRS-CS60610	6	6.63	0.118	5.67	4.02	8
CRS-CS60612	6	6.75	0.118	5.67	4.10	8
CRS-CS60614	6	6.88	0.118	5.67	4.17	8
CRS-CS60700	6	7.00	0.118	5.67	4.24	8
CRS-CS60704	6	7.25	0.118	5.67	4.39	8
CRS-CS60706	6	7.38	0.118	5.67	4.47	8
CRS-CS80812	8	8.75	0.118	6.50	6.06	8
CRS-CS80814	8	8.88	0.118	6.50	6.15	8
CRS-CS80900	8	9.00	0.118	6.50	6.23	8
CRS-CS80902	8	9.13	0.118	6.50	6.32	8
CRS-CS80904	8	9.25	0.118	6.50	6.41	8
CRS-CS80908	8	9.50	0.118	6.50	6.58	8
* CRS-CS1001012	10	10.75	0.120	6.50	7.42	2
* CRS-CS1001100	10	11.00	0.120	6.50	7.60	2
* CRS-CS1001104	10	11.25	0.120	6.50	7.78	2
* CRS-CS1201212	12	12.75	0.120	9.00	12.18	1
* CRS-CS1201300	12	13.00	0.120	9.00	12.40	1
* CRS-CS1201304	12	13.25	0.120	9.00	12.64	1

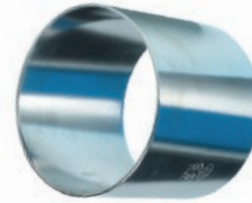

Kuri-Krimp™ 304 Stainless Steel Crimp Sleeve

Part Number	Hose ID (in.)	Sleeve ID (in.)	Wall Thickness (in.)	Length (in.)	Weight Each (lbs.)	Standard Carton
CRS-SS10108	1	1.50	0.059	2.29	0.20	200
CRS-SS10109	1	1.56	0.059	2.29	0.21	200
CRS-SS15200	1 1/2	2.00	0.059	2.36	0.27	128
CRS-SS15202	1 1/2	2.12	0.059	2.36	0.29	128
CRS-SS20209	2	2.56	0.059	2.79	0.40	80
CRS-SS20210	2	2.62	0.059	2.79	0.43	80
CRS-SS20211	2	2.68	0.059	2.79	0.43	80
CRS-SS25302	2 1/2	3.12	0.059	3.11	0.56	60
CRS-SS25304	2 1/2	3.25	0.059	3.11	0.58	60
CRS-SS30310	3	3.62	0.098	3.94	1.29	40
CRS-SS30312	3	3.75	0.098	3.94	1.31	40
CRS-SS30313	3	3.81	0.098	3.94	1.33	40
CRS-SS30400	3	4.00	0.098	3.94	1.40	40
CRS-SS40411	4	4.68	0.098	4.19	1.74	30
CRS-SS40412	4	4.75	0.098	4.19	1.76	30
CRS-SS40413	4	4.81	0.098	4.19	1.78	30
CRS-SS40500	4	5.00	0.098	4.19	1.86	30

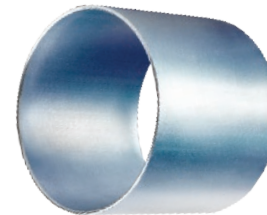

Kuri-Krimp™ Aluminum Crimp Sleeve

Part Number	Hose ID (in.)	Sleeve ID (in.)	Wall Thickness (in.)	Length (in.)	Weight Each (lbs.)	Standard Carton
CRS-AL20209	2	2.56	0.079	2.79	0.18	100
CRS-AL20210	2	2.63	0.079	2.79	0.18	100
CRS-AL20211	2	2.69	0.079	2.79	0.19	100
CRS-AL30310	3	3.63	0.079	3.94	0.35	36
CRS-AL30312	3	3.75	0.079	3.94	0.36	36
CRS-AL30313	3	3.81	0.079	3.94	0.37	36
CRS-AL30400	3	4.00	0.079	3.94	0.39	36
CRS-AL40411	4	4.69	0.098	4.19	0.60	36
CRS-AL40412	4	4.75	0.098	4.19	0.61	36
CRS-AL40413	4	4.81	0.098	4.19	0.62	36
CRS-AL40500	4	5.00	0.098	4.19	0.64	36

Because we continually examine ways to improve our products, we reserve the right to alter specifications or discontinue products without prior notice.



Hydrant & Garden Hose Wrenches / Fittings / Adapters



Female to Male Hex Nipple

Part Number	Size (in.)	Weight Each (lbs.)	Standard Carton
FMHN-12GH16PT	3/4 GHT x 1 NPT	0.25	200
FMHN-16PT12GH	1 NPT x 3/4 GHT	0.26	100
FMHN-24PT24SH	1 1/2 NPT x 1 1/2 NPSH	0.51	100
FMHN-40PT40SH	2 1/2 NPT x 2 1/2 NPSH	1.33	20
FMHN-24PT24ST	1 1/2 NPT x 1 1/2 NST	0.53	100
FMHN-40PT40ST	2 1/2 NPT x 2 1/2 NST	1.20	25
FMHN-48PT40ST	3 NPT x 2 1/2 NST	2.92	20
FMHN-16SH12GH	1 NPSH x 3/4 GHT	0.25	100
FMHN-24SH24PT	1 1/2 NPSH x 1 1/2 NPT	0.49	100
FMHN-24SH24ST	1 1/2 NPSH x 1 1/2 NST	0.55	100
FMHN-40SH40ST	2 1/2 NPSH x 2 1/2 NST	1.20	25
FMHN-24ST24PT	1 1/2 NST x 1 1/2 NPT	0.44	100
FMHN-24ST24SH	1 1/2 NST x 1 1/2 NPSH	0.49	100
FMHN-40ST32PT	2 1/2 NST x 2 NPT	2.29	30
FMHN-40ST40PT	2 1/2 NST x 2 1/2 NPT	1.76	20
FMHN-40ST48PT	2 1/2 NST x 3 NPT	2.43	20
FMHN-40ST40SH	2 1/2 NST x 2 1/2 NPSH	1.59	20
FMHN-40ST48ST	2 1/2 NST x 3 NST	2.43	20
FMHN-48ST40ST	3 NST x 2 1/2 NST	2.87	20



Brass Hydrant Adapter

Part Number	Size (in.)	Weight Each (lbs.)	Standard Carton
BHYA-24ST12GH	1 1/2 NST x 3/4 GHT	0.52	100
BHYA-40ST12GH	2 1/2 NST x 3/4 GHT	1.16	50
BHYA-40ST16SH	2 1/2 NST x 1 NPSH	1.03	50
BHYA-40ST24SH	2 1/2 NST x 1 1/2 NPSH	1.00	40
BHYA-40ST32SH	2 1/2 NST x 2 NPSH	1.07	40
BHYA-24ST24PT	1 1/2 NST x 1 1/2 NPT	0.60	100
BHYA-40ST12PT	2 1/2 NST x 3/4 NPT	0.90	50
BHYA-40ST16PT	2 1/2 NST x 1 NPT	1.02	50
BHYA-40ST24PT	2 1/2 NST x 1 1/2 NPT	0.91	40
BHYA-40ST32PT	2 1/2 NST x 2 NPT	1.11	40
BHYA-40ST24ST	2 1/2 NST x 1 1/2 NST	0.98	40
BHYA-48ST40ST	3 NST x 2 1/2 NST	1.72	20
BHYA-24SH24ST	1 1/2 NPSH x 1 1/2 NST	0.60	100
BHYA-48SH40ST	3 NPSH x 2 1/2 NST	1.42	20
BHYA-24SH24PT	1 1/2 NPSH x 1 1/2 NPT	0.60	100



Double Male Hex Nipple

Part Number	Size (in.)	Weight Each (lbs.)	Standard Carton
DMHN-16PT12GH	1 NPT x 3/4 GHT	0.26	200
DMHN-16PT16SH	1 NPT x 1 NPSH	0.33	100
DMHN-24PT24SH	1 1/2 NPT x 1 1/2 NPSH	0.52	100
DMHN-32PT32SH	2 NPT x 2 NPSH	1.25	50
DMHN-40PT40SH	2 1/2 NPT x 2 1/2 NPSH	1.03	25
DMHN-16PT16ST	1 NPT x 1 NST	0.51	100
DMHN-24PT24ST	1 1/2 NPT x 1 1/2 NST	0.48	100
DMHN-32PT40ST	2 NPT x 2 1/2 NST	1.34	30
DMHN-40PT40ST	2 1/2 NPT x 2 1/2 NST	1.26	25
DMHN-48PT40ST	3 NPT x 2 1/2 NST	2.14	20
DMHN-24ST24ST	1 1/2 NST x 1 1/2 NST	0.52	100
DMHN-48ST40ST	3 NST x 2 1/2 NST	2.51	20
DMHN-24ST24SH	1 1/2 NST x 1 1/2 NPSH	0.49	100



Brass Cap with Chain

Part Number	Size (in.)	Weight Each (lbs.)	Standard Carton
BCAP-24SH	1 1/2 NPSH	0.55	100
BCAP-24ST	1 1/2 NST	0.53	100
BCAP-40SH	2 1/2 NPSH	1.41	50
BCAP-40ST	2 1/2 NST	1.32	50

Because we continually examine ways to improve our products, we reserve the right to alter specifications or discontinue products without prior notice.



Hydrant & Garden Hose Wrenches / Fittings / Adapters



Brass Hose Nozzle

Part Number	Size (in.)	Weight Each (lbs.)	Standard Carton
BHN-1206GH	3/4 GHT x 6	0.37	100
BHN-1206SH	3/4 NPSH x 6	0.37	100
BHN-1608SH	1 NPSH x 8	0.68	50
BHN-2010SH	1 1/4 NPSH x 10	1.23	30
BHN-2410SH	1 1/2 NPSH x 10	1.32	30
BHN-2410ST	1 1/2 NST x 10	1.32	30
BHN-3212SH	2 NPSH x 12	2.09	20
BHN-4012SH	2 1/2 NPSH x 12	2.87	20
BHN-4012ST	2 1/2 NST x 12	2.87	15



Spanner Wrench

Part Number	Size (in.)	Weight Each (lbs.)	Standard Carton
SW150	1 1/2	0.44	100
SW200	2	0.60	100
SW250	2 1/2	0.68	50
SW300	3	0.99	50
SW400	4	1.30	40



Garden Hose Fitting Set

Part Number	Size (in.)	Thread	Weight Each (lbs.)	Standard Carton
BRGHT050	1/2	GHT	0.25	180
BRGHT062	5/8	GHT	0.25	180
BRGHT075	3/4	GHT	0.25	180
BRNPS100	1	NPS	0.49	120



Universal Spanner Wrench

Part Number	Size Range (in.)	Weight Each (lbs.)	Standard Carton
SWU	1 1/2 - 4 1/2	1.59	30



Female Garden Hose Fitting

Part Number	Size (in.)	Thread	Weight Each (lbs.)	Standard Carton
BRGHT-FEM050	1/2	GHT	0.12	360
BRGHT-FEM062	5/8	GHT	0.12	360
BRGHT-FEM075	3/4	GHT	0.12	360
BRNPS-FEM100	1	NPS	0.25	240



Adjustable Hydrant Wrench

Part Number	Size Range (in.)	Weight Each (lbs.)	Standard Carton
SWLA	1 1/2 - 3	2.91	12



Heavy Duty Adjustable Hydrant Wrench

Part Number	Size Range (in.)	Weight Each (lbs.)	Standard Carton
SWHA	1 1/2 - 6	4.67	12

Because we continually examine ways to improve our products, we reserve the right to alter specifications or discontinue products without prior notice.



Brass Push-On Fittings

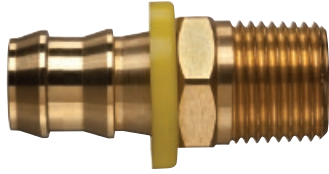

Male Pipe (NPTF Threads)

Part Number	Hose Size (in.)	Fitting Size (in.)	Thread (in.-TPI)	Weight Each (lbs.)	Standard Carton
POFMP-0402	1/4	1/8	1/8 - 27	0.031	100
POFMP-0404	1/4	1/4	1/4 - 18	0.044	100
POFMP-0406	1/4	3/8	3/8 - 18	0.055	50
POFMP-0604	3/8	1/4	1/4 - 18	0.053	50
POFMP-0606	3/8	3/8	3/8 - 18	0.071	50
POFMP-0608	3/8	1/2	1/2 - 14	0.119	25
POFMP-0808	1/2	1/2	1/2 - 14	0.121	25
POFMP-1008	5/8	1/2	1/2 - 14	0.143	25
POFMP-1012	5/8	3/4	3/4 - 14	0.190	25
POFMP-1208	3/4	1/2	1/2 - 14	1.960	25
POFMP-1212	3/4	3/4	3/4 - 14	1.940	25

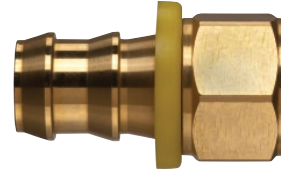

Female Pipe (NPTF Threads)

Part Number	Hose Size (in.)	Fitting Size (in.)	Thread (in.-TPI)	Weight Each (lbs.)	Standard Carton
POFFP-0402	1/4	1/8	1/8 - 27	0.029	100
POFFP-0404	1/4	1/4	1/4 - 18	0.049	100
POFFP-0604	3/8	1/4	1/4 - 18	0.055	50
POFFP-0606	3/8	3/8	3/8 - 18	0.064	50
POFFP-0806	1/2	3/8	3/8 - 18	0.077	50
POFFP-0808	1/2	1/2	1/2 - 14	0.099	25
POFFP-1008	5/8	1/2	1/2 - 14	0.119	25
POFFP-1212	3/4	3/4	3/4 - 14	0.234	25



Male Pipe Swivel (NPTF Threads)

Part Number	Hose Size (in.)	Fitting Size (in.)	Thread (in.-TPI)	Weight Each (lbs.)	Standard Carton
POFMPS-0404	1/4	1/4	1/4 - 18	0.062	50
POFMPS-0606	3/8	3/8	3/8 - 18	0.090	25
POFMPS-0808	1/2	1/2	1/2 - 14	0.143	25
POFMPS-1212	3/4	3/4	3/4 - 14	0.249	25

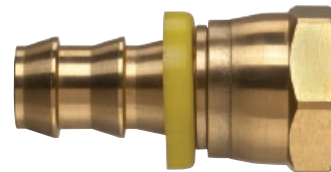

Female Pipe Swivel (NPTF Threads)

Part Number	Hose Size (in.)	Fitting Size (in.)	Thread (in.-TPI)	Weight Each (lbs.)	Standard Carton
POFFPS-0404	1/4	1/4	1/4 - 18	0.060	50
POFFPS-0606	3/8	3/8	3/8 - 18	0.093	50
POFFPS-0808	1/2	1/2	1/2 - 14	0.117	50
POFFPS-1212	3/4	3/4	3/4 - 14	0.214	25

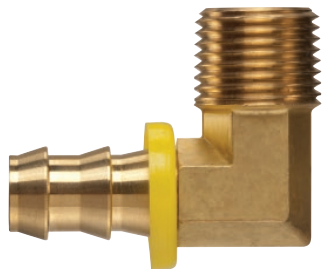

Male Pipe 90 Degree Elbow (NPTF Threads)

Part Number	Hose Size (in.)	Fitting Size (in.)	Thread (in.-TPI)	Weight Each (lbs.)	Standard Carton
POFMPE-0404	1/4	1/4	1/4 - 18	0.062	50
POFMPE-0606	3/8	3/8	3/8 - 18	0.088	25
POFMPE-0808	1/2	1/2	1/2 - 14	0.165	25
POFMPE-1212	3/4	3/4	3/4 - 14	0.293	25

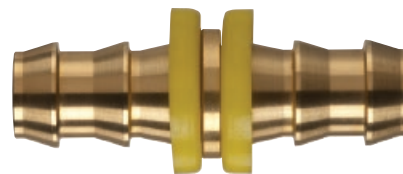

Hose Mender

Part Number	Size (in.)	Weight Each (lbs.)	Standard Carton
POFMD-0404	1/4	0.026	100
POFMD-0606	3/8	0.046	50
POFMD-0808	1/2	0.073	50
POFMD-1010	5/8	0.130	25
POFMD-1212	3/4	0.159	25

Because we continually examine ways to improve our products, we reserve the right to alter specifications or discontinue products without prior notice.



Brass Push-On Fittings

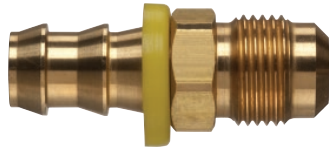

Male JIC 37 Degree Flare (UNF Threads)

Part Number	Hose Size (in.)	Fitting Size (in.)	Thread (in.-TPI)	Weight Each (lbs.)	Standard Carton
POFMJS-0404	1/4	1/4	7/16 - 20	0.035	100
POFMJS-0406	1/4	3/8	9/16 - 18	0.053	100
POFMJS-0606	3/8	3/8	9/16 - 18	0.060	50
POFMJS-0808	1/2	1/2	3/4 - 16	0.121	50
POFMJS-1212	3/4	3/4	1 1/16 - 12	0.291	25

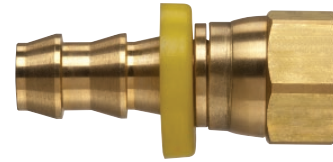

Female JIC 37 Degree Swivel (UNF Threads)

Part Number	Hose Size (in.)	Fitting Size (in.)	Thread (in.-TPI)	Weight Each (lbs.)	Standard Carton
POFFJS-0606	3/8	3/8	9/16 - 18	0.064	50
POFFJS-1212	3/4	3/4	1 1/16 - 12	0.220	25



Male SAE 45 Degree Flare (UNF Threads)

Part Number	Hose Size (in.)	Fitting Size (in.)	Thread (in.-TPI)	Weight Each (lbs.)	Standard Carton
POFMSA-0404	1/4	1/4	7/16 - 20	0.029	100
POFMSA-0606	3/8	3/8	9/16 - 18	0.071	50
POFMSA-0808	1/2	1/2	3/4 - 16	0.112	50
POFMSA-1212	3/4	3/4	1 1/16 - 12	0.324	25

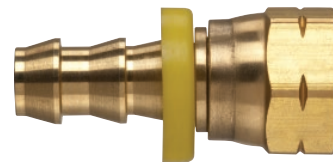

Female SAE 45 Degree Swivel (UNF Threads)

Part Number	Hose Size (in.)	Fitting Size (in.)	Thread (in.-TPI)	Weight Each (lbs.)	Standard Carton
POFFSA-0606	3/8	3/8	9/16 - 18	0.071	100
POFFSA-1212	3/4	3/4	1 1/16 - 12	0.262	25



Female JIC 37 Degree/SAE 45 Degree Swivel (Dual Angle Seat) (UNF Threads)

Part Number	Hose Size (in.)	Fitting Size (in.)	Thread (in.-TPI)	Weight Each (lbs.)	Standard Carton
POFFJS-0404	1/4	1/4	7/16 - 20	0.040	100
POFFJS-0808	1/2	1/2	3/4 - 16	0.097	25
POFFJS-0810	1/2	5/8	7/8 - 14	0.130	25
POFFJS-1010	5/8	5/8	7/8 - 14	0.172	25

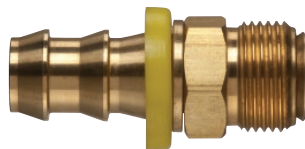

Male Inverted Flare (UNF Threads)

Part Number	Hose Size (in.)	Fitting Size (in.)	Thread (in.-TPI)	Weight Each (lbs.)	Standard Carton
POFMIV-0404	1/4	1/4	7/16 - 24	0.031	100
POFMIV-0405	1/4	5/16	1/2 - 20	0.037	100
POFMIV-0606	3/8	3/8	5/8 - 18	0.071	100
POFMIV-0808	1/2	1/2	3/4 - 16	0.106	50
POFMIV-1010	5/8	5/8	7/8 - 14	0.148	25

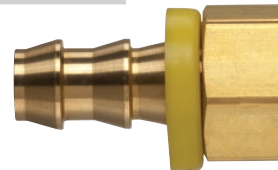

Female Inverted Flare (UNF Threads)

Part Number	Hose Size (in.)	Fitting Size (in.)	Thread (in.-TPI)	Weight Each (lbs.)	Standard Carton
POFFIV-0404	1/4	1/4	7/16 - 24	0.024	100
POFFIV-0405	1/4	5/16	1/2 - 20	0.026	100
POFFIV-0606	3/8	3/8	5/8 - 18	0.053	50
POFFIV-0808	1/2	1/2	3/4 - 16	0.079	25

Because we continually examine ways to improve our products, we reserve the right to alter specifications or discontinue products without prior notice.



Quick Disconnect Couplings

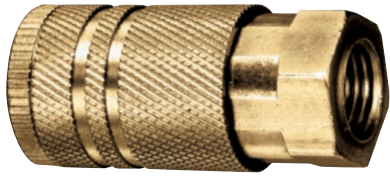

Coupler with Female Thread (NPTF)

Part Number	Body Size (in.)	Thread Size (in.)	Weight Each (lbs.)	Standard Carton
QDAC-4FC	1/4	1/4	0.23	10
QDAC-6FC	1/4	3/8	0.23	10

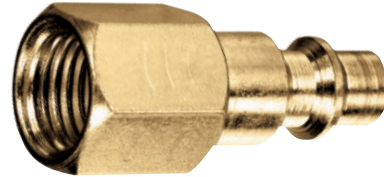

Plug with Female Thread (NPTF)

Part Number	Body Size (in.)	Thread Size (in.)	Weight Each (lbs.)	Standard Carton
QDAP-4FP	1/4	1/4	0.05	10
QDAP-6FP	1/4	3/8	0.05	10

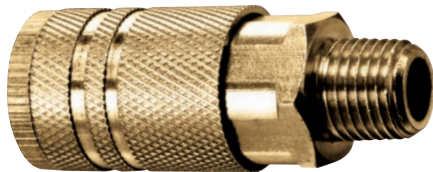

Coupler with Male Thread (NPTF)

Part Number	Body Size (in.)	Thread Size (in.)	Weight Each (lbs.)	Standard Carton
QDAC-4MC	1/4	1/4	0.23	10
QDAC-6MC	1/4	3/8	0.23	10

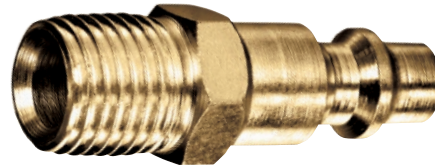

Plug with Male Thread (NPTF)

Part Number	Body Size (in.)	Thread Size (in.)	Weight Each (lbs.)	Standard Carton
QDAP-4MP	1/4	1/4	0.05	10
QDAP-6MP	1/4	3/8	0.05	10

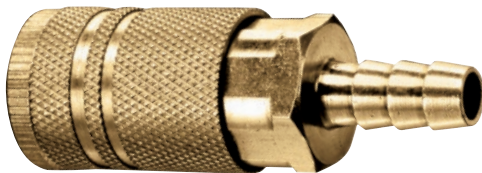

Coupler with Hose Barb

Part Number	Body Size (in.)	Barb Size (in.)	Weight Each (lbs.)	Standard Carton
QDAC-4HC	1/4	1/4	0.23	10
QDAC-6HC	1/4	3/8	0.23	10

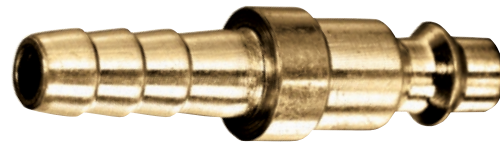

Plug with Hose Barb

Part Number	Body Size (in.)	Barb Size (in.)	Weight Each (lbs.)	Standard Carton
QDAP-4HP	1/4	1/4	0.05	10
QDAP-6HP	1/4	3/8	0.05	10

Specifications

Material

Brass

PSI Rating

300 PSI

Interchange

Industrial

Temperature

240°F (+115°C)

Style

Semi-Automatic

Because we continually examine ways to improve our products, we reserve the right to alter specifications or discontinue products without prior notice.



Miscellaneous Items



Hose Safety Cable
Style WC for Hose-to-Hose Service

Part Number	Hose ID Range (in.)	Size (in.)	Length (in.)	Weight Each (lbs.)	Standard Carton
WC-1	1/2 - 1 1/4	1/8	24	0.24	200
WC-2	1 1/2 - 3	1/4	38	1.15	50



Hose Safety Cable
Style WS for Hose-to-Tool Service

Part Number	Hose ID Range (in.)	Size (in.)	Length (in.)	Weight Each (lbs.)	Standard Carton
WS-1	1/2 - 1 1/4	1/8	20	0.17	200
WS-2	1 1/2 - 3	1/4	38	0.95	50

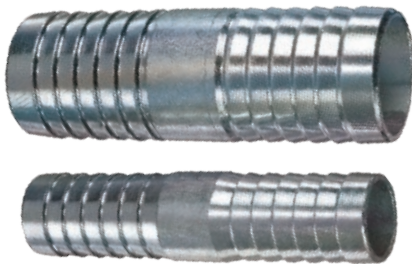

Hose Mender

Part Number	Size (in.)	Weight Each (lbs.)	Standard Carton
SPHM050	1/2	0.10	100
SPHM062	5/8	0.10	100
SPHM075	3/4	0.20	100
SPHM100	1	0.30	50
SPHM125	1 1/4	0.50	50
SPHM150	1 1/2	0.50	40
SPHM200	2	0.80	35
SPHM250	2 1/2	1.70	20
SPHM300	3	2.40	15
SPHM400	4	2.90	9
SPHM600	6	13.20	4
SPHM800	8	20.90	2
SPHM1000	10	28.63	1
SPHM1200	12	48.46	1



Kuri-Cutter Hose & Tubing Cutter

Part Number	Weight Each (lbs.)	Standard Carton
Kuri-Cutter	0.27	1

Because we continually examine ways to improve our products, we reserve the right to alter specifications or discontinue products without prior notice.



Carbon Steel Forged Plate Style Flanges

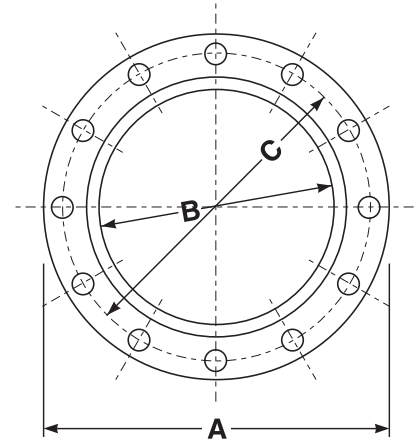

Carbon Steel Forged Plate Flange 150# (ANSI B16.56 & ASTM A-105)

Part Number	Size (in.)	OD A (in.)	Bore B	Circle C (in.)	Thickness (in.)	Number Bolt Holes	Diameter Bolt Holes (in.)	Weight Each (lbs.)
CSPF0050	1/2	3 1/2	0.875	2 3/8	1/2	4	5/8	1.12
CSPF0075	3/4	3 7/8	1.100	2 3/4	1/2	4	5/8	1.36
CSPF0100	1	4 1/4	1.360	3 1/8	1/2	4	5/8	1.58
CSPF0125	1 1/4	4 5/8	1.700	3 1/2	1/2	4	5/8	1.93
CSPF0150	1 1/2	5	1.950	3 7/8	5/8	4	5/8	2.70
CSPF0200	2	6	2.440	4 3/4	5/8	4	3/4	4.10
CSPF0250	2 1/2	7	2.940	5 1/2	5/8	4	3/4	5.35
CSPF0300	3	7 1/2	3.570	6	5/8	4	3/4	5.80
CSPF0400	4	9	4.570	7 1/2	5/8	8	3/4	8.00
CSPF0500	5	10	5.660	8 1/2	3/4	8	7/8	10.37
CSPF0600	6	11	6.720	9 1/2	3/4	8	7/8	11.76
CSPF0800	8	13 1/2	8.720	11 3/4	1	8	7/8	22.48
CSPF1000	10	16	10.880	14 1/4	1	12	1	26.83
CSPF1200	12	19	12.880	17	1	12	1	42.30
CSPF1400	14	21	14.140	18 3/4	1	12	1 1/8	52.50
CSPF1600	16	23 1/2	16.160	21 1/4	1 1/4	16	1 1/8	64.00
CSPF1800	18	25 1/8	18.150	23	1 1/4	16	1 1/4	72.00

Because we continually examine ways to improve our products, we reserve the right to alter specifications or discontinue products without prior notice.



Stainless Steel 304 Forged Plate Style Flanges

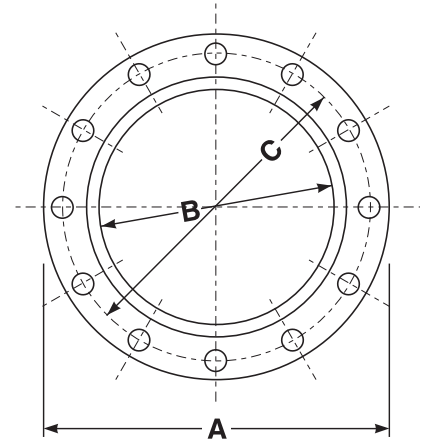

Stainless Steel 304 Forged Plate Flange 150# (ANSI B16.56 & ASTM A-105)

Part Number	Size (in.)	OD A (in.)	Bore B	Circle C (in.)	Thickness (in.)	Number Bolt Holes	Diameter Bolt Holes (in.)	Weight Each (lbs.)
SSPF3040100	1	4 1/4	1.360	3 1/8	1/2	4	5/8	1.66
SSPF3040125	1 1/4	4 5/8	1.700	3 1/2	1/2	4	5/8	2.00
SSPF3040150	1 1/2	5	1.950	3 7/8	1/2	4	5/8	2.24
SSPF3040200	2	6	2.440	4 3/4	1/2	4	3/4	3.06
SSPF3040250	2 1/2	7	2.940	5 1/2	1/2	4	3/4	4.36
SSPF3040300	3	7 1/2	3.570	6	1/2	4	3/4	4.72
SSPF3040400	4	9	4.570	7 1/2	1/2	8	3/4	6.36
SSPF3040500	5	10	5.660	8 1/2	1/2	8	7/8	7.08
SSPF3040600	6	11	6.720	9 1/2	1/2	8	7/8	7.64
SSPF3040800	8	13 1/2	8.720	11 3/4	1/2	8	7/8	11.44
SSPF3041000	10	16	10.880	14 1/4	1/2	12	1	13.36
SSPF3041200	12	19	12.880	17	1/2	12	1	21.00
SSPF3041400	14	21	14.140	18 3/4	1/2	12	1 1/8	27.83

Because we continually examine ways to improve our products, we reserve the right to alter specifications or discontinue products without prior notice.



Stainless Steel 316 Forged Plate Style Flanges

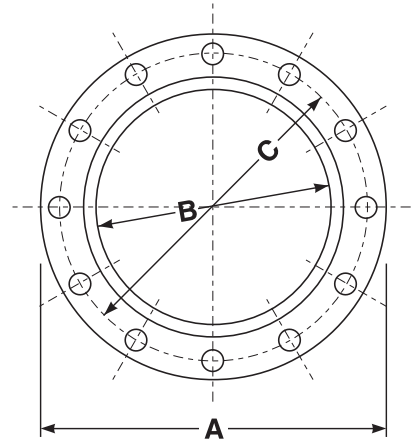

Stainless Steel 316 Forged Plate Flange 150# (ANSI B16.56 & ASTM A-105)

Part Number	Size (in.)	OD A (in.)	Bore B	Circle C (in.)	Thickness (in.)	Number Bolt Holes	Diameter Bolt Holes (in.)	Weight Each (lbs.)
SSPF3160075	3/4	3 7/8	1.100	2 3/4	1/2	4	5/8	1.36
SSPF3160100	1	4 1/4	1.360	3 1/8	1/2	4	5/8	1.66
SSPF3160125	1 1/4	4 5/8	1.700	3 1/2	1/2	4	5/8	2.00
SSPF3160150	1 1/2	5	1.950	3 7/8	1/2	4	5/8	2.24
SSPF3160200	2	6	2.440	4 3/4	1/2	4	3/4	3.06
SSPF3160250	2 1/2	7	2.940	5 1/2	1/2	4	3/4	4.36
SSPF3160300	3	7 1/2	3.570	6	1/2	4	3/4	4.72
SSPF3160400	4	9	4.570	7 1/2	1/2	8	3/4	6.36
SSPF3160500	5	10	5.660	8 1/2	1/2	8	7/8	7.08
SSPF3160600	6	11	6.720	9 1/2	1/2	8	7/8	7.64
SSPF3160800	8	13 1/2	8.720	11 3/4	1/2	8	7/8	11.44
SSPF3161000	10	16	10.880	14 1/4	1/2	12	1	13.36
SSPF3161200	12	19	12.880	17	1/2	12	1	21.00
SSPF3161400	14	21	14.140	18 3/4	1/2	12	1 1/8	27.83
SSPF3161600	16	23 1/2	16.160	21 1/4	1/2	16	1 1/8	30.00

Because we continually examine ways to improve our products, we reserve the right to alter specifications or discontinue products without prior notice.



Carbon Steel Forged Raised Face Slip-on Flanges

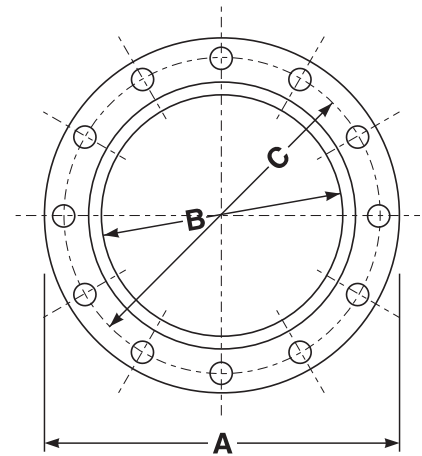

Carbon Steel Forged Raised Face Slip-On Flange 150# (ANSI B16.56 & ASTM A-105)

Part Number	Size (in.)	OD A (in.)	Bore B	Circle C (in.)	Thickness (in.)	Number Bolt Holes	Diameter Bolt Holes (in.)	Weight Each (lbs.)
CSRF1500050	1/2	3 1/2	0.875	2 3/8	5/8	4	5/8	1.10
CSRF1500075	3/4	3 7/8	1.100	2 3/4	5/8	4	5/8	1.98
CSRF1500100	1	4 1/4	1.360	3 1/8	3/4	4	5/8	2.18
CSRF1500125	1 1/4	4 5/8	1.700	3 1/2	7/8	4	5/8	3.09
CSRF1500150	1 1/2	5	1.950	3 7/8	7/8	4	5/8	3.60
CSRF1500200	2	6	2.440	4 3/4	1	4	3/4	5.07
CSRF1500250	2 1/2	7	2.940	5 1/2	1 1/8	4	3/4	7.05
CSRF1500300	3	7 1/2	3.570	6	1 1/4	4	3/4	7.94
CSRF1500400	4	9	4.570	7 1/2	1 3/8	8	3/4	13.01
CSRF1500500	5	10	5.660	8 1/2	1 3/8	8	7/8	14.99
CSRF1500600	6	11	6.720	9 1/2	1 1/2	8	7/8	18.74
CSRF1500800	8	13 1/2	8.720	11 3/4	1 3/4	8	7/8	29.98
CSRF1501000	10	16	10.880	14 1/4	2	12	1	42.99
CSRF1501200	12	19	12.880	17	2 1/8	12	1	63.93
CSRF1501400	14	21	14.140	18 3/4	2 1/4	12	1 1/8	90.39

Carbon Steel Forged Raised Face Slip-On Flange 300# (ANSI B16.56 & ASTM A-105)

Part Number	Size (in.)	OD A (in.)	Bore B	Circle C (in.)	Thickness (in.)	Number Bolt Holes	Diameter Bolt Holes (in.)	Weight Each (lbs.)
CSRF3000050	1/2	3 3/4	0.875	2 5/8	7/8	4	5/8	1.92
CSRF3000075	3/4	4 5/8	1.100	3 1/4	1	4	3/4	2.53
CSRF3000100	1	4 7/8	1.360	3 1/2	1 1/16	4	3/4	3.09
CSRF3000125	1 1/4	5 1/4	1.700	3 7/8	1 1/16	4	3/4	3.56
CSRF3000150	1 1/2	6 1/8	1.950	4 1/2	1 3/16	4	7/8	5.01
CSRF3000200	2	6 1/2	2.440	5	1 5/16	8	3/4	7.05
CSRF3000250	2 1/2	7 1/2	2.940	5 7/8	1 1/2	8	7/8	9.92
CSRF3000300	3	8 1/4	3.570	6 5/8	1 11/16	8	7/8	13.01
CSRF3000400	4	10	4.570	7 7/8	1 7/8	8	7/8	22.05
CSRF3000500	5	11	5.660	9 1/4	2	8	7/8	28.00
CSRF3000600	6	12 1/2	6.720	10 5/8	1 1/16	12	7/8	39.02
CSRF3000800	8	15	8.720	13	2 7/16	12	1	57.98

Because we continually examine ways to improve our products, we reserve the right to alter specifications or discontinue products without prior notice.



Carbon Steel Forged Raised Face Threaded Flanges

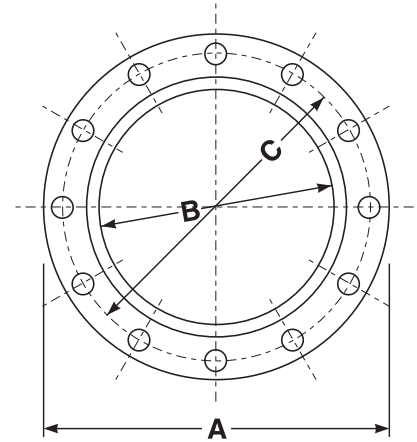

Carbon Steel Forged Raised Face Threaded Flange 150# (ANSI B16.56 & ASTM A-105)

Part Number	Size (in.)	OD A (in.)	Bore B	Circle C (in.)	Thickness (in.)	Number Bolt Holes	Diameter Bolt Holes (in.)	Weight Each (lbs.)
CSRFTHD1500050	1/2	3 1/2	0.875	2 3/8	5/8	4	5/8	1.10
CSRFTHD1500075	3/4	3 7/8	1.100	2 3/4	5/8	4	5/8	1.98
CSRFTHD1500100	1	4 1/4	1.360	3 1/8	3/4	4	5/8	2.18
CSRFTHD1500125	1 1/4	4 5/8	1.700	3 1/2	7/8	4	5/8	3.09
CSRFTHD1500150	1 1/2	5	1.950	3 7/8	7/8	4	5/8	3.60
CSRFTHD1500200	2	6	2.440	4 3/4	1	4	3/4	5.07
CSRFTHD1500250	2 1/2	7	2.940	5 1/2	1 1/8	4	3/4	7.05
CSRFTHD1500300	3	7 1/2	3.570	6	1 1/4	4	3/4	7.94
CSRFTHD1500400	4	9	4.570	7 1/2	1 3/8	8	3/4	13.01
CSRFTHD1500500	5	10	5.660	8 1/2	1 3/8	8	7/8	14.99
CSRFTHD1500600	6	11	6.720	9 1/2	1 1/2	8	7/8	18.74
CSRFTHD1500800	8	13 1/2	8.720	11 3/4	1 3/4	8	7/8	29.98
CSRFTHD1501000	10	16	10.880	14 1/4	2	12	1	42.99
CSRFTHD1501200	12	19	12.880	17	2 1/8	12	1	63.93

Because we continually examine ways to improve our products, we reserve the right to alter specifications or discontinue products without prior notice.



Stainless Steel 304 Forged Raised Face Slip-on Flanges

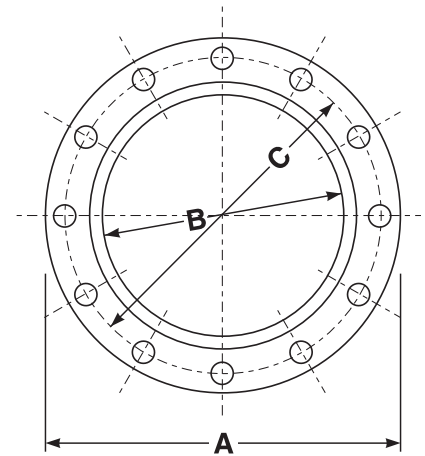

Stainless Steel 304 Forged Raised Face Slip-On Flange 150# (ANSI B16.56 & ASTM A-105)

Part Number	Size (in.)	OD A (in.)	Bore B	Circle C (in.)	Thickness (in.)	Number Bolt Holes	Diameter Bolt Holes (in.)	Weight Each (lbs.)
SSRF3041500050	1/2	3 1/2	0.875	2 3/8	5/8	4	5/8	1.10
SSRF3041500075	3/4	3 7/8	1.100	2 3/4	5/8	4	5/8	1.98
SSRF3041500100	1	4 1/4	1.360	3 1/8	3/4	4	5/8	2.18
SSRF3041500125	1 1/4	4 5/8	1.700	3 1/2	7/8	4	5/8	3.09
SSRF3041500150	1 1/2	5	1.950	3 7/8	7/8	4	5/8	3.60
SSRF3041500200	2	6	2.440	4 3/4	1	4	3/4	5.07
SSRF3041500250	2 1/2	7	2.940	5 1/2	1 1/8	4	3/4	7.05
SSRF3041500300	3	7 1/2	3.570	6	1 1/4	4	3/4	7.94
SSRF3041500400	4	9	4.570	7 1/2	1 3/8	8	3/4	13.01
SSRF3041500500	5	10	5.660	8 1/2	1 3/8	8	7/8	14.99
SSRF3041500600	6	11	6.720	9 1/2	1 1/2	8	7/8	18.74
SSRF3041500800	8	13 1/2	8.720	11 3/4	1 3/4	8	7/8	29.98
SSRF3041501000	10	16	10.880	14 1/4	2	12	1	42.99

Because we continually examine ways to improve our products, we reserve the right to alter specifications or discontinue products without prior notice.



Single Sphere Rubber Expansion Joints

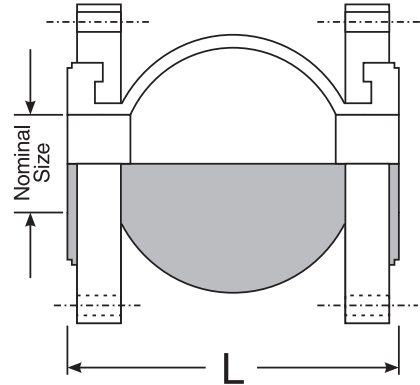
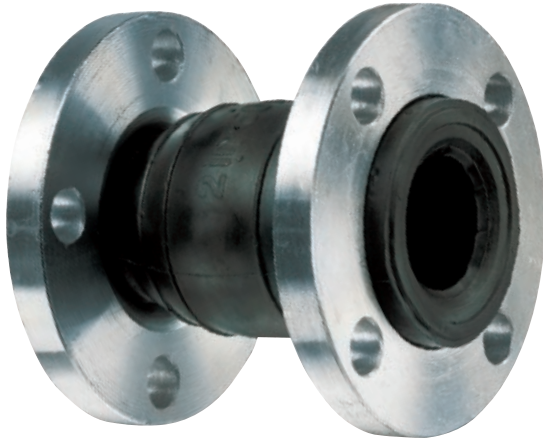

Single Sphere Flanged Rubber Expansion Joint

Part Number	Size (in.)	Length (L - in.)	Allowable Movement				Operating Conditions			
			Axial Compression (in.)	Axial Elongation (in.)	Transverse Deflection (in.)	Angular Deflection (Degrees)	Maximum Pressure (PSI)	Maximum Temperature (°F)	Vacuum (HG)	Weight Each (lbs.)
HTSRF12x6	1 1/4	6	1/2	3/8	1/2	15	225	220	16	5.00
HTSRF15x6	1 1/2	6	1/2	3/8	1/2	15	225	220	16	6.10
HTSRF20x6	2	6	1/2	3/8	1/2	15	225	220	16	8.90
HTSRF25x6	2 1/2	6	1/2	3/8	1/2	15	225	220	16	12.30
HTSRF30x6	3	6	1/2	3/8	1/2	15	225	220	16	14.00
HTSRF40x6	4	6	5/8	3/8	1/2	15	225	220	16	18.30
HTSRF50x6	5	6	5/8	3/8	1/2	15	225	220	16	22.80
HTSRF60x6	6	6	5/8	3/8	1/2	15	225	220	16	26.80
HTSRF80x6	8	6	5/8	3/8	1/2	15	225	220	16	40.60
HTSRF100x8	10	8	3/4	1/2	3/4	15	225	220	16	56.60
HTSRF120x8	12	8	3/4	1/2	3/4	15	225	220	16	83.00
HTSRF140x8	14	8	3/4	1/2	3/4	15	140	220	16	115.00
HTSRF160x8	16	8	3/4	1/2	3/4	15	140	220	16	165.00
HTSRF180x8	18	8	3/4	1/2	3/4	15	125	220	16	168.00
HTSRF200x8	20	8	3/4	1/2	3/4	15	125	220	16	170.00

See applications and specifications on page 64.

Because we continually examine ways to improve our products, we reserve the right to alter specifications or discontinue products without prior notice.



Double Sphere and Threaded Union Rubber Expansion Joints

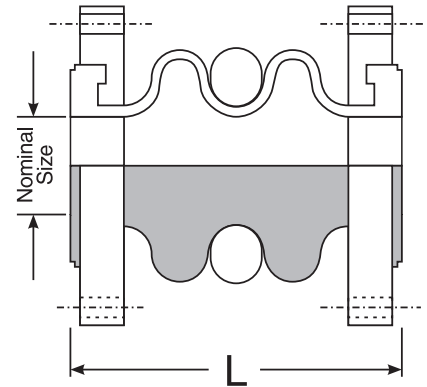

Double Sphere Flanged Rubber Expansion Joint

Part Number	Size (in.)	Length (L - in.)	Allowable Movement				Operating Conditions			
			Axial Compression (in.)	Axial Elongation (in.)	Transverse Deflection (in.)	Angular Deflection (Degrees)	Maximum Pressure (PSI)	Maximum Temperature (°F)	Vacuum (HG)	Weight Each (lbs.)
HTDRF12x7	1 1/4	7	2	1 1/4	1 1/2	40	150	220	16	5.30
HTDRF15x7	1 1/2	7	2	1 1/4	1 1/2	40	150	220	16	6.80
HTDRF20x7	2	7	2	1 1/4	1 1/2	40	150	220	16	9.00
HTDRF25x7	2 1/2	7	2	1 1/4	1 1/2	40	150	220	16	13.30
HTDRF30x7	3	7	2	1 1/4	1 1/2	40	150	220	16	14.30
HTDRF40x9	4	9	2 1/4	1 1/2	1 3/4	35	150	220	16	20.30
HTDRF50x9	5	9	2 1/4	1 1/2	1 3/4	35	150	220	16	24.50
HTDRF60x9	6	9	2 1/4	1 1/2	1 3/4	35	150	220	16	29.50
HTDRF80x13	8	13	2 1/2	1 1/2	1 3/4	30	150	220	16	43.80
HTDRF100x13	10	13	2 1/2	1 1/2	1 3/4	30	150	220	16	64.10
HTDRF120x13	12	13	2 1/2	1 1/2	1 3/4	30	150	220	16	95.00

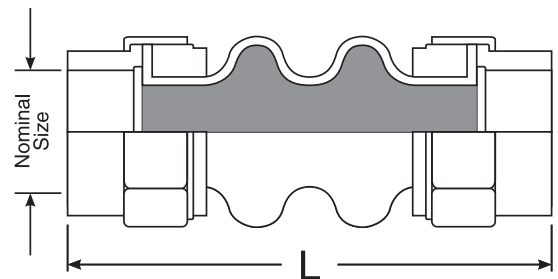

Threaded Union Rubber Expansion Joint

Part Number	Size (in.)	Length (L - in.)	Allowable Movement				Operating Conditions			
			Axial Compression (in.)	Axial Elongation (in.)	Transverse Deflection (in.)	Angular Deflection (Degrees)	Maximum Pressure (PSI)	Maximum Temperature (°F)	Vacuum (HG)	Weight Each (lbs.)
HTDRU0075	3/4	8	7/8	1/4	7/8	45	150	240	16	1.80
HTDRU0100	1	8	7/8	1/4	7/8	45	150	240	16	2.80
HTDRU0125	1 1/4	8	7/8	1/4	7/8	45	150	240	16	3.50
HTDRU0150	1 1/2	8	7/8	1/4	7/8	45	150	240	16	4.00
HTDRU0200	2	8	7/8	1/4	7/8	45	150	240	16	5.00

See applications and specifications on page 64.

Because we continually examine ways to improve our products, we reserve the right to alter specifications or discontinue products without prior notice.



Rubber Expansion Joints

Features & Benefits

- Excellent ability to absorb vibration and sound
- Allows for four-way movement
- Withstands high pressure
- Easy installation using either floating flanges or threaded unions
- Excellent for use with moderate chemicals, most oils, fats, grease, and many solvents
- A retention ring is supplied with all double sphere flanged expansion joints

Construction:

- Nylon fabric-reinforced neoprene body with forged carbon steel flanges or cast ductile iron pipe unions

Note:

- Not for use with oxidizing acids, esters, and ketones

Elastomer Physical Properties & Chemical Resistance

Material Designation	Neoprene	Material Designation	Neoprene
ANSI/ASTM D1418-17	CR	Dielectric Strength	Very Good
ASTM D-2000 SAE J-200	BC, BE	Electrical Insulation	Fair/Good
Ozone	Very Good	Water Absorption	Good
Weather	Excellent	Radiation	Very Good
Sunlight	Very Good	Swelling in Oil	Good
Oxidation	Very Good	Acid, Diluted	Excellent
Heat	Good	Acid, Concentrated	Good
Cold	Good	Aliphatic Hydrocarbons	Fair/Good
Flame	Good	Aromatic Hydrocarbons	Fair
Tear	Good	Oxygenated Hydrocarbons	Poor/Fair
Abrasion	Very Good	Lacquers	Poor
Impermeability	Good	Oil & Gasoline	Good
Dynamic	Fair	Alkali, Diluted	Good
Rebound-Hot	Very Good	Alkali, Concentrated	Poor
Rebound-Cold	Good	Animal & Vegetable Oil	Good
Comp. Set	Fair	Chemical	Fair/Good
Tensile Strength	Good	Water	Good

Because we continually examine ways to improve our products, we reserve the right to alter specifications or discontinue products without prior notice.



Why Rubber Expansion Joints?

There are a number of reasons why rubber expansion joints can provide the ideal solution to your piping and plumbing problems:

- **Minimal face-to-face dimensions** — Rubber expansion joints require considerably less space than typical expansion bends or loops and frequently have a lower pressure drop. This can translate into savings on installation costs, as well as improved performance.
- **Light weight** — Rubber expansion joints are relatively light in weight. This makes installation easier and less costly.
- **Low movement forces required** — The natural flexibility of rubber expansion joints allows almost unlimited flexing and recovery, as well as requiring less force to move. This helps prevent damage to costly equipment and expensive down time.
- **Reduced fatigue factor** — The elastomers used in rubber expansion joints are not subject to fatigue breakdown or embrittlement. And they prevent electrolytic action.
- **Reduced heat loss** — Rubber expansion

joints reduce heat losses and give longer maintenance-free service.

- **Corrosion- and erosion-resistance** — The superior corrosion-resistant characteristics of rubber expansion joints permit the safe handling of a wide variety of materials within the rated pressures and temperatures

Typical Applications

Air Conditioning, Heating & Ventilation Systems

- Commercial & institutional buildings
- Hospitals
- Schools
- Motels
- Apartments
- Hotels
- Stores
- Aboard ships & boats

Central & Ancillary Power Generating Stations

- Communities
- Buildings
- Factories
- Aboard ships & boats

Sewage Disposal & Water Treatment Plants

Irrigation & Fire Fighting Stations

Process Piping

- Pulp & paper
- Chemical
- Primary metal
- Petroleum refining

Rubber Expansion Joints Movement

Expansion joints are designed to absorb different movements concurrently

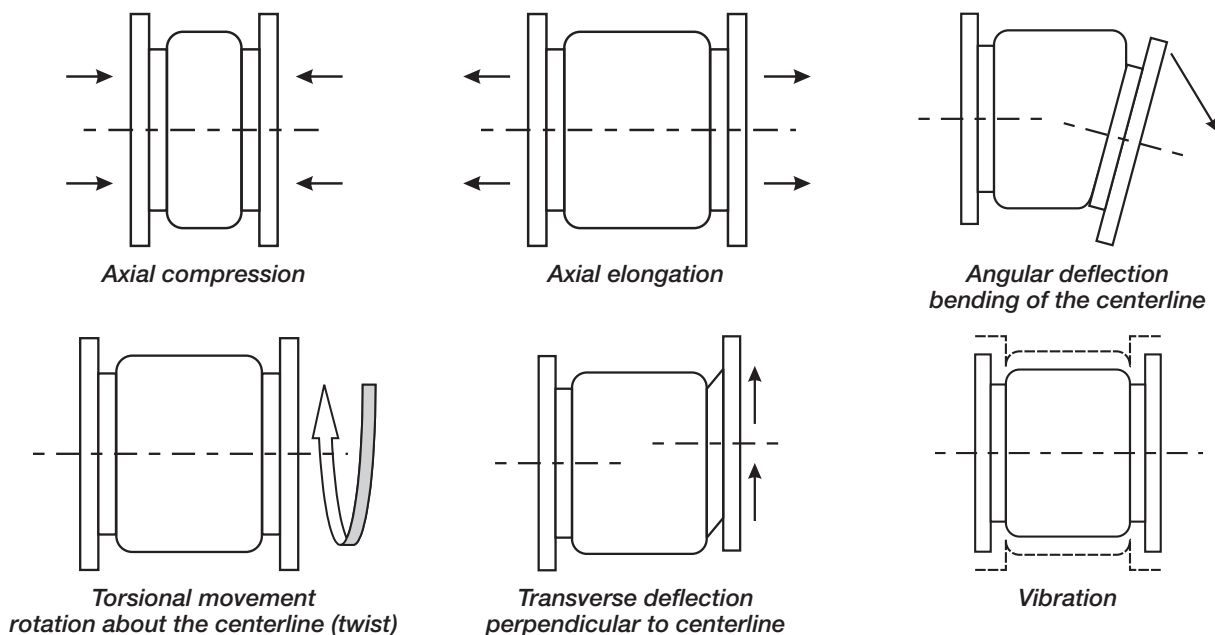

Because we continually examine ways to improve our products, we reserve the right to alter specifications or discontinue products without prior notice.



Gaskets



Buna-N Gasket for Quick-Acting Couplings

Temperature Rating -40°F (-40°C) to 250°F (+121°C)

Part Number	Size (in.)	Weight Each (lbs.)	Standard Carton
BUNA075	3/4	0.008	10
BUNA100	1	0.010	10
BUNA125	1 1/4	0.016	10
BUNA150	1 1/2	0.018	10
BUNA200	2	0.022	10
BUNA250	2 1/2	0.034	10
BUNA300	3	0.042	10
BUNA400	4	0.066	10
BUNA500	5	0.094	10
BUNA600	6	0.116	10
BUNA800	8	0.220	10
BUNA801	8	0.240	10
BUNA1000	10	0.390	10

Note: Sold in standard carton quantity only.



EPDM Gasket for Quick-Acting Couplings

Temperature Rating -60°F (-51°C) to 300°F (+149°C)

Part Number	Size (in.)	Weight Each (lbs.)	Standard Carton
EPDM100	1	0.010	10
EPDM125	1 1/4	0.016	10
EPDM150	1 1/2	0.018	10
EPDM200	2	0.022	10
EPDM250	2 1/2	0.034	10
EPDM300	3	0.042	10
EPDM400	4	0.066	10

Note: Sold in standard carton quantity only.



NEW

Replacement Elastomer Seal (Lip Type) for Hammer Unions

Temperature Rating -40°F (-40°C) to 250°F (+121°C)

Part Number	Size (in.)	Weight Each (lbs.)	Standard Carton
HUS-2	2	0.100	1
HUS-3	3	0.150	1
HUS-4	4	0.200	1



Viton Gasket for Quick-Acting Couplings

Temperature Rating -20°F (-28°C) to 400°F (+240°C)

Part Number	Size (in.)	Weight Each (lbs.)	Standard Carton
VITON050	1/2	0.007	10
VITON075	3/4	0.007	10
VITON100	1	0.010	10
VITON125	1 1/4	0.016	10
VITON150	1 1/2	0.018	10
VITON200	2	0.022	10
VITON250	2 1/2	0.034	10
VITON300	3	0.042	10
VITON400	4	0.066	10

Note: Sold in standard carton quantity only.

Because we continually examine ways to improve our products, we reserve the right to alter specifications or discontinue products without prior notice.



Gaskets

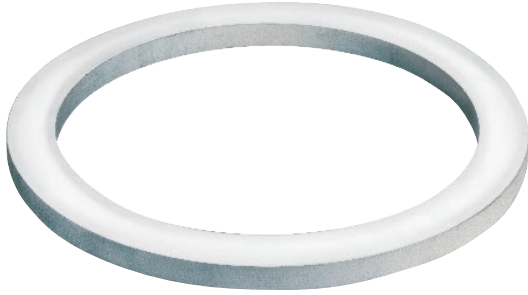

White Neoprene (FDA) Gasket for Quick-Acting Couplings

Temperature Rating -45°F (-43°C) to 250°F (+121°C)

Part Number	Size (in.)	Weight Each (lbs.)	Standard Carton
WN100	1	0.010	10
WN200	2	0.022	10
WN300	3	0.042	10
WN400	4	0.066	10
WN500	5	0.094	10
WN600	6	0.116	10

Note: Sold in standard carton quantity only.



BUNA-N Shank Band for EZ-Seal™ Leak Resistant Couplings

Temperature Rating -40°F (-40°C) to 250°F (+121°C)

Part Number	Size (in.)	Weight Each (lbs.)	Standard Carton
NBR-LF150	1 1/2	0.004	10
NBR-LF200	2	0.009	10
NBR-LF300	3	0.029	10
NBR-LF400	4	0.040	10

Note: Sold in standard carton quantity only.



BUNA-N Gasket for API Petroleum Couplings

Temperature Rating -40°F (-40°C) to 250°F (+121°C)

Part Number	Size (in.)	Weight Each (lbs.)	Standard Carton
TCG-400	4	0.070	1



Gaskets



Buna-N Gasket for Pin Lug Couplings

Temperature Rating -40°F (-40°C) to 250°F (+121°C)

Part Number	Size (in.)	Weight Each (lbs.)	Standard Carton
HW150	1 1/2	0.008	25
HW200	2	0.012	25
HW250	2 1/2	0.017	25
HW300	3	0.031	25
HW400	4	0.050	25
HW600	6	0.094	10



Buna-N Gasket for Fire Hydrant Pin Lug Couplings

Temperature Rating -40°F (-40°C) to 250°F (+121°C)

Part Number	Size (in.)	Weight Each (lbs.)	Standard Carton
FHW150	1 1/2	0.008	40
FHW250	2 1/2	0.017	10



Natural Rubber Gasket for Sandblast Couplings

Temperature Rating -60°F (-51°C) to 220°F (+104°C)

Part Number	Weight Each (lbs.)	Standard Carton
SBG	0.032	10
SRG-2	0.063	10

Note: Sold in standard carton quantity only.



Buna-N Gasket for Universal Couplings

Temperature Rating -20°F (-29°C) to 150°F (+65°C)

Part Number	Size Range (in.)	Weight Each (lbs.)	Standard Carton
AHG-75	1/2 - 1	0.010	10
AHG-100	1 1/4 - 2	0.020	10

Note: Sold in standard carton quantity only.



Handles



Brass Handle Set for Quick-Acting Couplings
(Including SS Slot Pins, SS Pull Rings, CS Safety Clips)

Part Number	Size Range (in.)	Weight Each (lbs.)	Standard Carton
HA BRASS075	1/2 - 3/4	0.10	1
HA BRASS100	1	0.16	1
HA BRASS200	1 1/4 - 2 1/2	0.20	1
HA BRASS300	3 - 5	0.28	1
HA BRASS600	6 - 10	0.52	1



304 Stainless Steel Handle Set for Quick-Acting Couplings
(Including SS Slot Pins, SS Pull Rings, SS Safety Clips)

Part Number	Size Range (in.)	Weight Each (lbs.)	Standard Carton
HA ST-STL075	1/2 - 3/4	0.08	1
HA ST-STL100	1	0.10	1
HA ST-STL200	1 1/4 - 2 1/2	0.16	1
HA ST-STL300	3 - 5	0.26	1
HA ST-STL600	6 - 8	0.75	1



K-Loc™ Auto Lock 316 Stainless Steel Handle Set
(Including SS Slot Pins, SS Safety Clips, SS Pull Rings)

Part Number	Size Range (in.)	Weight Each (lbs.)	Standard Carton
K-LOCSSHA200	1 1/2 - 2	2.50	1
K-LOCSSHA300	3	3.30	1



Polypropylene Ball Valve Handle

Part Number	Size Range (in.)	Weight Each (lbs.)	Standard Carton
HA POLY100	1/2 - 1	0.06	60
HA POLY150	1 1/4 - 1 1/2	0.14	40
HA POLY200	2 - 4	0.27	20

Because we continually examine ways to improve our products, we reserve the right to alter specifications or discontinue products without prior notice.



Safety Clips



304 Stainless Steel Safety Clip
(For use with Quick-Acting Couplings)

Part Number	Size Range (in.)	Weight Each (lbs.)	Standard Carton
SCSS-200	3/4 - 5	0.010	10
SCSS-600	6 - 8	0.016	10

Note: Sold in standard carton quantity only.



Carbon Steel Safety Clip with Lanyard
(For use with all Universal and Sandblast Couplings)

Part Number	Weight Each (lbs.)	Standard Carton
USCL	0.025	10

Note: Sold in standard carton quantity only.



Chemical Resistance Chart

These recommendations are based upon information from material suppliers and careful examination of available published information and are believed to be accurate. However, since the resistance of metals, plastics and elastomers can be affected by concentration, temperature, presence of other chemicals and other factors, this information should be considered as a general guide rather than an unqualified guarantee. All recommendations assume ambient temperatures unless otherwise noted. The ratings for these materials are based upon the chemical resistance only. Added consideration must be given to pump selections when the chemical is abrasive, viscous in nature, or has a Specific Gravity greater than 1.1

RATINGS - CHEMICAL EFFECT

A: No effect - Excellent **B:** Minor effect - Good **C:** Moderate effect - Fair **D:** Severe effect - Not Recommended

	304 Stainless Steel	316 Stainless Steel	Aluminum	Cast Bronze	Brass	Cast Iron	Carbon Steel	Nylon	Polypropylene	Viton	Buna-N	Neoprene	EPDM	Natural Rubber
Acetaldehyde5	A	A	B	D	-	-	C	A	B	D	B	D	B	C
Acetamide	B	A	-	-	-	C	-	-	A	A	A	A	A	D
Acetate Solv.2	B	A	B	A	C	B	A	A	D	D	D	D	-	-
Acetic Acid, Glacia1	B	A	B	C	C	D	A	D	B	D	D	C	B	C
Acetic Acid 20%	B	A	-	-	C	-	-	D	A	A	C	C	-	-
Acetic Acid 80%	B	A	-	-	C	-	-	D	B	A	C	D	-	-
Acetic Acid	B	A	B	C	C	D	C	D	A	C	C	C	B	C
Acetic Anhydride	A	A	B	C	D	B	D	D	A	D	A	B	B	C
Acetone6	A	A	A	A	A	A	A	A	B	D	D	C	A	D
Acetyl Chloride	C	A	-	D	-	-	-	-	A	-	-	-	-	A
Acetylene2	A	A	A	B	-	A	A	D	A	A	A	B	A	C
Acrylonitrile	A	C	B	A	-	C	-	-	B	C	D	D	D	-
Alcohols Amyl	A	A	C	A	B	C	C	A	B	A	A	A	A	C
Benzyl	A	A	B	A	C	-	-	A	A	A	D	B	B	D
Butyl	A	A	B	B	C	C	C	A	B	A	A	A	A	A
Diacetone2	A	A	A	A	C	-	A	A	D	D	D	D	A	D
Ethyl	A	A	B	A	C	A	A	A	A	A	A	A	B	A
Hexyl	A	A	A	A	C	-	A	A	A	A	A	A	B	A
Isobutyl	A	A	B	A	C	-	A	A	A	A	C	A	A	A
Isopropyl	A	A	B	A	C	C	A	A	A	A	C	B	A	A
Methyl6	A	A	B	A	C	A	A	A	A	C	B	A	A	A
Octyl	A	A	A	A	C	-	A	A	-	A	B	B	A	C
Propyl	A	A	A	A	-	-	A	A	A	A	A	A	A	A
Aluminum Chloride 20%	D	C	B	D	-	D	A	A	A	A	A	A	A	A
Aluminum Chloride	D	C	D	C	-	D	B	D	A	A	A	A	-	-
Aluminum Fluoride	D	C	-	-	-	-	A	D	A	A	A	A	-	C
Aluminum Hydroxide6	A	A	A	A	-	D	A	A	A	A	A	A	-	A
Alum Potassium Sulfate (Alum), 10%	A	-	A	-	-	D	A	A	-	A	-	A	-	A
Alum Potassium Sulfate (Alum), 100%	D	A	B	C	-	-	A	D	A	A	A	A	-	A
Aluminum Sulfate	C	C	A	C	C	D	A	A	A	A	A	A	A	A
Amines	A	A	A	B	-	A	B	A	-	D	D	B	B	C
Ammonia 10%	-	A	-	-	-	-	A	A	A	D	A	-	-	-
Ammonia, Anhydrous	B	A	B	D	-	D	B	A	A	D	B	A	A	D
Ammonia, Liquids	A	A	D	D	-	A	A	-	A	D	B	A	A	D
Ammonia, Nitrate	A	A	C	D	-	-	A	-	A	-	A	C	-	-
Ammonium Bifluoride	C	A	D	-	-	-	-	A	A	A	A	-	-	-
Ammonium Carbonate	A	A	C	B	-	C	B	A	A	B	D	A	A	-
Ammonium Casenite	-	A	-	-	-	-	-	-	-	-	-	A	-	-
Ammonium Chloride	A	C	C	D	C	D	D	A	A	A	A	A	A	A
Ammonium Hydroxide	A	A	C	D	D	A	C	A	A	B	B	A	A	C
Ammonium Nitrate	A	A	B	D	D	A	D	A	D	A	D	A	A	A
Ammonium Oxalate	A	A	-	-	-	-	A	-	-	-	A	A	-	-
Ammonium Persulfate	A	A	C	A	-	D	A	D	A	C	A	A	A	A

	304 Stainless Steel	316 Stainless Steel	Aluminum	Cast Bronze	Brass	Cast Iron	Carbon Steel	Nylon	Polypropylene	Viton	Buna-N	Neoprene	EPDM	Natural Rubber
Ammonium Phosphate, Dibasic	A	A	B	C	-	-	D	A	A	A	A	A	A	A
Ammonium Phosphate, Monobasic	A	A	B	D	-	-	A	A	A	A	A	A	A	A
Ammonium Phosphate, Tribasic	A	A	B	C	-	C	D	A	A	A	A	A	A	A
Ammonium Sulfate	D	B	B	B	C	C	C	D	A	D	A	A	A	A
Ammonium Thio-Sulfate	-	A	-	-	-	D	A	-	-	-	A	A	-	-
Amyl-Acetate	A	A	B	C	-	-	C	B	D	D	D	D	A	D
Amyl Alcohol	A	A	B	A	-	-	A	A	A	B	B	A	A	C
Amyl Chloride	C	B	D	A	-	-	A	C	D	A	D	D	D	D
Aniline	A	A	C	C	-	-	C	C	B	C	D	D	B	D
Anti-Freeze	A	A	A	B	B	B	C	A	A	A	A	A	A	A
Antimony Trichloride	D	D	D	-	-	-	-	D	-	A	-	C	-	A
Aqua Regia (80%, HCl, 20%, HNO)	D	D	D	D	-	-	-	D	C	C	D	D	D	D
Arochlor 1248	-	-	-	-	-	-	A	-	-	A	D	D	B	D
Aromatic Hydrocarbons	-	A	A	A	-	A	A	-	-	A	D	D	D	D
Arsenic Acid	A	A	D	D	B	D	D	A	A	A	A	A	-	C
Asphalt	B	A	C	A	-	C	-	A	A	A	B	B	D	D
Barium Carbonate	A	A	B	B	-	B	B	A	A	A	A	A	-	A
Barium Chloride	D	A	D	B	-	-	C	B	A	A	A	A	A	A
Barium Cyanide	-	A	-	C	-	-	A	-	-	A	C	A	A	-
Barium Hydroxide	C	A	D	B	-	C	C	A	A	A	A	A	A	A
Barium Nitrate	A	A	-	D	-	A	A	-	-	A	A	A	A	-
Barium Sulfate	A	A	D	C	-	C	C	A	A	A	A	A	A	-
Beet Sugar Liquids	A	A	A	A	B	A	-	A	A	A	A	B	A	A
Benzaldehyde3	A	A	B	A	-	B	A	C	D	D	D	D	A	D
Benzene2	A	A	B	B	A	B	C	A	D	A	D	D	D	D
Benzoic Acid2	A	A	B	B	-	D	-	D	D	A	D	D	D	D
Benzol	A	A	B	B	A	-	-	A	A	D	D	D	-	-
Borax (Sodium Borate)	A	A	C	A	B	A	C	A	A	A	B	A	A	C
Boric Acid	A	A	B	B	C	D	-	A	A	A	A	A	A	A
Brewery Slop	-	A	-	A	-	A	-	-	-	A	A	A	-	-
Bromine2 (wet)	D	D	D	C	-	D	D	D	D	A	D	D	D	D
Butadiene	A	A	A	C	A	C	C	A	-	A	A	B	A	-
Butane2 1	A	A	A	A	A	C	C	A	D	A	A	B	D	D
Butanol	A	A	A	A	-	-	-	-	-	-	-	-	-	-
Butter	B	A	A	D	-	D	-	-	-	A	A	B	A	D
Buttermilk	A	A	A	D	-	D	-	A	-	A	A	A	-	D
Butylene	B	A	A	A	A	A	A	-	-	A	B	-	D	D
Butyl Acetate1	-	C	A	A	-	-	A	-	D	D	B	D	B	D
Butyric Acid1	B	A	B	C	-	D	-	D	A	D	D	D	B	-
Calcium Bisulfate	D	A	D	D	D	D	-	A	-	A	A	C	-	A
Calcium Bisulfide	-	B	C	C	-	-	-	A	A	A	A	A	D	-

Because we continually examine ways to improve our products, we reserve the right to alter specifications or discontinue products without prior notice.



Chemical Resistance Chart

RATINGS - CHEMICAL EFFECT

A: No effect - Excellent **B:** Minor effect - Good **C:** Moderate effect - Fair **D:** Severe effect - Not Recommended

	304 Stainless Steel	316 Stainless Steel	Aluminum	Cast Bronze	Brass	Cast Iron	Carbon Steel	Nylon	Polypropylene	Viton	Buna-N	Neoprene	EPDM	Natural Rubber	
Calcium Bisulfite	B	A	C	C	-	-	A	A	A	A	A	-	A	-	
Calcium Carbonate	A	A	C	C	-	D	-	A	A	A	A	A	-	A	
Calcium Chlorate	B	A	-	C	-	-	-	A	-	A	-	A	-	A	
Calcium Chloride	A	D	C	B	-	C	-	A	A	A	A	D	A	A	
Calcium Hydroxide	A	A	C	B	-	-	-	A	A	A	A	A	A	A	
Calcium Hypochlorite	D	C	C	D	-	D	-	D	A	A	B	D	A	A	
Calcium Sulfate	A	A	C	B	-	-	-	A	A	A	A	D	-	C	
Calgon	A	A	-	C	-	D	-	-	A	A	A	A	-	-	
Cane Juice2	A	A	B	B	C	A	-	A	D	-	A	A	-	A	
Carbolic Acid (See Phenol)	-	-	-	-	-	-	-	-	-	-	-	-	-	-	
Carbon Bisulfide2	A	A	A	C	-	B	-	A	D	A	D	D	D	D	
Carbon Dioxide (wet)	A	A	C	C	C	C	-	-	-	-	-	-	-	-	
CarbonDisulfide2	B	A	C	C	C	B	C	A	D	A	D	D	D	D	
Carbon Monoxide	A	A	A	-	-	-	-	A	A	A	A	B	A	C	
Carbon Tetrachloride2 1	B	B	C	C	A	C	D	A	D	A	C	D	-	D	
Carbonated Water	A	A	A	B	-	D	-	A	A	A	A	A	A	-	
Carbonic Acid	A	B	A	B	-	D	-	A	A	A	B	A	A	-	
Catsup	A	A	D	C	-	D	-	A	A	A	A	C	-	-	
Chloracetic Acid2	D	D	C	D	-	D	-	D	D	D	D	B	D	D	
Chloric Acid	D	D	-	-	-	-	-	-	-	-	D	D	-	-	
Chlorinated Glue	A	A	D	C	-	D	-	C	-	A	C	D	B	D	
Chlorine, Anhydrous Liquid	D	D	D	D	-	C	-	D	D	A	D	D	B	D	
Chlorine (dry)	A	D	D	A	B	A	-	-	D	-	D	-	D	-	
Chlorine Water	-	A	D	D	D	D	-	D	D	A	D	D	-	-	
Chlorobenzene (Mono)	A	A	B	B	-	B	C	A	D	A	D	D	D	D	
Chloroform	A	A	D	B	-	D	C	C	D	A	D	D	D	D	
Chlorosulfonic Acid1	D	-	D	D	-	-	D	D	D	D	D	D	D	D	
Chlorox (Bleach)	A	A	C	A	-	D	C	D	D	A	C	B	B	D	
Chocolate Syrup	A	A	A	-	-	D	-	A	A	A	A	A	A	-	D
Chromic Acid 5%	A	A	C	D	D	D	-	D	A	A	A	D	A	B	
Chromic Acid 10%	B	-	-	-	D	-	-	D	A	A	D	D	-	-	
Chromic Acid 30%	B	-	-	-	D	-	-	D	A	A	D	D	-	-	
Chromic Acid 50%	B	B	C	D	D	D	-	D	B	A	D	D	A	D	
Cider	A	A	B	A	-	D	-	-	A	A	A	-	-	-	
Citric Acid	A	A	C	D	C	D	-	C	B	A	D	A	A	A	
Citric Oils	A	A	C	B	-	-	-	-	A	A	A	D	-	-	
Coffee	A	A	A	B	-	C	-	A	A	A	A	A	-	A	
Copper Chloride	D	D	D	D	-	D	-	D	A	A	A	A	A	A	
Copper Cyanide	A	A	D	C	-	D	-	A	A	B	B	A	A	A	
Copper Florobate	D	D	D	D	-	D	-	-	A	B	A	-	A	-	
Copper Nitrate	A	A	D	D	-	-	D	A	A	A	A	-	-	-	
Copper Sulfate (5% Sol)	A	A	D	D	D	D	-	D	A	A	A	A	-	C	
Copper Sulfate	B	-	-	C	D	-	-	C	A	B	B	A	A	-	
Cream	A	A	A	C	-	D	-	A	A	A	A	C	-	-	
Cresols2	A	A	B	D	C	-	-	-	C	D	D	D	D	D	
Cresylic Acid	A	A	C	C	-	-	D	-	-	A	D	D	D	D	
Cyclohexane	A	-	A	A	-	-	A	-	D	A	A	D	D	D	
Cyanic Acid	A	-	-	-	-	-	-	-	-	C	D	-	-	-	
Detergents	A	A	A	A	-	-	A	A	A	A	A	B	A	C	
Dichlorethane	A	A	A	-	-	-	A	-	B	-	D	-	D	-	
Diesel Fuel	A	A	A	A	-	A	A	-	D	A	A	A	D	D	
Diethylamine	A	-	A	A	-	-	-	C	D	B	B	B	C	-	
Diethylene Glycol	A	-	-	A	-	-	-	A	-	A	A	A	A	A	
Diphenyl Oxide	A	-	-	A	-	-	-	-	A	D	D	D	D	D	

	304 Stainless Steel	316 Stainless Steel	Aluminum	Cast Bronze	Brass	Cast Iron	Carbon Steel	Nylon	Polypropylene	Viton	Buna-N	Neoprene	EPDM	Natural Rubber
Dyes	A	A	B	C	-	-	-	-	-	A	-	C	-	-
Epsom Salts (Magnesium Sulfate)	A	A	A	B	-	-	-	-	A	A	A	A	-	C
Ethane	A	-	A	A	-	-	-	-	-	A	A	B	D	D
Ethanolamine	A	A	-	-	-	-	C	-	-	D	B	B	-	C
Ether3	A	A	A	B	A	-	B	C	-	C	D	D	C	D
Ethyl Acetate2	A	A	B	B	-	-	C	A	C	D	D	D	B	D
Ethyl Chloride	A	A	B	B	-	C	D	A	D	A	D	C	A	A
Ethyl Sulfate	D	-	-	-	-	-	-	-	-	A	A	-	-	-
Ethylene Chloride2	A	A	C	A	-	C	C	-	D	A	D	D	C	D
Ethylene Dichloride	A	A	D	C	-	-	C	A	A	A	D	D	C	D
Ethylene Glycol4	A	A	B	B	B	C	A	A	A	A	A	A	A	A
Ethylene Oxide	-	A	A	A	-	-	A	-	-	D	D	D	C	D
Fatty Acids	A	A	B	C	-	D	-	A	A	A	C	B	C	C
Ferric Acid	D	D	D	D	D	D	-	D	A	A	D	B	A	A
Ferric Nitrate	A	A	D	D	-	-	D	A	A	A	A	A	A	A
Ferric Sulfate	A	C	D	D	D	D	-	A	A	A	B	A	-	A
Ferrous Chloride	D	D	D	C	-	D	-	D	A	A	B	A	-	A
Ferrous Sulfate	A	C	D	C	-	D	D	D	A	A	B	A	-	A
Fluoboric Acid	D	B	-	-	-	D	-	C	A	A	B	A	-	-
Fluorine	D	D	D	D	-	D	D	-	-	-	-	-	-	-
Fluosilicic Acid	-	B	D	-	-	D	-	D	A	B	A	A	-	-
Formaldehyde 40%	-	A	-	-	-	-	-	D	A	D	B	A	-	-
Formaldehyde	A	A	A	A	B	D	A	A	D	C	D	B	C	-
Formic Acid6	A	B	D	C	C	D	D	D	A	B	D	D	A	C
Freon 111	-	A	B	B	-	C	B	A	-	B	C	D	D	D
Freon 12 (wet)2	-	D	B	B	-	-	-	A	A	A	A	B	B	D
Freon 22	-	A	B	B	-	-	-	A	-	D	D	A	A	A
Freon 113	-	A	B	B	-	-	-	A	-	C	A	A	-	D
Freon T.F.4	-	A	B	B	-	-	-	A	D	B	A	A	D	D
Fruit Juice	A	A	B	B	-	D	D	A	A	A	A	A	-	-
Fuel Oils	A	A	A	B	-	C	B	A	B	A	A	B	D	D
Furan Resin	A	A	A	A	-	A	A	-	A	D	D	-	D	-
Furfural1	A	A	A	A	-	-	A	A	D	D	D	B	D	-
Gallic Acid	A	A	A	A	-	D	D	A	-	B	A	-	-	-
Gasoline1 4	A	A	A	A	-	A	A	A	C	A	A	D	C	D
Gelatin	A	A	A	A	C	D	D	A	A	A	A	A	A	A
Glucose	-	A	A	A	A	B	B	A	A	A	A	A	A	A
Glue P.V.A.1	B	A	B	A	-	-	A	A	-	A	A	A	-	-
Glycerine	A	A	A	A	B	B	B	A	A	A	A	A	A	A
Glycolic Acid	-	-	-	-	-	-	-	-	A	A	A	A	-	-
Gold Monocyanide	-	A	-	A	-	D	-	-	-	A	A	A	-	-
Grape Juice	A	A	B	B	-	D	-	-	-	A	A	A	-	-
Grease4	A	A	A	B	-	A	A	-	A	A	D	-	-	-
Heptane1	-	A	A	A	-	-	B	A	D	A	A	B	D	-
Hexane1	A	A	A	B	-	-	B	A	C	A	A	B	D	D
Honey	A	A	A	A	-	A	-	A	A	A	A	A	A	-
Hydraulic Oils (Petroleum)1	A	A	A	B	-	A	A	A	D	A	A	B	D	D
Hydraulic Oils (Synthetic)1	A	A	A	A	-	A	-	A	D	A	C	-	-	-
Hydrazine	A	A	-	-	-	C	-	-	-	A	B	B	A	C
Hydrobromic Acid 20%	-	D	-	-	-	-	-	D	A	A	D	C	-	-
Hydrobromic Acid4	D	D	D	D	-	D	D	D	B	A	D	D	A	A
Hydrochloric Acid (Dry Gas)	C	A	D	-	-	-	D	-	-	-	-	-	A	-
Hydrochloric Acid 20%4	D	D	D	D	-	D	-	D	A	A	C	C	A	C

Because we continually examine ways to improve our products, we reserve the right to alter specifications or discontinue products without prior notice.



Chemical Resistance Chart

RATINGS - CHEMICAL EFFECT

A: No effect - Excellent **B:** Minor effect - Good **C:** Moderate effect - Fair **D:** Severe effect - Not Recommended

	304 Stainless Steel	316 Stainless Steel	Aluminum	Cast Bronze	Brass	Cast Iron	Carbon Steel	Nylon	Polypropylene	Viton	Buna-N	Neoprene	EPDM	Natural Rubber	
Hydrochloric Acid 37%4	D	D	D	D	-	D	-	D	-	D	A	C	C	C	D
Hydrochloric Acid 100%	D	D	D	D	-	D	-	D	-	C	D	C	-	A	
Hydrocyanic Acid	A	A	A	D	D	-	C	A	A	A	C	B	-	A	
Hydrocyanic Acid (Gas 10%)	D	D	-	-	-	-	-	-	-	-	-	C	A	C	
Hydrofluoric Acid 20%1	D	D	D	D	-	D	-	D	A	A	D	C	A	C	
Hydrofluoric Acid 75%1 2	C	D	D	D	-	D	-	D	B	A	D	D	C	C	
Hydrofluoric Acid 100%	D	D	D	D	-	D	-	-	-	D	D	-	D	-	D
Hydrofluosilicic Acid 20%	D	D	D	A	-	D	-	D	A	A	B	B	A	A	
Hydrofluosilicic Acid	D	D	C	D	-	-	-	-	-	-	-	A	-	-	
Hydrogen Gas	A	A	A	A	-	B	B	-	-	A	-	-	-	-	
Hydrogen Peroxide 10%	C	C	A	D	D	D	-	D	-	-	A	D	-	C	
Hydrogen Peroxide 30%	-	B	-	-	D	-	-	D	A	A	D	C	-	-	
Hydrogen Peroxide	A	B	A	D	D	D	D	A	A	D	D	C	D	C	
Hydrogen Sulfide, Aqueous Solution	D	A	C	D	C	D	-	D	A	D	C	B	A	D	
Hydrogen Sulfide (dry)	C	A	D	D	C	B	B	D	-	D	-	-	-	A	
Hydroxyacetic Acid (70%)	-	-	D	-	-	-	-	-	-	A	A	A	A	-	
Ink	A	A	C	C	-	D	D	A	-	A	A	A	A	-	
Iodine	D	D	D	D	-	D	-	D	A	B	D	B	D		
Iodine (in Alcohol)	-	B	-	-	-	-	-	D	B	A	D	D	-	-	
Iodoform	C	A	A	C	-	C	B	A	-	A	-	-	-	-	
Isotane2	-	-	A	-	-	-	-	-	D	A	-	-	-	D	
Isopropyl Acetate	-	B	C	-	-	-	-	-	-	D	D	B	D		
Isopropyl Ether2	-	A	A	C	-	-	A	-	D	D	B	D	D	D	
Jet Fuel (JP#, JP4, JP5)	A	A	A	A	-	A	A	A	D	A	A	D	D	D	
Kerosene2	A	A	A	A	A	A	B	A	D	A	A	D	A	D	
Ketones	A	A	B	A	-	A	A	A	D	D	D	D	D	C	
Lacquers	A	A	A	A	C	C	C	A	A	D	D	D	D	-	D
Lacquer Thinners	-	A	-	-	C	-	-	A	B	-	D	D	A	-	
Lactic Acid	A	B	C	D	-	D	D	C	A	B	B	A	B	A	
Lard	A	A	A	A	-	A	C	A	A	A	A	B	-	D	
Latex	A	A	A	A	-	-	-	A	-	A	A	C	A	-	
Lead Acetate	A	A	D	C	-	-	D	A	D	B	D	A	A		
Lead Sulfamate	-	-	-	-	-	-	-	-	A	A	B	A	D	C	
Ligroin3	-	A	-	A	-	-	-	-	D	A	A	B	A	D	
Lime	A	A	C	A	-	A	-	-	-	A	A	B	D	-	
Lubricants	A	A	A	B	-	-	-	A	A	A	A	D	-	D	
Magnesium Carbonate	A	A	-	-	-	-	-	-	A	-	A	A	A	-	
Magnesium Chloride	B	B	D	B	C	D	C	A	A	A	A	A	A	A	
Magnesium Hydroxide	A	A	D	C	B	B	B	A	A	A	B	B	-	C	
Magnesium Nitrate	A	A	-	-	-	-	-	A	A	A	A	A	-	-	
Magnesium Oxide	A	A	-	-	-	-	-	-	-	A	A	A	-	-	
Magnesium Sulfate	B	A	B	B	B	C	B	A	A	A	A	A	D	C	
Maleic Acid	A	A	B	C	-	-	B	A	C	A	D	A	D	D	
Maleic Anhydride	-	-	-	-	-	-	-	-	-	A	D	D	-	D	
Malic Acid	A	A	C	D	-	-	D	A	-	B	-	A	-	A	
Mash	A	A	-	A	-	-	-	-	-	A	A	-	-	-	
Mayonnaise	A	A	D	D	-	D	D	A	A	A	A	-	-	-	
Melamine	D	D	-	D	-	-	-	-	-	C	-	-	-	-	
Mercuric Chloride (Dilute Solution)	D	D	D	D	D	D	A	A	A	A	A	A	A	A	
Mercuric Cyanide	A	A	D	D	-	-	D	-	A	-	A	-	-	-	
Mercury	A	A	C	D	D	A	A	A	A	A	A	A	A	A	
Methanol (See Alcohol)															
Methyl Acetate	-	A	A	A	-	-	B	-	-	D	D	B	B	D	

	304 Stainless Steel	316 Stainless Steel	Aluminum	Cast Bronze	Brass	Cast Iron	Carbon Steel	Nylon	Polypropylene	Viton	Buna-N	Neoprene	EPDM	Natural Rubber	
Methyl Acrylate	-	-	-	-	-	-	-	-	-	-	D	D	B	B	D
Methyl Acetone	-	A	A	A	-	A	A	-	-	D	D	D	-	-	
Methyl Alcohol 10%	-	A	C	C	-	-	B	A	-	-	B	-	-	A	
Methyl Bromide	-	-	-	-	-	-	-	-	-	A	B	D	D	D	
Methyl Butyl Ketone	-	A	A	-	-	-	-	-	-	D	D	D	A	D	
Methyl Cellosolve	-	-	A	A	-	-	-	-	-	A	D	D	D	B	D
Methyl Chloride	A	A	D	A	-	-	-	A	A	D	A	D	D	C	D
Methyl Dichloride	-	-	-	-	-	-	-	-	-	A	D	D	D	D	
Methyl Ethyl Ketone	A	A	A	A	-	-	-	A	A	D	D	D	A	D	
Methyl Isobutyl Ketone2	-	A	-	-	-	-	-	A	C	D	D	D	C	D	
Methyl Isopropyl Ketone	-	A	-	-	-	-	-	A	-	D	D	D	B	D	
Methyl Methacrylate	-	-	-	-	-	-	-	-	-	D	D	D	D	D	
Methylamine	-	A	A	D	-	B	B	-	-	-	B	-	-	-	
Methylene Chloride	A	A	A	A	C	-	B	D	D	D	D	D	D	D	
Milk	A	A	A	C	C	D	D	A	A	A	A	A	A	A	
Molasses	A	A	A	A	B	A	A	A	A	A	A	A	-	-	
Mustard	A	A	B	B	-	C	B	A	A	A	B	C	-	-	
Naptha	A	A	A	B	-	B	B	A	A	B	A	B	D	D	
Napthalene	A	B	B	C	-	B	A	-	B	B	D	D	D	D	
Nickel Chloride	A	B	D	D	-	D	-	A	A	A	A	A	A	A	
Nickel Sulfate	A	B	D	C	C	D	D	A	A	A	A	A	A	C	
Nitric Acid (10% Solution)	A	A	D	D	-	D	D	D	A	A	D	D	B	D	
Nitric Acid (20% Solution)	A	A	D	D	-	D	-	D	A	A	D	D	D	D	
Nitric Acid (50% Solution)	A	A	D	D	-	D	-	D	D	A	D	D	D	D	
Nitric Acid (Concentrated Solution)	D	B	B	D	D	D	-	D	D	B	D	D	D	D	
Nitrobenzene2	A	B	C	D	-	B	B	C	C	D	D	D	D	D	
Oils Aniline	A	A	C	A	-	A	-	C	A	A	D	D	D	B	D
Anise	A	A	A	-	-	-	-	-	-	-	-	-	D	-	
Bay	A	A	-	-	-	-	-	-	-	A	-	D	-	-	
Bone	A	A	-	A	-	-	-	-	-	A	A	D	-	-	
Castor	A	A	A	A	-	A	-	-	-	A	A	A	B	A	
Cinnamon	A	A	-	-	-	-	-	-	A	D	-	D	-	-	
Citric	A	A	-	D	-	D	-	A	A	A	A	D	-	-	
Clove	A	A	-	-	-	-	-	A	B	-	A	-	-	-	
Coconut	A	A	B	A	-	A	-	A	A	A	A	A	A	D	
Cod Liver	A	A	B	-	-	-	-	A	A	A	A	B	A	D	
Corn	A	A	B	B	-	A	-	A	A	A	A	D	C	D	
Cotton Seed	A	A	B	B	-	A	C	A	A	A	A	B	C	D	
Cresote2	A	A	A	-	-	-	-	D	A	A	B	D	D		
Diesel Fuel (2D, 3D, 4D, 5D)	A	A	A	A	-	-	-	A	A	A	A	D	D	D	
Fuel (1,2,3,5A, 5B, 6)	A	A	A	A	-	-	-	-	B	A	B	D	D	D	
Oils (Cont.) Ginger	A	A	-	-	-	-	-	-	A	A	A	-	-	-	
Hydraulic (See Hydraulic)															
Lemon	A	A	-	-	-	-	-	-	D	A	-	D	-	-	
Linseed	A	A	A	A	-	A	-	A	A	A	A	D	D	D	
Mineral	A	A	A	A	-	A	B	A	B	A	A	B	D	D	
Olive	A	A	A	B	-	A	B	A	A	A	A	B	-	D	
Orange	A	A	-	-	-	-	-	A	A	A	A	D	-	-	
Palm	A	A	A	B	-	-	-	A	-	A	A	D	-	-	
Peanut3	A	A	A	A	-	A	-	-	D	A	A	D	-	D	
Peppermint2	A	A	-	A	-	-	-	-	D	A	D	D	-	-	
Pine	A	A	A	D	-	C	B	-	-	A	A	D	-	D	
Rape Seed	A	A	-	A	-	-	-	-	-	A	B	D	-	D	

Because we continually examine ways to improve our products, we reserve the right to alter specifications or discontinue products without prior notice.



Chemical Resistance Chart

RATINGS - CHEMICAL EFFECT

A: No effect - Excellent **B:** Minor effect - Good **C:** Moderate effect - Fair **D:** Severe effect - Not Recommended

	304 Stainless Steel	316 Stainless Steel	Aluminum	Cast Bronze	Brass	Cast Iron	Carbon Steel	Nylon	Polypropylene	Viton	Buna-N	Neoprene	EPDM	Natural Rubber
Rosin	A	A	A	-	-	-	-	A	A	A	-	-	-	-
Sesame Seed	A	A	A	A	-	A	-	-	-	A	A	D	-	-
Silicone	A	A	-	A	-	A	-	A	A	A	A	-	A	-
Soybean	A	A	A	B	-	A	-	A	A	A	A	D	-	D
Sperm	A	A	-	A	-	-	-	-	A	A	D	-	-	-
Tanning	A	A	-	-	-	-	-	-	A	A	D	-	-	-
Turbine	A	A	A	A	-	A	-	-	-	A	A	D	-	D
Oleic Acid	A	A	B	B	C	C	C	A	C	D	B	D	D	D
Oleum 25%	-	-	-	-	-	-	-	-	A	D	D	D	-	-
Oleum	-	A	B	C	C	-	B	-	D	A	C	D	D	D
Oxalic Acid (Cold)	A	B	C	B	C	D	D	D	A	A	B	B	A	C
Paraffin	A	A	A	A	-	B	B	A	A	A	A	-	-	-
Pentane	C	C	A	A	-	B	B	A	-	A	A	B	D	D
Perchloroethylene2	A	A	A	C	-	B	B	-	D	A	C	D	D	D
Petrolatum	-	A	B	B	-	C	C	A	-	A	A	B	A	D
Phenol 10%	A	A	A	C	-	B	D	D	-	B	D	C	D	C
Phenol (Carbolic Acid)	A	A	B	B	D	D	D	D	B	A	D	D	D	D
Phosphoric Acid (to 40% Solution)	B	A	D	D	D	D	-	D	A	A	D	D	B	C
Phosphoric Acid (40-100% Solution)	C	B	D	D	D	D	-	D	A	A	D	D	B	C
Phosphoric Acid (Crude)	D	C	D	D	D	D	D	-	A	D	D	B	-	-
Phosphoric Anhydride (Dry or Moist)	A	A	-	-	D	-	-	-	D	D	D	-	A	-
Phosphoric Anhydride (Molten)	A	A	D	D	D	-	-	A	-	D	C	D	-	D
Photographic (Developer)	C	A	C	-	-	D	-	-	A	A	A	A	-	-
Phthalic Anhydride	A	B	B	B	-	C	C	A	-	A	C	-	-	-
Picric Acid	A	A	C	D	D	D	D	A	-	A	A	A	-	A
Plating Solutions Antimony Plating 130°F	-	A	-	-	-	-	-	D	A	A	A	A	-	-
Arsenic Plating 110°F	-	A	-	-	-	-	-	-	A	A	A	A	-	-
Brass Plating Regular Brass Bath 100°F	-	A	-	-	-	-	-	-	A	A	A	A	-	-
High Speed Brass Bath 110°F	-	A	-	-	-	-	-	-	A	A	A	A	-	-
Bronze Plating Copper-Cadmium Bronze Bath R.T.	-	A	-	-	-	-	-	-	A	A	A	A	-	-
Copper-Tin Bronze Bath 160°F	-	A	-	-	-	-	-	-	A	A	A	B	-	-
Platings (Cont.) Copper-Zinc Bronze Bath 100°F	-	A	-	-	-	-	-	-	A	A	A	A	-	-
Cadmium Plating Cyanide Bath 90°F	-	A	-	-	-	-	-	-	A	A	A	A	-	-
Fluoborate Bath 100°F	-	A	-	-	-	-	-	-	D	A	A	B	C	-
Chromium Plating Chromic-Sulfuric Bath 130°F	-	C	-	-	-	-	-	-	D	A	C	D	D	-
Fluosilicate Bath 95°F	-	C	-	-	-	-	-	-	D	A	C	D	D	-
Fluoride Bath 130°F	-	D	-	-	-	-	-	-	D	A	C	D	D	-
Black Chrome Bath 115°F	-	C	-	-	-	-	-	-	D	A	C	D	D	-
Barrel Chrome Bath 95°F	-	D	-	-	-	-	-	-	D	A	C	D	D	-
Copper Plating (Cyanide) Copper Strike Bath 120°F			A	-	-	-				B	-	A	-	-
Rochelle Salt Bath 150°F	-	A	-	-	-	-	-	-	A	A	A	A	B	-
High Speed Bath 180°F	-	A	-	-	-	-	-	-	A	A	A	A	B	-

	304 Stainless Steel	316 Stainless Steel	Aluminum	Cast Bronze	Brass	Cast Iron	Carbon Steel	Nylon	Polypropylene	Viton	Buna-N	Neoprene	EPDM	Natural Rubber
Copper Plating (Acid) Copper Sulfate Bath R.T.	-	D	-	-	-	-	-	D	A	A	A	A	-	-
Copper Fluoborate Bath 120°F	-	D	-	-	-	-	-	D	A	A	B	C	-	-
Copper (Misc.) Copper Pyrophosphate 140°F	-	A	-	-	-	-	-	A	A	A	A	A	-	-
Copper (Electroless) 140°F	-	-	-	D	-	-	-	A	A	A	D	D	-	-
Gold Plating Cyanide 150°F	-	A	-	C	-	-	-	A	A	A	A	A	-	-
Neutral 75°F Acid 75°F	-	C	-	-	-	-	-	A	A	A	A	A	-	-
Indium Sulfamate Plating R.T.	-	C	-	-	-	-	-	D	A	A	A	A	-	-
Iron Plating Ferrous Chloride Bath 190°F	-	D	-	-	-	-	-	D	C	A	B	D	-	-
Ferrous Sulfate Bath 150°F	-	C	-	-	-	-	-	D	A	A	A	B	-	-
Ferrous Am. Sulfate Bath 150°F	-	C	-	-	-	-	-	D	A	A	A	B	-	-
Sulfate-Chloride Bath 160°F	-	D	-	-	-	-	-	D	A	A	B	C	-	-
Fluoborate Bath 145°F	-	D	-	-	-	-	-	D	A	A	B	C	-	-
Sulfamate 140°F	-	D	-	-	-	-	-	D	A	A	A	A	-	-
Lead Fluoborate Plating	-	C	-	-	-	-	-	D	A	A	B	C	-	-
Nickel Plating Watts Type 115-160°F	-	C	-	-	-	-	-	A	A	A	A	A	-	-
High Chloride 130-160°F	-	C	-	-	-	-	-	D	A	A	A	B	-	-
Fluoborate 100-170°F	-	C	-	D	-	-	-	D	A	A	B	C	-	-
Sulfamate 100-140°F	-	C	-	-	-	-	-	D	A	A	A	A	-	-
Electroless 200°F	-	-	-	-	-	-	-	D	D	A	D	D	-	-
Rhodium Plating 120°F	-	D	-	-	-	-	-	D	A	A	A	B	-	-
Silver Plating 80-120°F	-	A	-	-	-	-	-	A	A	A	A	A	-	-
Tin-Fluoborate Plating 100°F	-	C	-	-	-	-	-	D	A	A	B	C	-	-
Tine-Lead Plating 100°F	-	C	-	-	-	-	-	D	A	A	B	C	-	-
Zinc Plating Acid Chloride 140°F	-	D	-	-	-	-	-	D	A	A	A	A	-	-
Acid Sulfate Bath 150°F	-	C	-	-	-	-	-	D	A	A	A	B	-	-
Platings (Cont'd) Acid Fluoborate Bath R.T.	-	-	-	-	-	-	-	D	A	A	B	C	-	-
Alkaline Cyanide Bath R.T.	-	-	-	-	-	-	-	A	A	A	A	A	-	-
Potash	A	-	C	C	-	B	-	A	A	A	A	B	-	B
Potassium Bicarbonate	A	-	C	B	-	D	-	A	A	A	A	A	-	B
Potassium Bromide	A	-	C	C	-	D	D	C	A	A	A	A	A	B
Potassium Carbonate	A	-	C	C	-	B	B	A	A	A	A	B	-	B
Potassium Chlorate	A	A	B	B	-	B	B	D	A	A	A	A	-	B
Potassium Chloride	A	A	B	C	C	B	B	B	A	A	A	A	A	A
Potassium Chromate	-	B	A	A	-	A	-	-	A	A	A	-	B	-
Potassium Cyanide Solutions	A	B	D	D	-	B	B	A	A	B	A	A	A	A
Potassium Dichromate	A	A	A	C	-	B	C	D	A	B	A	A	A	A
Potassium Ferrocyanide	A	-	C	A	-	-	C	A	-	-	D	-	-	A
Potassium Hydroxide (50%)	B	B	D	D	D	C	A	A	A	D	B	A	A	C
Potassium Nitrate	A	B	B	B	-	-	B	C	A	B	A	A	A	A
Potassium Permanganate	A	B	B	B	-	B	B	D	B	B	A	A	-	B

Because we continually examine ways to improve our products, we reserve the right to alter specifications or discontinue products without prior notice.



Chemical Resistance Chart

RATINGS - CHEMICAL EFFECT

A: No effect - Excellent **B:** Minor effect - Good **C:** Moderate effect - Fair **D:** Severe effect - Not Recommended

	304 Stainless Steel	316 Stainless Steel	Aluminum	Cast Bronze	Brass	Cast Iron	Carbon Steel	Nylon	Polypropylene	Viton	Buna-N	Neoprene	EPDM	Natural Rubber
Potassium Sulfate	A	B	A	B	B	B	B	C	A	A	A	A	A	C
Potassium Sulfide	A	-	B	B	-	B	B	-	-	-	-	-	-	-
Propane (Liquified)1 2	A	-	A	A	A	-	B	A	D	A	A	B	D	D
Propylene Glycol	B	-	A	B	-	B	B	B	-	A	A	C	-	-
Pyridine	C	-	B	-	-	B	A	-	B	D	D	D	B	D
Pyrogallic Acid	A	A	B	B	-	B	B	A	-	A	A	-	-	-
Rosins	A	A	A	A	C	-	C	A	A	A	-	A	-	-
Rum	A	-	-	-	-	-	-	A	A	A	A	A	-	-
Rust Inhibitors	A	-	-	A	-	A	-	-	A	A	A	C	-	-
Salad Dressing	A	-	B	B	-	D	-	A	A	A	A	-	-	-
Sea Water	A	C	C	C	-	-	D	A	A	A	A	B	A	A
Shellac (Bleached)	A	-	A	A	B	B	A	A	A	-	A	-	-	-
Shellac (Orange)	A	-	A	A	C	C	A	A	A	-	A	-	-	-
Silicone	B	-	B	A	-	-	-	A	A	A	A	A	A	A
Silver Bromide	C	C	D	-	-	-	-	-	-	-	-	-	-	-
Silver Nitrate	A	B	D	D	-	D	D	A	A	A	C	A	C	A
Soap Solutions	A	A	C	B	-	B	A	A	A	A	A	B	-	C
Soda Ash (See Sodium Carbonate)														
Sodium Acetate	A	A	B	B	-	C	C	A	A	D	D	C	-	A
Sodium Aluminate	-	-	C	B	-	-	C	A	-	A	A	A	A	B
Sodium Bicarbonate	A	A	A	B	A	C	C	A	A	A	A	A	A	A
Sodium Bisulfate	A	-	D	C	C	D	D	C	A	B	A	A	-	A
Sodium Bisulfate	A	-	A	C	-	D	-	D	A	A	A	A	-	A
Sodium Borate	A	-	C	A	-	C	C	A	-	A	-	A	-	-
Sodium Carbonate	A	B	C	B	B	B	B	A	A	A	A	A	A	A
Sodium Chlorate	A	-	B	B	-	-	C	A	A	A	D	A	-	A
Sodium Chloride	A	C	C	B	C	B	C	A	A	A	A	A	A	B
Sodium Chromate	A	A	D	B	-	B	B	A	A	B	A	A	-	-
Sodium Cyanide	A	-	D	D	D	B	B	C	A	A	A	A	A	A
Sodium Fluoride	C	-	C	C	-	D	D	A	-	B	D	D	-	D
Sodium Hydrosulfite	-	-	A	C	-	-	-	A	-	A	-	A	-	A
Sodium Hydroxide (20%)	A	A	D	C	D	A	-	C	A	A	A	B	A	A
Sodium Hydroxide (50% Solution)	A	B	D	C	D	B	-	C	A	D	D	C	-	A
Sodium Hydroxide (80% Solution)	A	D	D	C	D	C	-	C	A	B	D	C	-	B
Sodium Hypochlorite (to 20%)	C	C	C	D	D	D	-	A	D	A	C	D	B	C
Sodium Hypochlorite	-	A	D	D	-	D	D	A	A	B	B	A	-	-
Sodium Hyposulfate	A	A	D	D	-	-	-	-	-	-	-	C	-	C
Sodium Metaphosphate2	-	A	A	C	C	B	B	A	D	A	A	B	A	A
Sodium Metasilicate	-	A	B	B	-	C	C	-	-	A	A	A	-	-
Sodium Nitrate	A	A	A	B	C	A	B	A	A	D	C	B	A	C
Sodium Perborate	-	C	B	C	C	B	B	A	A	A	B	B	A	C
Sodium Peroxide	A	A	C	C	C	D	C	D	-	A	C	B	A	C
Sodium Polyphosphate (Mono, Di, Tribasic)	A	A	D	C	-	-	-	-	A	A	D	A	A	A
Sodium Silicate	A	B	C	C	C	-	B	A	A	A	A	A	A	A
Sodium Sulfate	A	A	B	B	B	A	B	A	A	A	A	A	A	C
Sodium Sulfide	A	B	D	D	D	A	B	A	A	A	C	A	A	C
Sodium Sulfide	C	C	C	C	-	A	-	D	-	A	A	A	-	A
Sodium Tetraborate	-	A	-	-	-	-	-	-	A	A	-	-	-	-
Sodium Thiosulphate ("Hypo")	A	A	B	D	D	C	B	A	A	A	B	A	A	C

	304 Stainless Steel	316 Stainless Steel	Aluminum	Cast Bronze	Brass	Cast Iron	Carbon Steel	Nylon	Polypropylene	Viton	Buna-N	Neoprene	EPDM	Natural Rubber
Sorghum	A	A	-	-	-	A	-	A	-	A	A	A	-	-
Soy Sauce	A	A	A	-	D	-	A	-	A	A	A	A	-	D
Stannic Chloride	D	D	D	D	-	D	D	A	A	A	A	A	A	A
Stannic Fluoborate	-	A	-	-	-	D	-	-	-	A	A	A	-	-
Stannous Chloride	D	C	D	D	-	D	D	D	-	B	C	D	-	A
Starch	A	A	A	B	-	C	C	A	-	A	A	A	-	-
Stearic Acid2	A	A	B	C	C	C	C	A	D	A	B	B	B	C
Stoddard Solvent	A	A	A	A	A	B	B	A	D	A	B	D	D	D
Styrene	A	A	A	A	-	-	A	-	-	B	D	D	D	D
Sugar (Liquids)	A	A	A	A	-	B	B	A	A	A	A	B	-	A
Sulfate Liquors	C	C	B	C	-	-	-	-	A	-	-	C	-	-
Sulfur Chloride	D	D	D	C	D	-	-	A	D	A	D	D	D	D
Sulfur Dioxide2	A	A	A	B	-	-	-	D	D	D	B	A	D	A
Sulfur Dioxide (dry)	A	A	A	A	C	A	B	A	-	D	-	D	-	D
Sulfur Trioxide (dry)	A	C	A	B	-	B	B	D	-	A	D	D	B	C
Sulfuric Acid (to 10%)	D	C	C	D	D	D	-	D	A	A	C	D	D	C
Sulfuric Acid 10%-75%2	D	D	D	D	D	D	-	D	A	A	D	D	D	D
Sulfuric Acid 75%-100%	-	D	-	D	-	D	-	D	B	A	D	D	-	-
Sulfurous Acid	C	B	C	C	D	-	D	D	A	A	C	B	B	C
Sulfuryl Chloride	-	-	-	-	-	-	-	-	-	-	-	-	-	-
Syrup	A	A	A	D	-	-	-	A	A	A	A	B	-	A
Tallow	A	A	A	-	-	-	-	A	A	A	A	B	-	A
Tannic Acid	A	A	C	B	-	C	C	D	A	A	D	A	A	A
Tanning Liquors	A	A	C	A	-	-	-	-	A	A	C	-	-	-
Tartaric Acid	A	B	C	A	C	D	D	A	A	A	D	A	-	A
Tetrachlorethane	-	A	-	-	-	-	-	A	A	A	D	-	D	D
Tetrahydrofuran	A	A	D	D	-	D	A	A	C	D	D	D	B	D
Toluene, Toluol3	A	A	A	A	A	A	A	A	D	C	D	D	D	D
Tomato Juice	A	A	A	C	-	C	C	A	A	C	A	D	A	-
Trichlorethane	C	A	C	C	-	C	-	-	-	A	D	D	D	D
Trichlorethylene2	A	A	B	B	A	C	B	C	D	A	D	D	D	D
Trichloropropane	-	A	-	A	-	-	-	-	-	A	A	A	-	-
Tricresylphosphate	-	A	-	A	-	-	-	-	-	B	D	D	A	-
Triethylamine	-	-	-	A	-	-	-	-	-	A	A	B	-	-
Turpentine3	A	A	C	B	C	B	B	A	B	A	D	D	D	D
Urine	A	A	B	C	-	B	-	A	A	A	D	A	-	-
Vegetable Juice	A	A	A	C	-	D	-	A	-	A	A	D	-	D
Vinegar	A	A	D	B	B	C	D	A	-	A	C	-	-	-
Varnish (Use Viton for Aromatic)	A	A	A	A	B	-	C	A	A	A	B	D	-	D
Water, Acid, Mine	A	A	C	C	D	C	-	A	A	A	A	B	-	B
Water, Distilled, Lab Grade 7	A	A	B	A	-	D	-	A	A	A	A	B	A	A
Water, Fresh	A	A	A	A	C	B	D	A	A	A	A	B	A	A
Water, Salt	A	A	B	B	C	D	-	A	A	A	A	B	A	A
Weed Killers	A	A	C	C	-	-	-	A	-	A	B	C	-	-
Whey	A	A	B	-	-	-	-	-	-	A	A	-	-	-
Whiskey & Wines	A	A	D	B	B	D	D	A	A	A	A	A	A	A
White Liquor (Pulp Mill)	A	A	-	D	-	C	-	A	A	A	A	A	-	-
White Water (Paper Mill)	A	A	-	A	-	-	-	A	A	A	A	-	A	-
Xylene2	A	A	A	A	A	B	A	D	A	D	D	D	D	D
Zinc Chloride	D	B	D	D	D	D	D	A	A	A	A	A	A	A
Zinc Hydrosulphite	-	A	D	D	-	D	-	-	-	-	A	A	A	-
Zinc Sulfate	A	A	D	B	C	C	D	A	A	A	A	A	A	C

Because we continually examine ways to improve our products, we reserve the right to alter specifications or discontinue products without prior notice.

Cautionary Statement

All Products sold and distributed by Kuriyama of America, Inc. are in the nature of commodities and they are sold by published specifications and not for particular purposes, uses or applications. Purchaser shall first determine their suitability for the intended purposes, uses or applications and shall either conduct its own engineering studies or tests, or retain qualified engineers, consultants or testing laboratories and consult with them before determining the proper use, suitability or propriety of the merchandise or Products for the intended purposes, uses or applications.

Kuriyama of America, Inc. ("Seller") does not recommend the Products for any particular purpose, use or application, and the Purchaser or user thereof shall assume full responsibility for the suitability, propriety, use and application of the Products. Purchaser shall follow all instructions contained in Seller's catalogs, brochures, technical bulletins and other documents regarding the Products. The Products, including but not limited to, hose, tubing or couplings, may fail due to the use or conveyance of substances at elevated or lowered temperatures or at excessive pressure, the conveyance of abrasive, injurious, flammable, explosive or damaging substances.

Hose or tubing used in bent configurations will be subjected to increased abrasion. Hose clamps or couplings may loosen after initial installation and all sections of hose and tubing including connections, couplings, clamps, conductivity and bonding should be inspected frequently, regularly and consistently, and should be replaced, adjusted or re-tightened for the avoidance of leakage, for the prevention of injuries or damages, and for general safety purposes. Except as indicated in its Limited Warranty, Seller shall not be liable or responsible for direct or indirect injuries or damages caused by or attributed to the failure or malfunction of any Products sold or distributed by it.

Purchasers or users of the Products should frequently and consistently undertake inspections and protective measures with respect to the use and application of Products, which should include the examination of tube and cover, conditions of the hose or tubing, and the identification, repair or replacement of sections showing cracking, blistering, separations, internal and external abrasions, leaking or slipped couplings or connections and make proper proof tests.

Limited Warranty

The Products sold or distributed by Seller are warranted to its customers to be free from defects in material and workmanship at the time of shipment by us, subject to the following provisions. ALL WARRANTY CLAIMS SHALL BE MADE WITHIN SIX (6) MONTHS AFTER SELLER SHIPPED THE PRODUCTS. SELLER'S LIABILITY HEREUNDER IS LIMITED AT SELLER'S EXCLUSIVE DISCRETION, TO 1) THE PURCHASE PRICE OF ANY PRODUCTS PROVING DEFECTIVE; 2) REPAIR OF ANY DEFECTIVE PRODUCT OR PART THEREOF; OR 3) REPLACEMENT OF ANY DEFECTIVE PRODUCT OR PART UPON ITS AUTHORIZED RETURN TO SELLER.

THIS WARRANTY IS IN LIEU OF AND EXCLUDES ALL OTHER WARRANTIES, EXPRESSED, IMPLIED, STATUTORY, OR OTHERWISE CREATED UNDER APPLICABLE LAW INCLUDING, BUT NOT LIMITED TO, THE WARRANTY OF MERCHANTABILITY AND THE WARRANTY OF FITNESS FOR A PARTICULAR PURPOSE. IN NO EVENT SHALL SELLER OR THE MANUFACTURER OF THE PRODUCT BELIEVABLE FOR SPECIAL, INCIDENTAL, OR CONSEQUENTIAL DAMAGES, INCLUDING LOSS OF PROFITS, WHETHER OR NOT CAUSED BY OR RESULTING FROM THE NEGLIGENCE OF SELLER AND/OR THE MANUFACTURER OF THE PRODUCT, UNLESS SPECIFICALLY PROVIDED HEREIN. IN ADDITION, THIS WARRANTY SHALL NOT APPLY TO ANY PRODUCTS OR PORTIONS THEREOF WHICH HAVE BEEN SUBJECT TO ABUSE, MISUSE, IMPROPER INSTALLATION, MAINTENANCE, OR OPERATION, ELECTRICAL FAILURE OR ABNORMAL CONDITIONS, AND TO PRODUCTS WHICH HAVE BEEN TAMPERED WITH, ALTERED, MODIFIED, REPAIRED, REWORKED BY ANYONE NOT APPROVED BY SELLER, OR USED IN ANY MANNER INCONSISTENT WITH THE PROVISIONS OF THE "CAUTIONARY STATEMENT" ABOVE OR ANY INSTRUCTIONS OR SPECIFICATIONS PROVIDED WITH OR FOR THE PRODUCT. 09/17/18 REV

Distributed by:



Kuriyama of America, Inc.

Headquarters, Sales Office and Warehouse Location

360 E. State Parkway, Schaumburg, IL 60173-5335

Phone: (847) 755-0360 • Toll-free FAX: (800) 800-0320

International FAX: (847) 885-0996

Web Site: www.kuriyama.com

E-Mail: sales@kuriyama.com



Visit us
www.kuriyama.com
on the Web!



The trademarks contained in this publication are trademarks of Kuriyama of America, Inc.

CONTACT OUR SALES/WAREHOUSE LOCATIONS BELOW WHICH SERVE YOUR AREA

SOUTHWEST WAREHOUSE KURIYAMA OF AMERICA, INC. HOUSTON

200 PORTWALL STREET, SUITE 100
HOUSTON, TX 77029
Phone: (713) 674-8212
Toll Free Phone: (800) 501-6808
FAX: (713) 674-5214
Toll Free FAX: (800) 800-5214

WESTERN WAREHOUSE KURIYAMA OF AMERICA, INC. SANTA FE SPRINGS

10749 SHOEMAKER AVENUE
SANTA FE SPRINGS, CA 90670-4039
Phone: (562) 941-4507
FAX: (562) 941-8940
Toll-Free FAX: (800) 326-8940

SOUTHEAST WAREHOUSE FORTNEY SALES CO., INC. 4221 CANTRELL ROAD NW

ACWORTH, GA 30101
Phone: (770) 427-6528
FAX: (770) 423-9249
Toll Free FAX: (800) 423-9249
Web Site: www.fortneysales.com
E-Mail: sales@fortneysales.com

EASTERN WAREHOUSE EASTERN RUBBER & PLASTICS CO., INC. 100 GOLDMAN DR.

PLUMSTED INDUSTRIAL PARK
CREAM RIDGE, NJ 08514
Phone: (609) 758-0100
FAX: (609) 758-0102
Toll Free FAX: (800) 445-7138
Web Site: www.easternrubber.com
E-Mail: sales@easternrubber.com

IN MEXICO:

KURIYAMA DE MÉXICO S DE RL DE CV
AV JOSE PALOMO MARTINEZ NO 520-20
BODEGA 5
PARQUE INDUSTRIAL OMOLAP
APODACA, N.L. CP:66633, MÉXICO
Telefonos: (81) 1086-1870 O 71
Lada sin Costo 01 800 822 52 00
FAX: (81) 1086-1869
Internet: www.kuriyama.com
Correo Electronico: ventas@kuriyama.com



kuriyama.com/50years